

The all-new 2012 C-Class Coupe



Mercedes-Benz  
The best or nothing.



C 350 Coupe.



# The triumph of the open road.

As the very first coupe to bear the C-Class nameplate, the all-new 2012 C-Class Coupe is a dynamic expression of Mercedes-Benz passion. A true performance vehicle with a refined edge, its sleek yet aggressive contours turns heads as effectively as it does corners. Feel your heart rate rise with the speedometer – this is pure driving exhilaration.

## The C-Class Coupe

<b>DESIGN</b>	2
<b>ENTERTAINMENT &amp; COMMUNICATION</b>	8
<b>AGILITY</b>	10
<b>SAFETY</b>	14
<b>AMG</b>	16
<b>COLOURS &amp; MATERIALS</b>	20
<b>EQUIPMENT LISTING</b>	24
<b>ACCESSORIES &amp; TECHNICAL DATA</b>	26
<b>OWNERSHIP, WEBSITE &amp; TEST DRIVE</b>	28



C 350 Coupe.



## The picture of pure power, refined.

Attention to detail is central to Mercedes-Benz; and nowhere is it more evident than within the 2012 C-Class Coupe. With its AMG styled exterior – including 17" 5-spoke wheels on the C 250 and 18" AMG 7-spoke wheels on the C 350 – dynamically sloped coupe roofline accented by a wide, tinted panoramic sunroof, and striking cool-white LED daytime running lights – it's an expression of refined aggression, and a true work of art.

A close-up, high-angle view of the front passenger seat in a car. The seat is upholstered in a rich, reddish-brown leather with a perforated texture and double-stitching along the edges. The seat is positioned next to a black center console with a gear shifter and handbrake. In the background, the driver's seat and steering wheel are visible, along with the car's interior door panel and window. The view outside the window shows a vast, flat, open landscape under a clear sky.

## Well beyond practical.

The exceptional comfort of the interior appointed with ARTICO leather upholstery boasts pure luxury. Seating and steering wheel memory functionality allow ease of interior customization, creating a driving experience that conforms to you. Additionally, optional leather upholstery provides particular comfort to accompany all driving experiences.



C 350 Coupe Interior.



## When typical takes a detour.

Boasting two new engines including a 201 hp direct-injection four cylinder turbo in the C 250, and 302 hp direct-injection V6 in the C 350, the C-Class Coupe features exceptional fuel economy and incredible performance. An all-new full colour instrument cluster provides detailed vehicle information and the optional COMAND APS with HDD navigation and DVD player puts full control at your fingertips. Navigate with ease, access important vehicle information and engage entertainment functions seamlessly while remaining focused on the road.



C 350 Coupe.

## Get the show on the road.

Though just driving the C-Class Coupe is thrilling in itself, a number of other features provide you with entertainment while on the road. The MP3-compatible CD/DVD player features USB, optional iPod®, and auxiliary inputs – providing the confidence of versatility and adaptability. Additionally, the optional Media interface syncs with your iPod® music library providing the flexibility to browse artist album artwork through the vehicle's COMAND screen. Added Bluetooth audio streaming compatibility completes this innovative and trend setting entertainment and communication system.



9:59

Chicago

Ottawa

Toronto

100km



C 350 Coupe.



It never misses a beat.

At the heart of the C-Class Coupe is one of two powerful new engines. Powering the C 250 is the new direct-injection 4 cylinder turbo engine, with an impressive 201 horsepower and 229 lb-ft of torque. The C 350 adds even more power with the new direct-injection V6 with 302 horsepower and 273 lb-ft of torque, swiftly accelerating from 0-100 km/h in just 6 seconds.

## A curve in the road, a spike in adrenaline.

The C-Class Coupe's AGILITY CONTROL suspension handles the delicate balance between sport and refinement. Its selective damping system features dampers at each wheel, which constantly adjust between harder and softer absorption depending on the road conditions. The result is a noticeably smoother ride, even when the road is not.

Capable of completely transforming the driving dynamics is the Dynamic Handling Package – a standard on the C 350. With the simple push of a button, the C-Class Coupe can switch between sport and comfort styles, adjusting the damping system response, speed-sensitive power steering, ESP®/ASR traction control, accelerator response and the speed of automatic gear changes. Whatever the occasion calls for, you'll be more than prepared.

### What comes between you and the road.

The C-Class Coupe wheel options are designed with the same philosophy as the rest of this inspired vehicle. Style, substance and safety are the cornerstones of Mercedes-Benz, and none of them were spared while developing these impressive wheels.



17" 5-spoke wheels.<sup>1</sup>



18" AMG 7-spoke wheels.<sup>2</sup>



17" AMG 5 twin-spoke wheels.<sup>3</sup>



18" AMG 5 twin-spoke wheels.<sup>4</sup>



18" AMG 5 twin-spoke wheels.<sup>5</sup>



19" AMG multi-spoke wheels.<sup>6</sup>

<sup>1</sup>Standard on the C 250 Coupe. Not available on all other models. <sup>2</sup>Standard on the C 350 Coupe. Not available on all other models. <sup>3</sup>Available as part of the Sport Package on the C 250. Not available on all other models. <sup>4</sup>Available as a standalone option on the C 350 Coupe. Not available on all other models. <sup>5</sup>Standard on the C 63 AMG. Not available on all other models. <sup>6</sup>Available as a standalone option on the C 63 AMG. Not available on all other models.

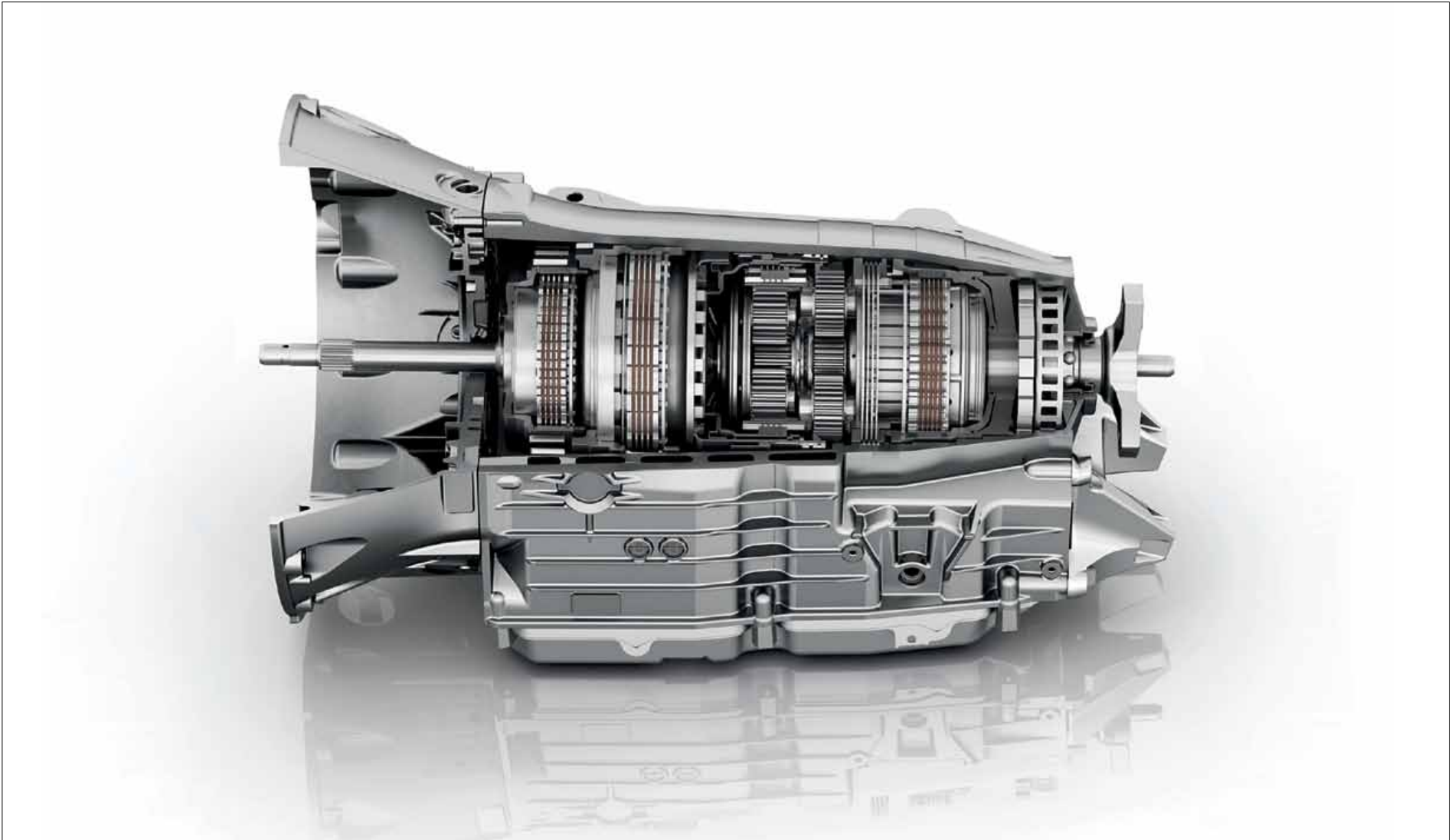

The 7G-TRONIC automatic transmission; one of over 18 million automatic transmissions produced in a period spanning more than 50 years.

## Safety should never be left to chance.

The integral safety concept from Mercedes-Benz is the guiding force behind a series of linked technologies that come into play in the critical moments before, during and after an accident. On the C-Class Coupe, the available Driving Assistance Package provides an even greater pre-empt against danger. Passive Blind Spot Assist<sup>1</sup> provides a visual warning if a vehicle is detected in the driver's blind spot. Passive Lane Keeping Assist<sup>1</sup> identifies when the driver is leaving the lane unintentionally. The driver is warned by means a vibration in the steering wheel. When reversing with little room to spare, PARKTRONIC<sup>2</sup> can assist by providing visual and audible signals to warn of a risk of collision. In the event of a collision, the TeleAid<sup>3</sup> emergency calling system automatically engages with the assistance of a live representative who can provide the critical assistance required.



The rear view camera makes parking easier when space is at a premium.



Passive Blind Spot Assist is available as part of the optional Driving Assistance Package.

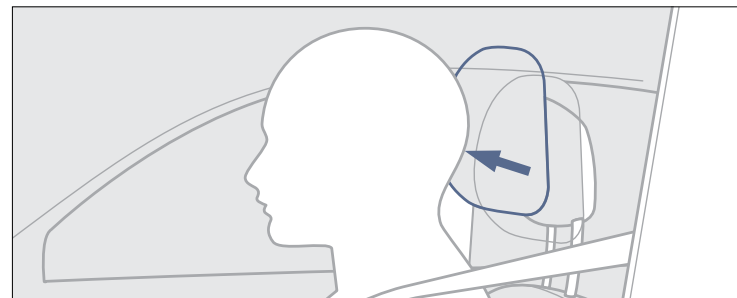

NECK-PRO head-restraints offering instant support and protection in the event of a collision.

<sup>1</sup>Available as part of the Driving Assistance Package. <sup>2</sup>Available as part of the Premium Package. <sup>3</sup>Subscription is required for service to be active. TeleAid operates only where cellular and Global Positioning System coverage is available.

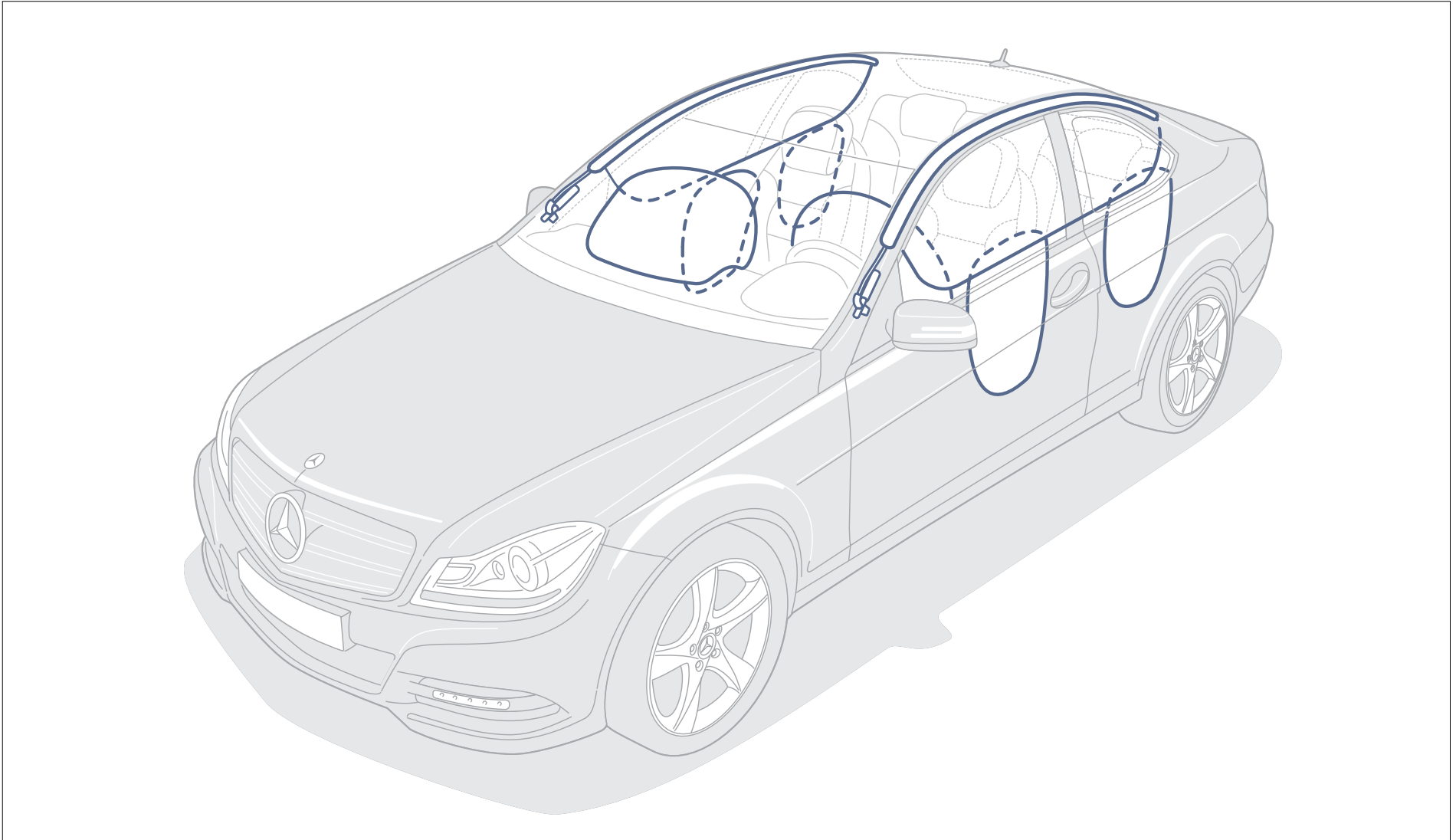

The energy-absorbing crumple zones in the front and rear sections and an extremely robust safety passenger cell form an effective defensive barrier in an emergency.



**AMG**

C 63 AMG in Diamond White.



## Evoking the spirit of racing tradition.

Confidence and character are rooted deep within the C 63 AMG. From the full colour instrument cluster to the newly designed steering wheel with a flat top and bottom, every inch of this vehicle has been carefully crafted to ensure a priority on performance. From exceptional acceleration to virtually seamless downshifting, the C 63 AMG is the ideal equation of refinement and performance.

The AMG Performance Package offers 30 additional horsepower, providing a remarkable total of 481 hp and top speed of 280 km/h.<sup>1</sup> Additional performance features include a limited-slip differential, tire pressure monitoring system and AMG trunk lid spoiler in carbon fibre.



19" AMG multi spoke wheels.



AMG trunk lid spoiler in carbon fibre.

## Dressed for the occasion.

The finishing touches can mean the difference between a work of art and a true masterpiece. Whichever colour you opt for, you've made the right choice. With a selection of paint finishes benefiting from an extra scratch-resistant clear coat, your C-Class is less susceptible not only to scratches, but also to sunlight, temperature variations, dust and soot.



ARTICO (Tone on Tone) <sup>1</sup>	Almond Beige/Mocha Brown	ARTICO (Tone on Black) <sup>1</sup>	Black/Black	Alpaca Grey/Black	LEATHER (TONE ON BLACK) <sup>2</sup>	Black/Black	Alpaca Grey/Black	Fiamenco Red/Black	Sahara Beige/Black	AMG <i>designo</i> NAPPA LEATHER <sup>3</sup>	Black - Single Tone	Sand/Black - Single Tone	Sand/Black - Two Tone	Classic Red/Black - Single Tone	Classic Red/Black - Two Tone	Porcelain/Black - Single Tone	Porcelain/Black - Two Tone
------------------------------------	--------------------------	-------------------------------------	-------------	-------------------	--------------------------------------	-------------	-------------------	--------------------	--------------------	-----------------------------------------------	---------------------	--------------------------	-----------------------	---------------------------------	------------------------------	-------------------------------	----------------------------

### SOLID

Black	●	●	●	●	●	●	●	●	●	●	●	●	●	●	●	●	●
Fire Opal	○	●	○	●	○	○	○	○	○	○	●	●	●	○	○	●	●
Calcite White	●	●	○	●	○	●	●	●	●	●	●	●	●	●	●	○	○
<b>METALLIC PAINT</b>																	
Obsidian Black	●	●	●	●	●	●	●	●	●	●	●	●	●	●	●	●	●
Magnetite Black	●	●	●	●	●	●	●	●	●	●	●	●	●	●	●	●	●
Cuprit Brown	●	○	△	○	△	△	●	○	●	○	△	△	△	△	△	△	△
Tenorite Grey																	
Iridium Silver	△	●	●	●	●	●	○	●	△	△	●	●	○	○	○	○	○
Palladium Silver	△	●	●	●	●	●	○	●	△	△	●	●	○	○	○	○	○
Diamond White	●	●	○	●	○	●	●	●	●	●	●	●	●	○	○	○	○
Cavansite Blue	●	●	●	●	●	△	●	●	●	●	●	●	△	△	●	●	●

● Recommended combination   ○ Possible Combination   △ Not a recommended combination

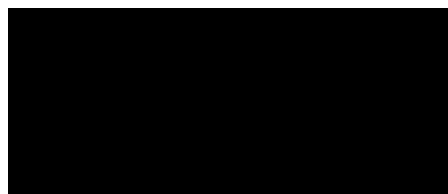
**SOLID**

040 Black



590 Fire Opal

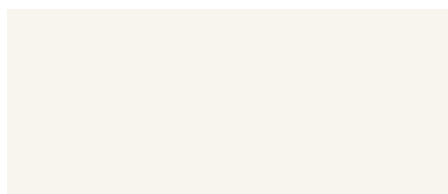

650 Calcite White

**METALLIC (OPTIONAL)**

197 Obsidian Black



183 Magnetite Black



497 Cuprit Brown



755 Tenorite Grey



775 Iridium Silver



792 Palladium Silver

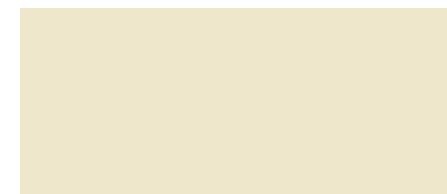

799 Diamond White



890 Cavansite Blue

**ARTICO (TONE ON TONE)<sup>1</sup>**



125 Almond Beige/Mocha Brown

**ARTICO (TONE ON BLACK)<sup>1</sup>**



121 Black/Black

**LEATHER (TONE ON BLACK)<sup>2</sup>**



221 Black/Black



237 Flamenco Red/Black



128 Alpaca Grey/Black

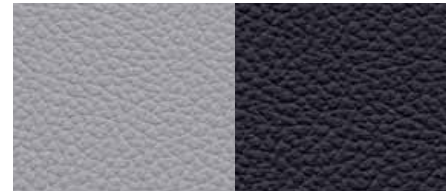

228 Alpaca Grey/Black



235 Sahara Beige/Black

<sup>1</sup>Available on the C 250 Coupe and C 350 Coupe. Not available on the C 63 AMG. <sup>2</sup>Available only on the C 350 Coupe. Not available on the C 250 Coupe and the C 63 AMG. <sup>3</sup>Available only on the C 63 AMG. Not available on the C 250 Coupe and C 350 Coupe. <sup>4</sup>Only available on the C 63 AMG Coupe.

**AMG *designo* NAPPA LEATHER<sup>3</sup>**

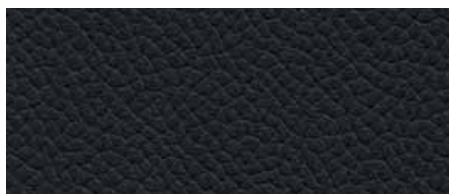

X11 Black - Single Tone



X83 Classic Red/Black - Two Tone

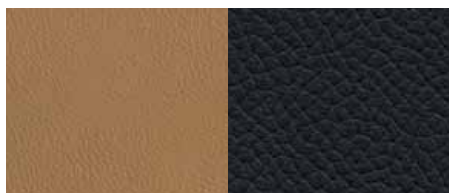

X10 Sand/Black - Single Tone

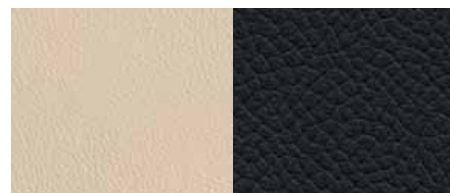

X27 Porcelain/Black - Single Tone

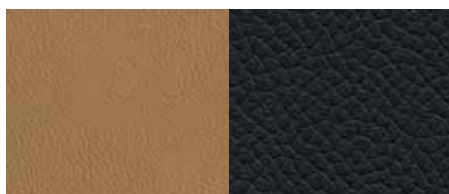

X77 Sand/Black - Two Tone

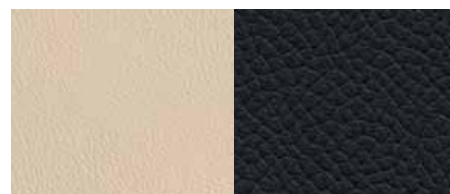

X87 Porcelain/Black - Two Tone

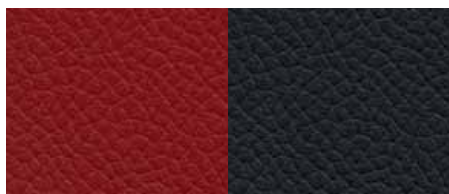

X17 Classic Red/Black - Single Tone

**TRIM**



731 Burl Walnut Wood Trim



H73 AMG Carbon Fibre Trim<sup>4</sup>



739 Aluminium

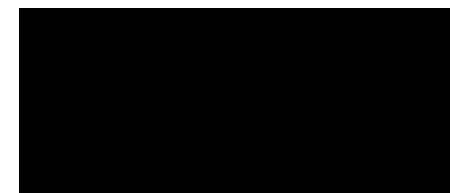

H80 Black Piano Lacquer Trim



H06 Ash Olive Wood (Matte)

## *designo.*

Exclusive paints. Fine cut leathers. Carefully crafted trims. Consider these the finishing touches of an automotive masterpiece. Made from only the highest quality materials, *designo* options add a whole new dimension to the new C 63 AMG's awe-inspiring design. Fitted as standard on the C 63 AMG, *designo* interior options result in a very attractive interior and compliment this exceptional vehicle with a character as distinguished as your own.

Visit [mercedes-benz.ca/designo](http://mercedes-benz.ca/designo) for additional details and configurator options.



C 63 AMG interior adorned in *designo* leather upholstery.



Exclusive appointments provide an unmatched interior character.

## INDIVIDUAL EQUIPMENT

## TRANSMISSION

7G-TRONIC 7-speed automatic transmission

AMG SPEEDSHIFT MCT 7-speed sports transmission

## TRACTION/STABILITY

## ADAPTIVE BRAKE

Dynamic handling package

AGILITY CONTROL suspension

Electronic stability program (ESP®) including ABS and Acceleration Skid Control (ASR)

Brake Assist (BAS)

## AUDIO/VISUAL/COMMUNICATION

Audio 20 – Radio with single CD and Bluetooth (MP3 compatible)

COMAND APS with HDD Navigation and DVD player

harman/kardon® LOGIC7® surround sound system

Media interface (with iPod®, USB and auxiliary connections)

SIRIUS Satellite Radio<sup>1</sup>

LINGUATRONIC voice control

## EXTERIOR

17" 5-spoke wheels (*all season performance tires*)17" AMG 5-twin spoke wheels (*all season performance tires*)18" AMG 7-spoke wheels (*all season performance tires*)18" AMG 5-twin spoke wheels (*all season performance tires*)18" AMG 5-twin spoke wheels (*performance tires*)

19" AMG wheels

19" AMG multi-spoke wheels

AMG styling package (front and rear apron)

C 250 Coupe  
C 350 Coupe  
C 63 AMG Coupe

▲ ▲ –

– – ▲

▲ ▲ ▲

○ ▲ –

▲ ▲ ▲

▲ ▲ ▲

▲ ▲ ▲

▲ ▲ ▲

○ ○ ○

○ ○ ○

△ ○ ▲

○ ○ ●

○ ○ ○

▲ – –

○ – –

– ▲ –

– △ –

– – ▲

– – ○

– – △

▲ ▲ ▲

## INDIVIDUAL EQUIPMENT

## EXTERIOR

Automatic headlamp activation

Active bi-xenon headlamps

LED daytime running lights and LED taillamps

Auto dimming mirrors (Rearview and Driver's Side)

Adaptive highbeam assist (AHA)

Electronic compass

Electronically adjustable power folding heated exterior mirrors

Heated windshield washer system

Rain sensing windshield wipers

Headlamp washers

Tinted glass

Power windows with express up and down

Remote trunk release

## INTERIOR

Power driver's seat with three position memory

Driver's side lumbar support

Heated front seats

Split folding rear seats

AMG carbon fibre trim

Leather covered steering wheel

Steering wheel shift paddles

Multi-function steering wheel with LCD display

Panoramic sunroof

THERMATIC automatic climate control

Power tilt and telescoping steering column with memory

C 250 Coupe  
C 350 Coupe  
C 63 AMG Coupe

▲ ▲ ▲

○ ▲ ▲

▲ ▲ ▲

○ ▲ ▲

○ ▲ ▲

○ ▲ ▲

▲ ▲ ▲

▲ ▲ ▲

▲ ▲ ▲

○ ▲ ▲

▲ ▲ ▲

▲ ▲ ▲

▲ ▲ ▲

▲ ▲ ▲

▲ ▲ ▲

△ ▲ ▲

▲ ▲ ▲

– – ○

▲ ▲ –

○ ▲ ▲

▲ ▲ ▲

▲ ▲ ▲

▲ ▲ ▲

▲ ▲ ▲

## INDIVIDUAL EQUIPMENT

## CONVENIENCE

Direct steering

PARKTRONIC with parking guidance

Integrated garage door opener

Cruise control

SmartKey remote with panic button

KEYLESS-GO

Rear view camera

## SAFETY

Seatbelt tensioners with belt force limiters and front seatbelt

Dual-stage front airbags, front side airbags, side window curtain airbags (front and rear), driver's knee airbag, pelvic airbags

NECK-PRO headrests

Anti-theft alarm system

First aid kit

TeleAid emergency calling system<sup>2</sup>

Tire pressure loss warning system

Tire pressure monitoring system

Passive Lane Keeping Assist

Passive Blind Spot Assist

Hill start assist

	C 250 Coupe	C 350 Coupe	C 63 AMG Coupe
Direct steering	○	▲	▲
PARKTRONIC with parking guidance	○	○	○
Integrated garage door opener	○	▲	▲
Cruise control	▲	▲	▲
SmartKey remote with panic button	▲	▲	▲
KEYLESS-GO	-	△	○
Rear view camera	-	△	○
Seatbelt tensioners with belt force limiters and front seatbelt	▲	▲	▲
Dual-stage front airbags, front side airbags, side window curtain airbags (front and rear), driver's knee airbag, pelvic airbags	▲	▲	▲
NECK-PRO headrests	▲	▲	▲
Anti-theft alarm system	▲	▲	▲
First aid kit	▲	▲	▲
TeleAid emergency calling system <sup>2</sup>	△	△	△
Tire pressure loss warning system	▲	▲	▲
Tire pressure monitoring system	-	-	○
Passive Lane Keeping Assist	○	○	○
Passive Blind Spot Assist	○	○	○
Hill start assist	▲	▲	▲

## EQUIPMENT PACKAGES

## C 250 PREMIUM PACKAGE:

Mirror package, PARKTRONIC with parking guidance, Integrated garage door opener, Electronic compass, Auto dimming mirrors (Rearview & driver's side), Exterior power folding mirrors, SIRIUS Satellite Radio<sup>1</sup>, harman/kardon<sup>®</sup> LOGIC7<sup>®</sup> surround sound system, Heated front seats.

## C 350 PREMIUM PACKAGE:

PARKTRONIC with parking guidance, LINGUATRONIC voice control, COMAND APS with HDD navigation and DVD player, Media interface, SIRIUS Satellite Radio<sup>1</sup>, harman/kardon<sup>®</sup> LOGIC7<sup>®</sup> surround sound system.

## C 63 AMG PREMIUM PACKAGE:

Rear view camera, PARKTRONIC with parking guidance, Passive Blind Spot Assist, Passive Lane Keeping Assist, LINGUATRONIC voice control, COMAND APS with HDD navigation and DVD player, harman/kardon<sup>®</sup> LOGIC7<sup>®</sup> surround sound system, KEYLESS-GO.

## SPORT PACKAGE:

Direct steering, Steering wheel shift paddles, Dynamic handling package, 17" AMG 5-spoke wheels.

## DRIVING ASSISTANCE PACKAGE:

Passive Blind Spot Assist, Passive Lane Keeping Assist.

## BI-XENON HEADLAMP PACKAGE:

Headlamp washers, Adaptive Highbeam Assist (AHA), Active Bi-Xenon headlamps.

## PREMIUM SEATING PACKAGE:

Memory passenger seat, Leather upholstery.

## AMG PERFORMANCE PACKAGE PLUS:

Additional horsepower, Electronic speed limiter deletion<sup>3</sup>, limited-slip rear differential, Tire pressure monitoring system, AMG carbon fibre trim, AMG trunk lid spoiler in carbon fibre, Red brake calipers.

	C 250 Coupe	C 350 Coupe	C 63 AMG Coupe
C 250 PREMIUM PACKAGE:	△	-	-
C 350 PREMIUM PACKAGE:	-	△	-
C 63 AMG PREMIUM PACKAGE:	-	-	△
SPORT PACKAGE:	△	-	-
DRIVING ASSISTANCE PACKAGE:	△	△	-
BI-XENON HEADLAMP PACKAGE:	△	-	-
PREMIUM SEATING PACKAGE:	-	△	-
AMG PERFORMANCE PACKAGE PLUS:	-	-	△

▲ Standard equipment   △ Optional equipment   ○ Optional as part of a package   - Not available

## The final touches.

Added nuances and unique refinements are just the things to make your C-Class Coupe a distinctively richer driving experience. Mercedes-Benz Genuine Accessories are designed and built to the highest standards for engineering, quality, style and function.



### Rear Spoiler

Add this rear spoiler for a more athletic look for your C-Class, and watch as it subtly accentuates the trunk lines of your vehicle. Tailor-made of high-quality material for quick installation and a perfect fit. Comes primed, ready for painting.



### Roof Rack Basic Carrier

Our basic carrier is an essential component for attaching a wide assortment of items to the top of your C-Class. After easy installation, you can securely attach and lock bicycles, ski and snowboard racks, or a cargo container (shown). (Racks and containers sold separately).



### Illuminated Door Sill Panels

The white illuminated Mercedes-Benz lettering is activated every time you open the door to get in or out. These illuminated door sill panels, in ground stainless steel, are a further “highlight” of the C-Class.



### Trunk Tray

Simple to clean, non-slip, and precision tailored to the load area, this odourless tray prevents loads from sliding around and protects the carpet from spills and dirt.

	<b>C 250 COUPE</b>	<b>C 350 COUPE</b>	<b>C 63 AMG COUPE</b>
Engine type	16V DOHC I4 Turbo	24V DOHC V6	32V DOHC V8
Total Displacement (cm <sup>3</sup> )	1,796 cm <sup>3</sup>	3,498 cm <sup>3</sup>	6,208 cm <sup>3</sup>
Net power	201 hp @ 5,500 rpm	302 hp @ 6,500 rpm	451 hp @ 6,800 rpm
Net torque	229 lb-ft @ 2,300 – 4,300 rpm	273 lb-ft @ 3,500 – 5,250 rpm	443 lb-ft @ 5,000 rpm
Acceleration <sup>1</sup> , 0–100 km/h	7.2 seconds	6.0 seconds	4.5 seconds
Approximate top speed <sup>2</sup>	210 km/h	210 km/h	250 km/h
Tires, front rear	225/45 R 17 245/40 R 17	225/40 R 18 255/35 R 18	235/40 R 18 255/35 R 18
Fuel economy <sup>3</sup> , city/highway estimate	9.7 – 6.4 L/100 km	10.9 – 7.0 L/100 km	16.1 – 10.4 L/100 km
Fuel tank capacity	66 litres (8 litre reserve)	66 litres (8 litre reserve)	66 litres (8 litre reserve)
Fuel requirement	Premium unleaded	Premium unleaded	Premium unleaded
Dimensions <sup>4</sup>			
Wheelbase	2,760 mm	2,760 mm	2,760 mm
Overall length	4,590 mm	4,590 mm	4,707 mm
Overall height	1,406 mm	1,406 mm	1,406 mm
Overall width – Mirrors Extended	1,997 mm	1,997 mm	1,997 mm
Curb weight	1,550 kg	1,615 kg	1,730 kg
Luggage Capacity	450 litres	450 litres	450 litres

## A passion for things done right.

A passion for craftsmanship and attention to detail – it's what you'd expect from Mercedes-Benz, and it drives us to set new standards in design, performance, comfort and safety. To continually build on the legendary traditions of Mercedes-Benz, and to provide you with an ownership experience that includes the valuable benefits described below.

### **24-hour Roadside Assistance**

During the basic warranty coverage of 48 months and the time duration of the optional Extended Limited Warranty, Mercedes-Benz Roadside Assistance will be at your service. We'll bring you some gas, replace a flat tire with your spare, or jumpstart your car. In the event of a mechanical breakdown, if attempts by our Roadside Assistance technician have not made your vehicle safely operable, towing service will be provided to the nearest Mercedes-Benz dealership. Assistance is available 24 hours a day, every day, to anyone driving a Mercedes-Benz anywhere in Canada or the continental U.S.<sup>1</sup>

### **Wear and tear period**

The following parts listed are covered for wear and tear during the first 24 months or 40,000 km, whichever comes first. Brake pads, brake discs, brake pad wear sensors and light bulbs.

### **Mercedes-Benz warranties**

The Mercedes-Benz New Vehicle Limited Warranty covers defects in materials or workmanship for 48 months or 80,000 km, whichever comes first. To widen your window of confidence, you can opt for a Mercedes-Benz Extended Limited Warranty as well.<sup>2</sup>

### **Customer service**

Owning a Mercedes-Benz means that when you have a question, we're here to help. Customer Service is open from 9 a.m. to 5 p.m. EST, Monday through Friday, and is staffed with knowledgeable Mercedes-Benz experts who can talk you through the finer points of working your car's audio system – or even assist you in locating the nearest Mercedes-Benz dealership. Just call 1-800-387-0100. It's that simple.

### **Trip interruption reimbursement**

If a breakdown covered by your New Vehicle Limited Warranty or optional Extended Limited Warranty occurs more than 80 km from your home, leaves your Mercedes-Benz vehicle inoperable or unsafe to drive, and requires overnight repairs, we've got you covered. You will be reimbursed up to \$500 for hotel accommodations and up to \$600 for alternative travel expenses per incident while your car is being repaired at an authorized Mercedes-Benz dealership.

<sup>1</sup>Vehicle must be accessible from main roads. Roadside Assistance may involve charges for parts, service and towing. Depending on the circumstances, these services may be provided by an outside service provider, courtesy of Mercedes-Benz Roadside Assistance. For full details of the Roadside Assistance Program, please see your dealer. <sup>2</sup>Please see your dealer for warranty details as well as for terms, conditions and pricing for extended warranty options.

## Mercedes-Benz is virtually yours.

Visit [mercedes-benz.ca](http://mercedes-benz.ca) and open an online window to Mercedes-Benz Canada. Revel in the incredible photography of our vehicles and get a visceral impression of what it would be like to see yourself behind the wheel. Access information about any of our vehicles, including financing and leasing options, upcoming models, and configure your dream Mercedes online. Our website also offers details about the Mercedes-Benz Extended Limited Warranty, vehicle ownership, and much more on the fascinating story behind one of the world's most recognizable brands.

## To be continued. With a test drive.

Nowhere is your C-Class so convincing as on the road. It's only there that you can fully experience the superior handling and power that makes this car so special. Feel the engine move you forward, and watch your heart rate rise with the speedometer. That unique feeling in your stomach cannot be put down on paper. That's why we would like to invite you in for a test drive at your local Mercedes-Benz dealer. Reserve your appointment today, or visit [mercedes-benz.ca](http://mercedes-benz.ca).



© 2011 Mercedes-Benz Canada Inc.

All illustrations and specifications contained in this brochure are based on the latest product information available at the time of publication. Mercedes-Benz Canada reserves the right to make changes at any time, without notice, in colours, materials, equipment, specifications and models. Any inaccuracies in colours shown are due to reproduction variations of the printing process. Some vehicles may be shown with non-Canadian equipment. Some vehicles may be shown without side marker lights. Some vehicles are shown with optional equipment available at extra cost. Some optional equipment may not be available on all models. For current information regarding the range of models, standard features, optional equipment and/or colours available in Canada and their pricing, contact your nearest authorized Mercedes-Benz dealer or visit [mercedes-benz.ca](http://mercedes-benz.ca). harman/kardon® and LOGIC7® are registered trademarks of Harman International Industries Inc. iPod® is a registered trademark of Apple Computer, Inc.

Printed in Canada  
MBC-11-CC12-10150E

Mercedes-Benz Canada Inc. 98 Vanderhoof Avenue, Toronto, Ontario M4G 4C9  
1-800-387-0100

[www.mercedes-benz.ca](http://www.mercedes-benz.ca)

