

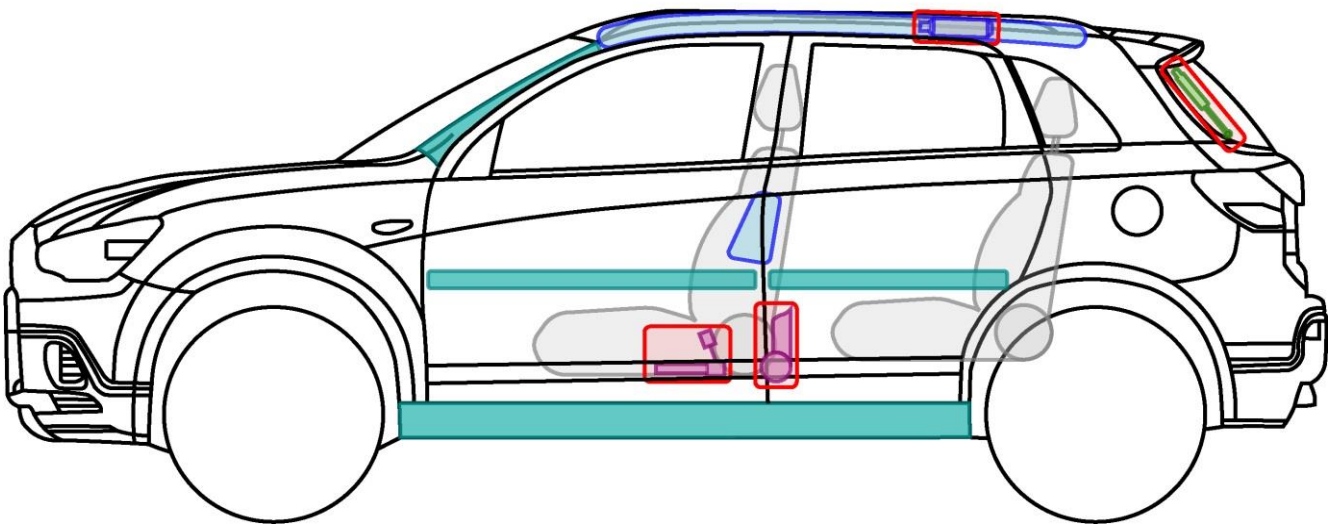

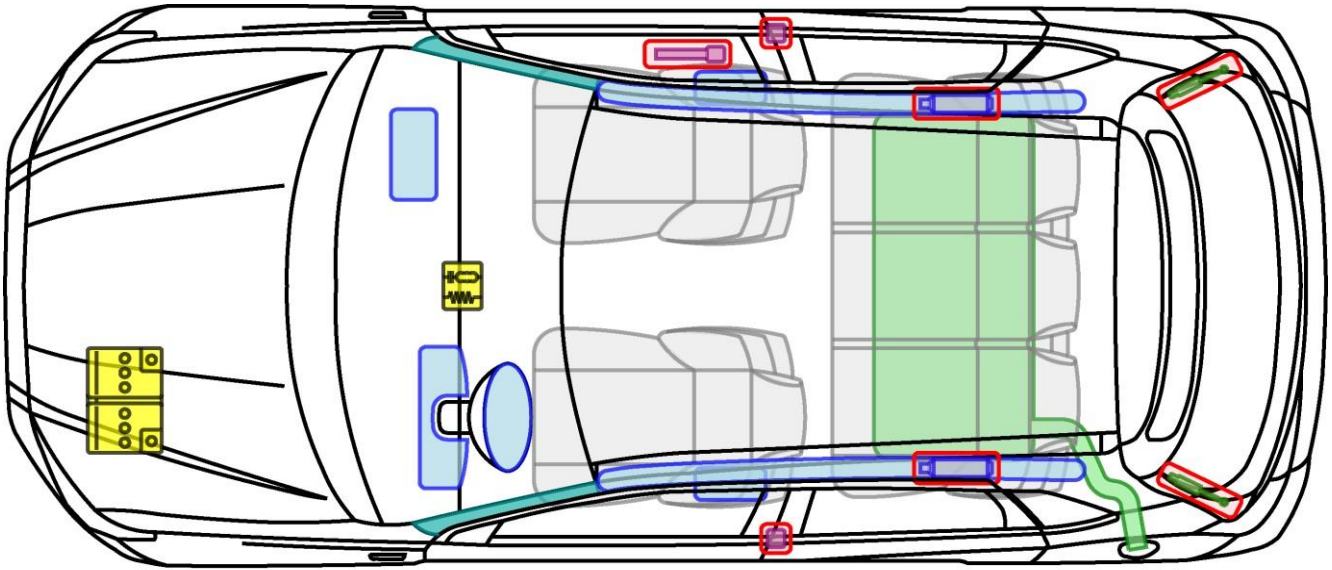

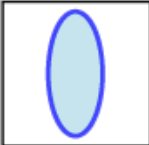



RETTUNGSDATENBLÄTTER

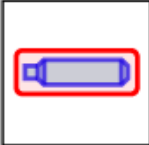







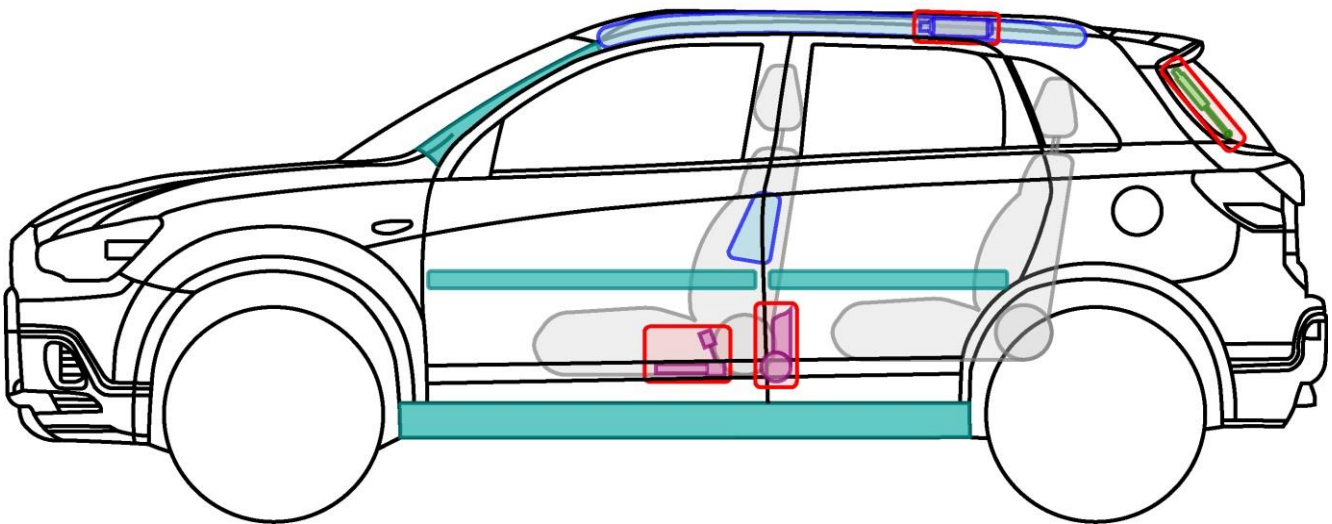
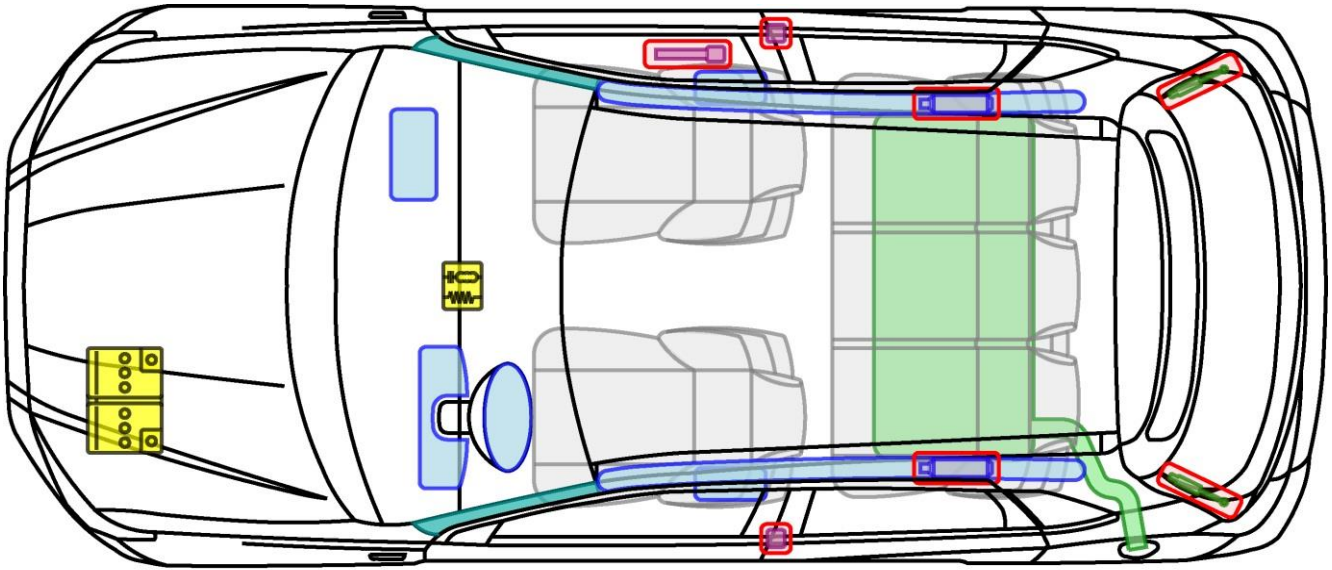

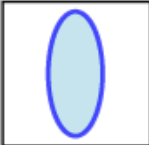

Legende

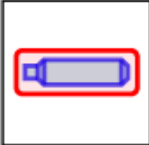
	Airbag		Karosserie- verstärkung		Steuergerät
	Gas- generator		Überroll- schutz		Batterie
	Gurt- straffer		Gasdruck- dämpfer		Kraftstoff- tank







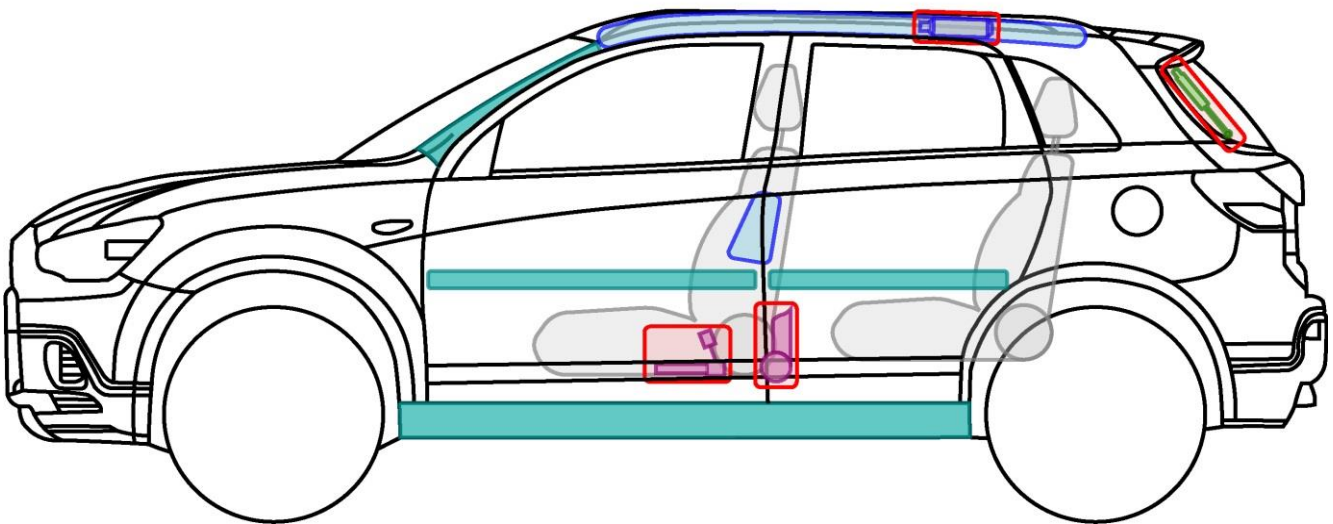
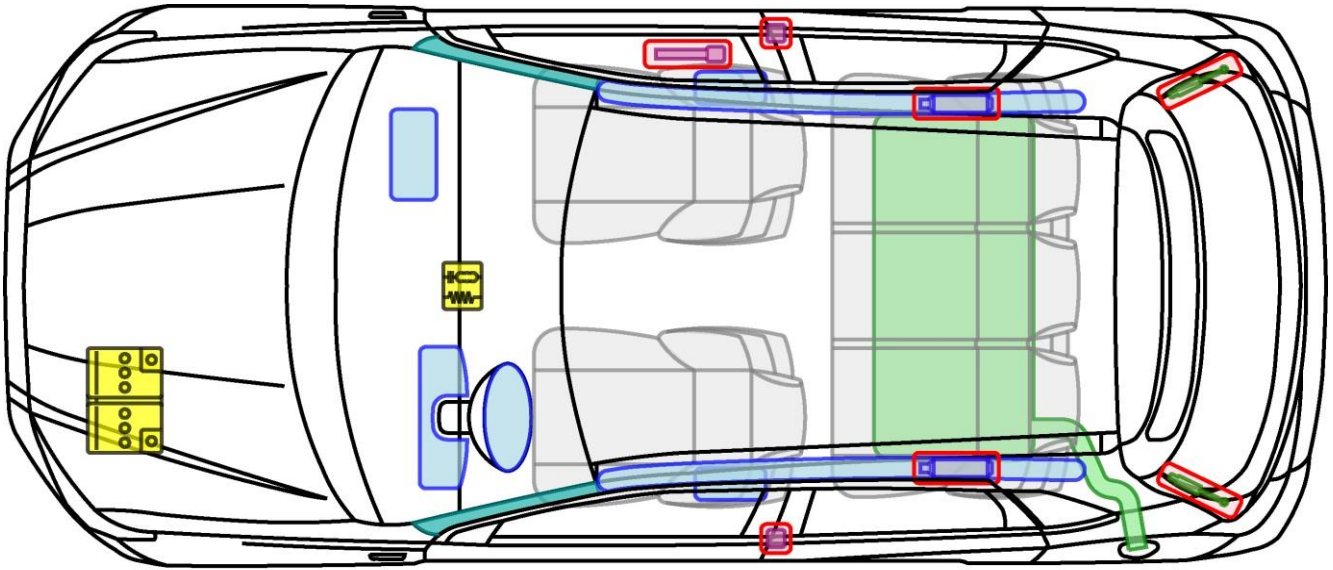



Legende

	Airbag		Karosserie- verstärkung		Steuergerät
	Gas- generator		Überroll- schutz		Batterie
	Gurt- straffer		Gasdruck- dämpfer		Kraftstoff- tank







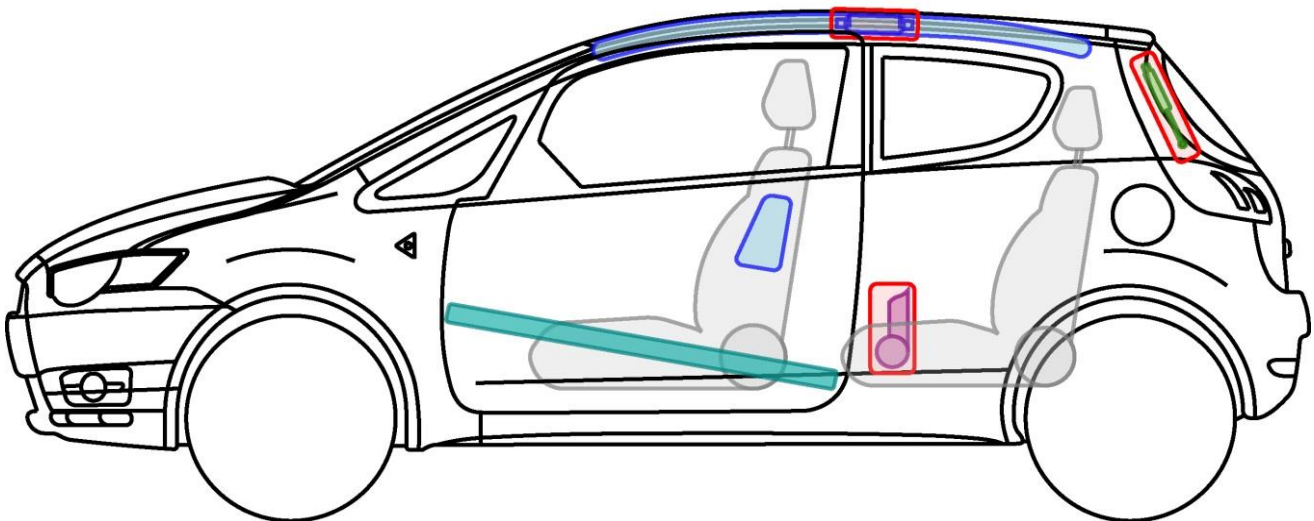
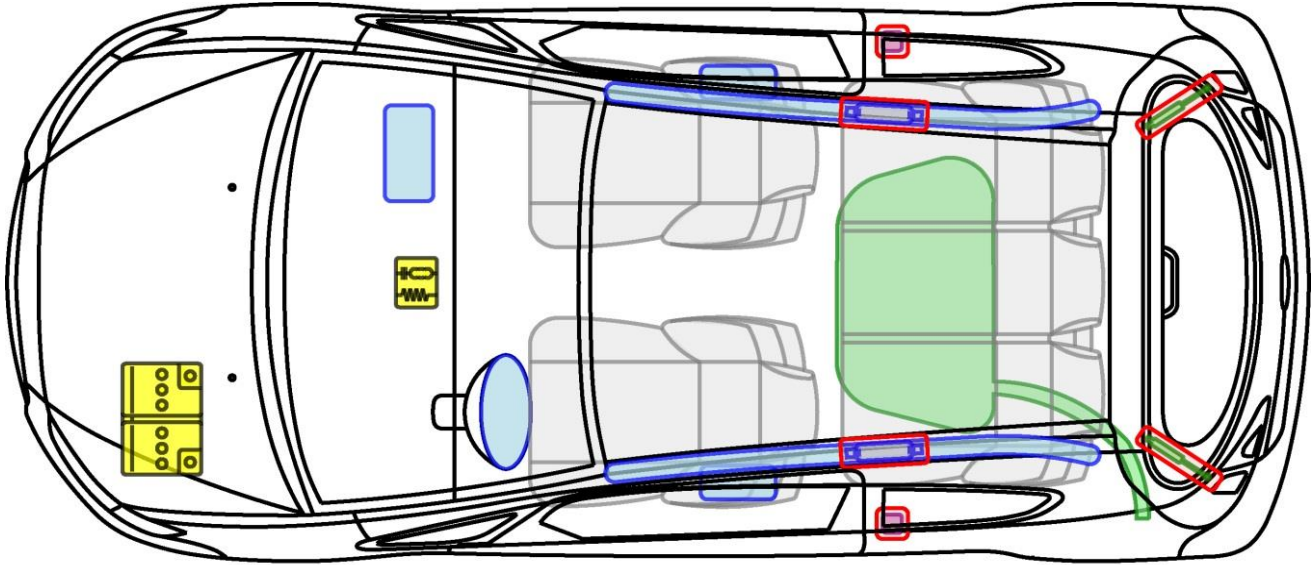

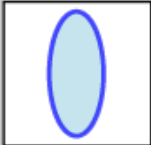

Legende

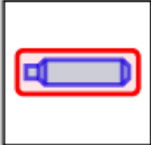
	Airbag		Karosserie- verstärkung		Steuergerät
	Gas- generator		Überroll- schutz		Batterie
	Gurt- straffer		Gasdruck- dämpfer		Kraftstoff- tank



Legende







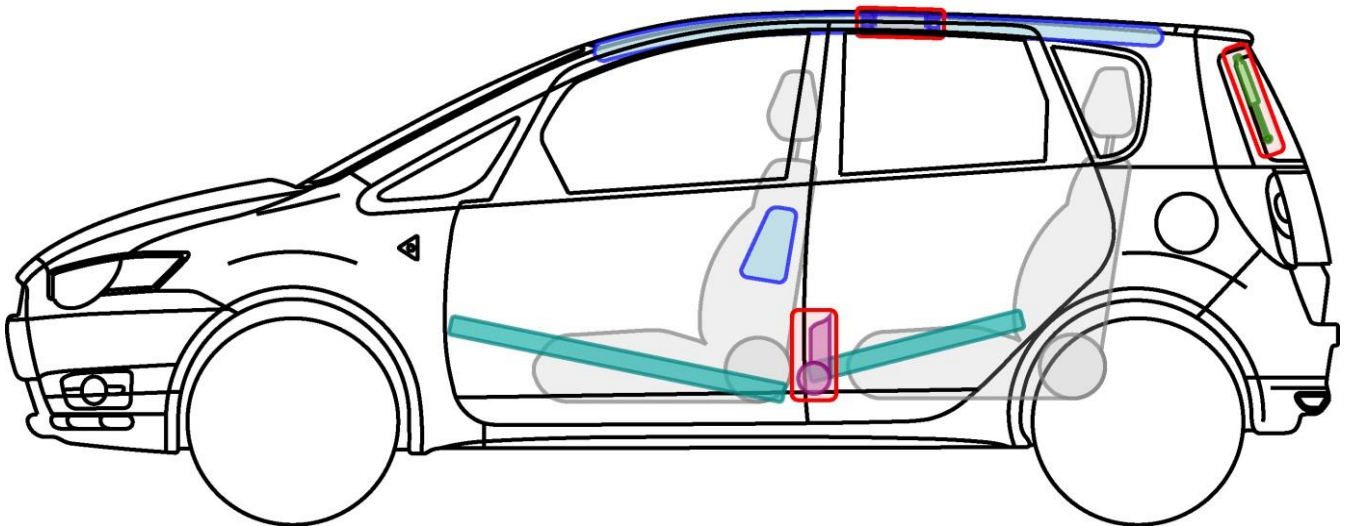
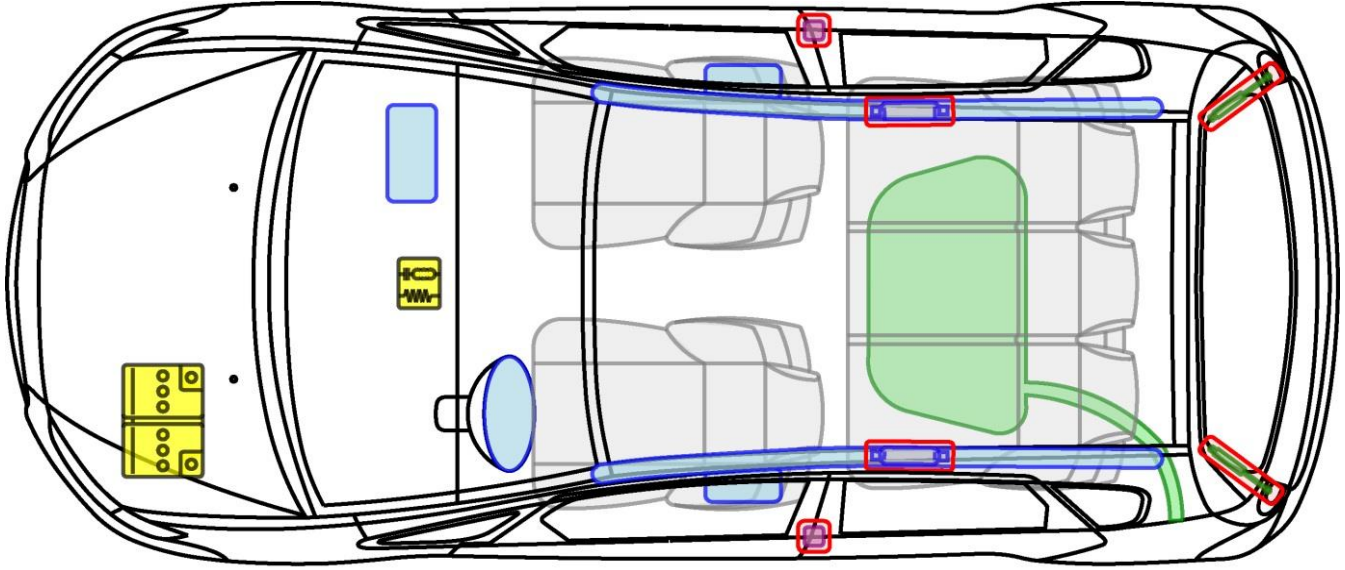

	Airbag		Karosserie- verstärkung		Steuergerät
	Gas- generator		Überroll- schutz		Batterie
	Gurt- straffer		Gasdruck- dämpfer		Kraftstoff- tank

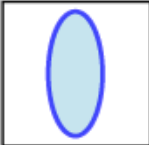
COLT 5türer

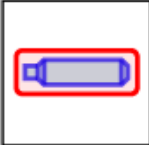
Typ: Z30, ab Modelljahr 2009







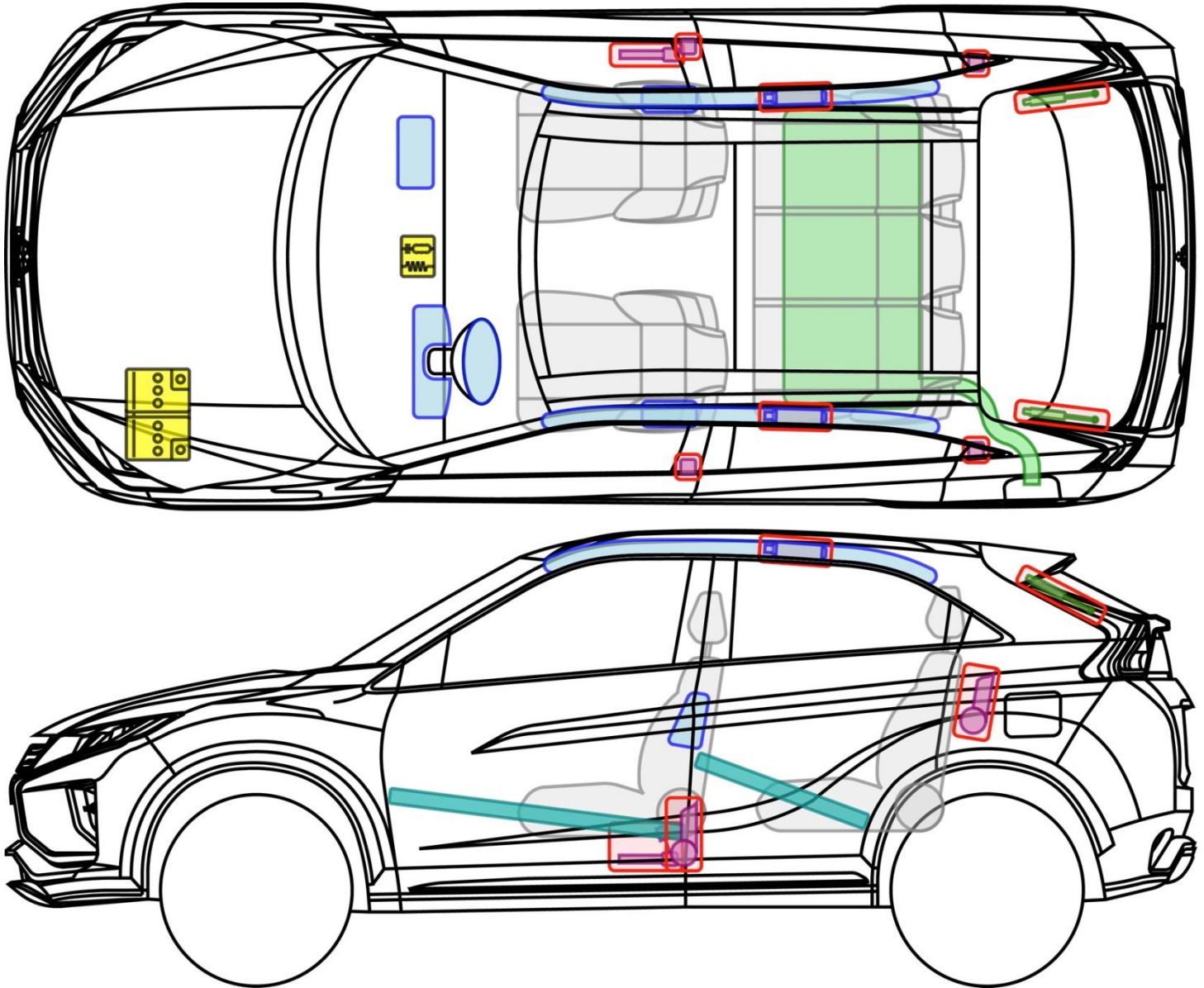



Legende

	Airbag		Karosserie- verstärkung		Steuergerät
	Gas- generator		Überroll- schutz		Batterie
	Gurt- straffer		Gasdruck- dämpfer		Kraftstoff- tank







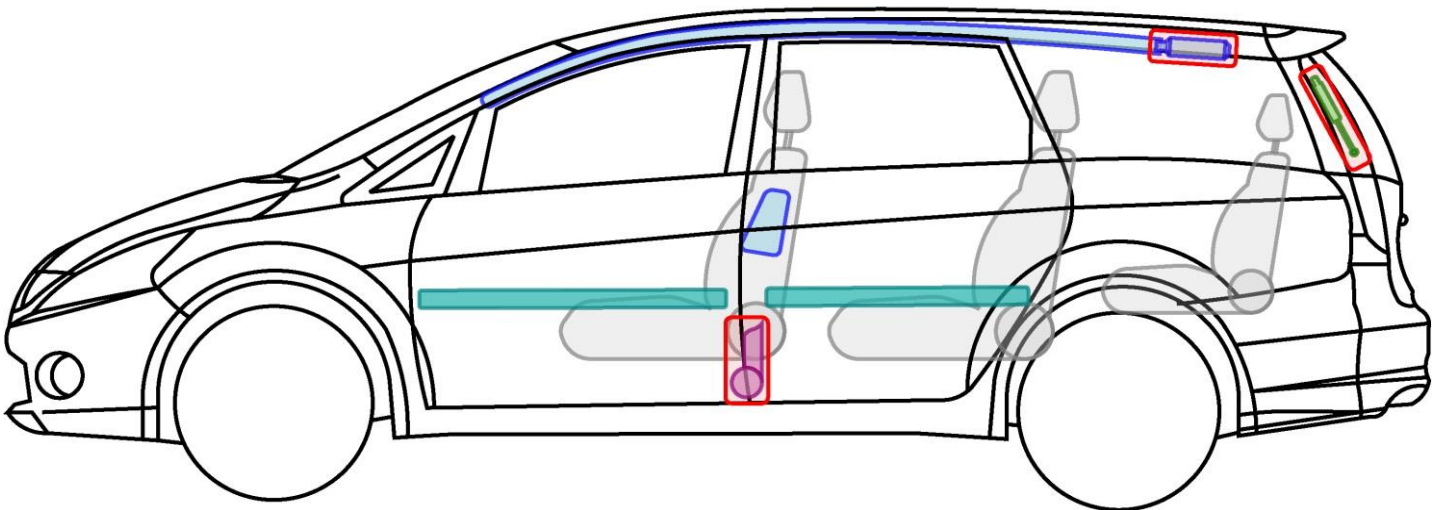
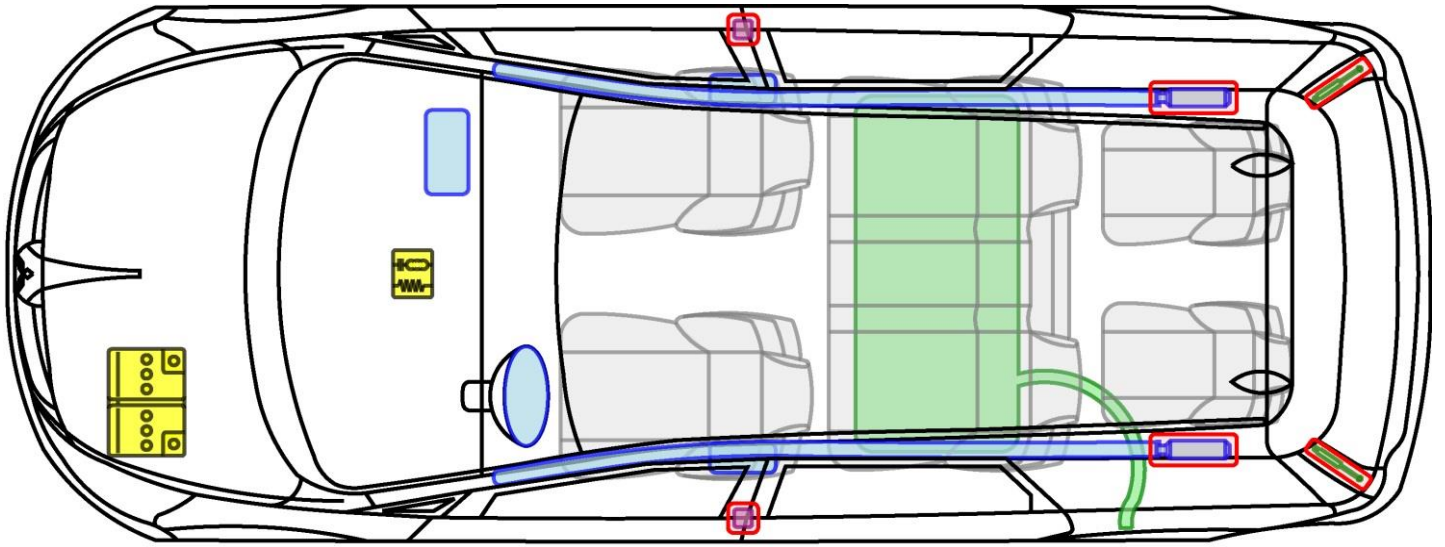

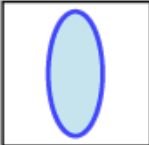

Legende

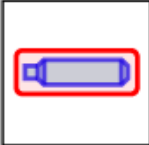
	Airbag		Karosserie- verstärkung		Steuergerät
	Gas- generator		Überroll- schutz		Batterie
	Gurt- straffer		Gasdruck- dämpfer		Kraftstoff- tank



Legende







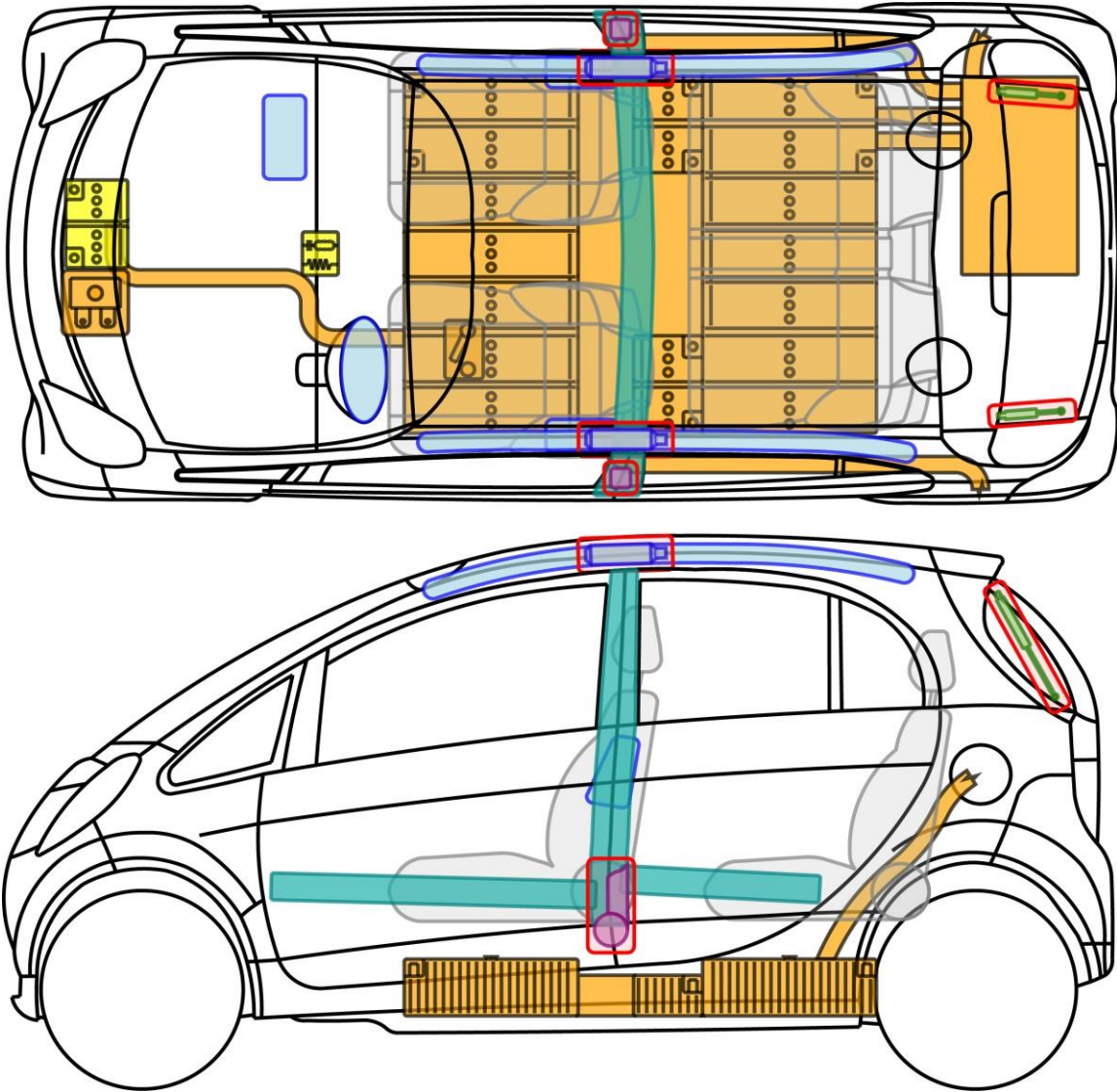

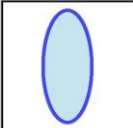

	Airbag		Karosserie- verstärkung		Steuergerät
	Gas- generator		Überroll- schutz		Batterie
	Gurt- straffer		Gasdruck- dämpfer		Kraftstoff- tank

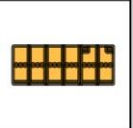
Electric Vehicle (i-MiEV)

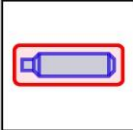
Typ: HA0 ab Modelljahr 2011

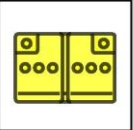

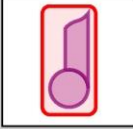
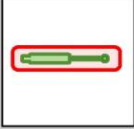
Legende

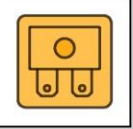
	Airbag		Karosserie- verstärkung		Steuergerät		Hochvolt- batterie		Hochvolt- Trennstelle
	Gas- generator		Überroll- schutz		12 V Batterie		Hochvolt -leitung/ -komponente		
	Gurt- straffer		Gasdruck- dämpfer		Kraftstoff- tank		Sicherungs- kasten		



Allgemeine Hinweise

- Bei Unfällen mit Airbag und/oder Gurtstrafferauslösung wird der Fahrzeugantrieb automatisch deaktiviert. Die Rückhaltesysteme sind weiterhin aktiv.
- Hochvoltkomponenten im Fahrzeug sind mit eindeutigen Warnaufklebern gekennzeichnet. Hochvoltkabel verfügen über eine orangefarbene Isolierung.
- Die Deaktivierungszeit bis zur vollständigen Deaktivierung der Rückhaltesysteme (Airbag, Gurtstraffer) beträgt **1 Minute** nach Durchführung der Deaktivierungsschritte.
- Die Deaktivierungszeit bis zur vollständigen Deaktivierung des Antriebs beträgt **5 Minuten** nach Durchführung der Deaktivierungsschritte.
- Vor Beginn von Arbeiten am Fahrzeug Ladestecker ziehen!

Fahrzeug gegen wegrollen sichern

- Gangwahlhebel in Stellung „P“ bringen.
- Feststellbremse betätigen.

Antrieb/Rückhaltesysteme deaktivieren

Methode 1 (Zündung zugänglich)

1. Zündschlüssel in Stellung „Aus“ drehen
2. 12 Volt Batterie abklemmen





Antrieb/Rückhaltesysteme deaktivieren





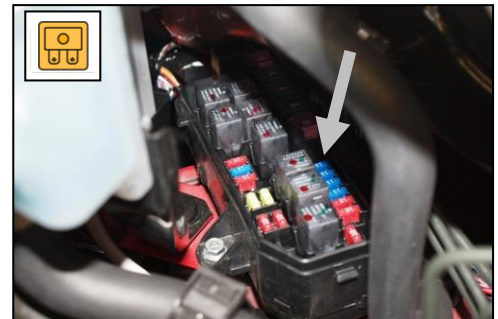
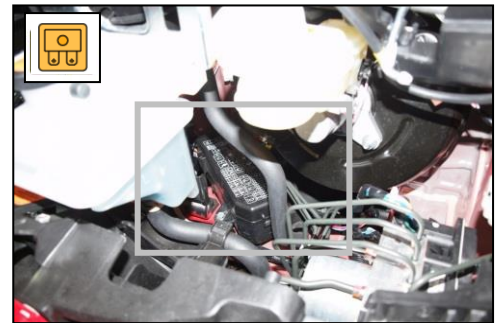

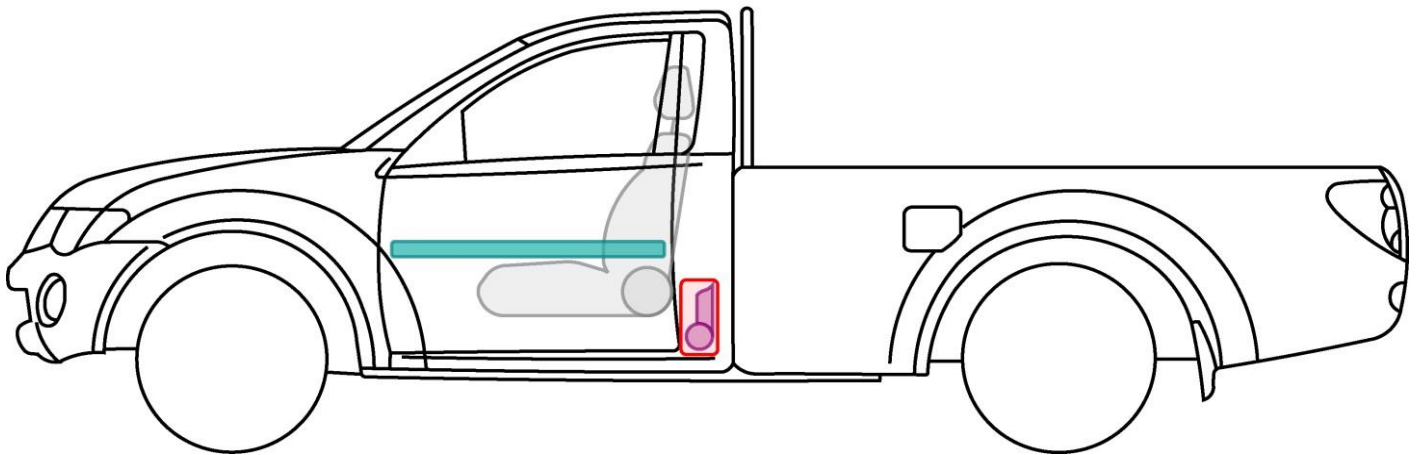
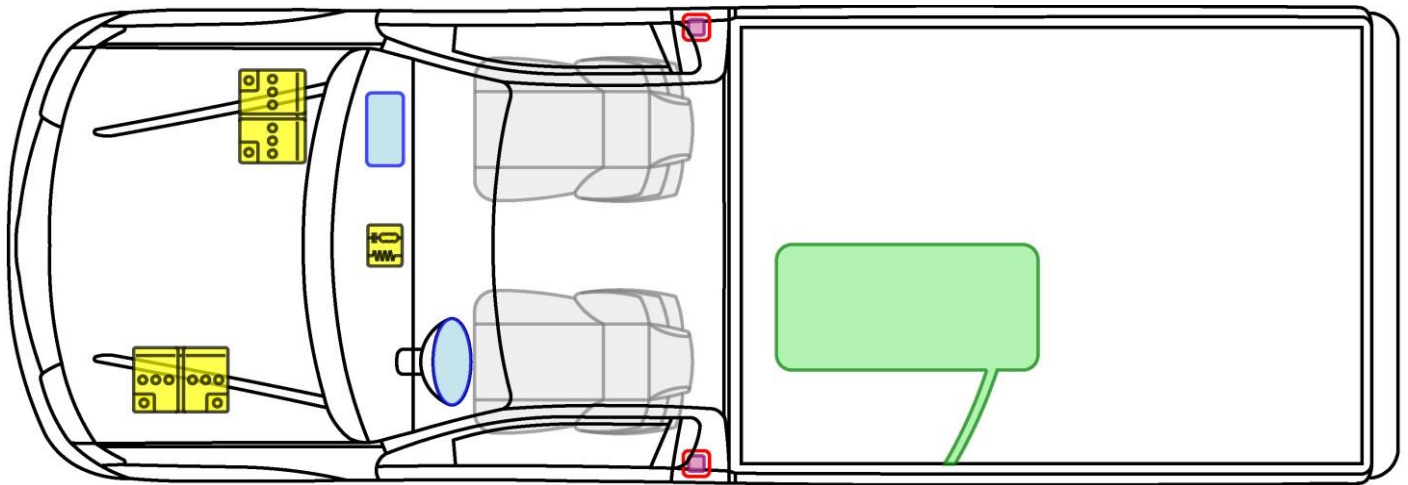

Methode 2 (Zündung nicht zugänglich)

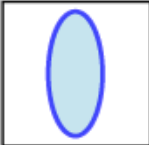
1. Sicherungskasten lokalisieren
2. „Power Control Unit“-Sicherung entfernen (Nr. 7, 15 A)
3. 12 Volt Batterie abklemmen

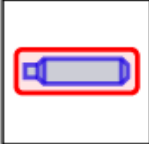







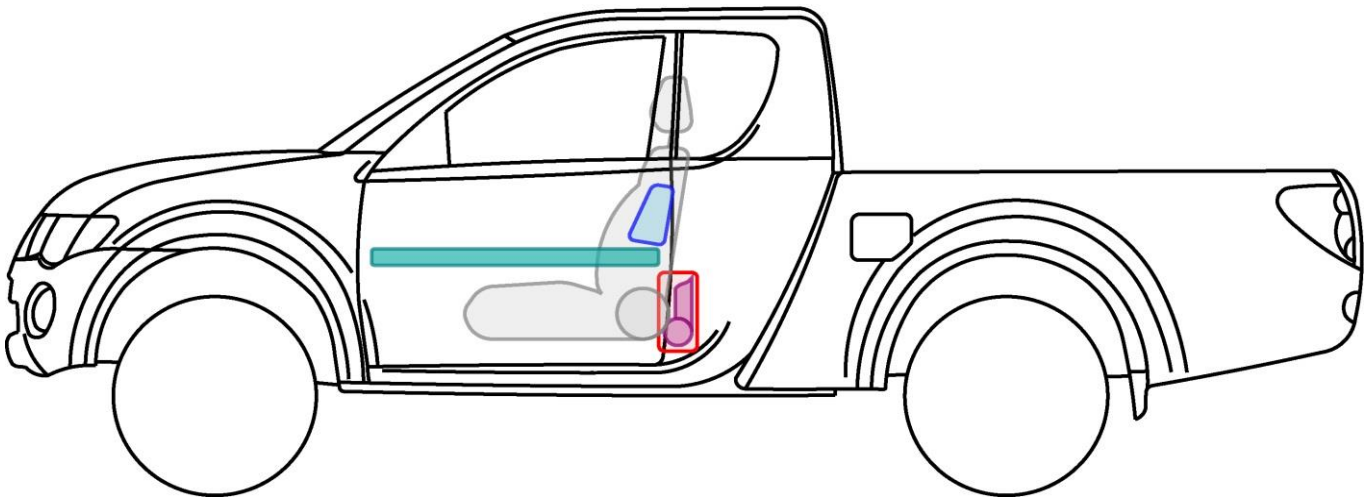
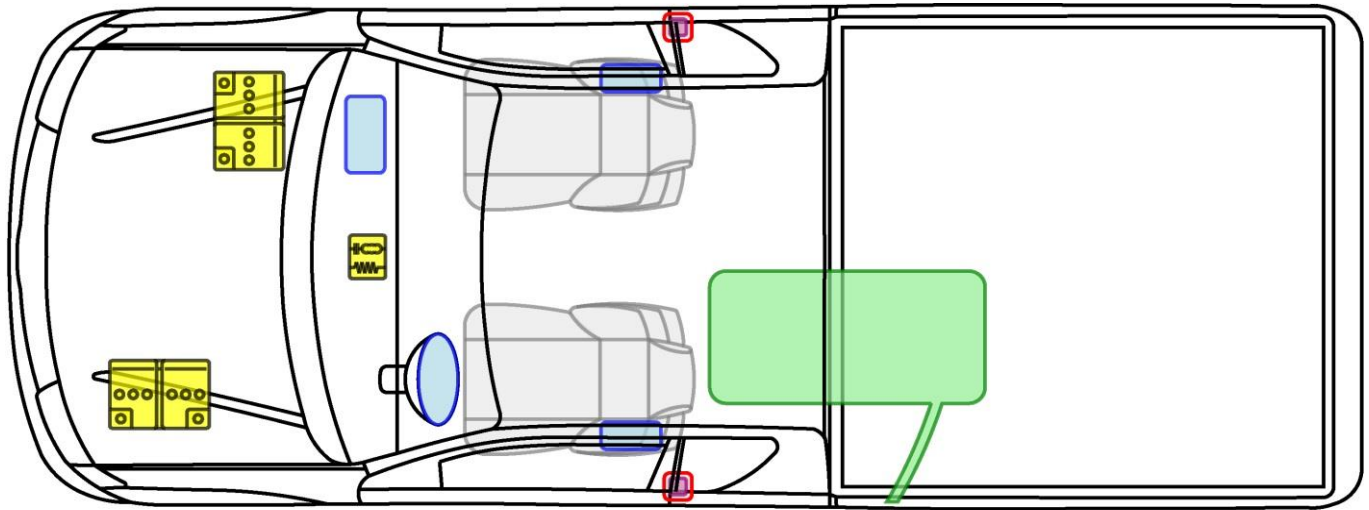



Legende

	Airbag		Karosserie- verstärkung		Steuergerät
	Gas- generator		Überroll- schutz		Batterie
	Gurt- straffer		Gasdruck- dämpfer		Kraftstoff- tank







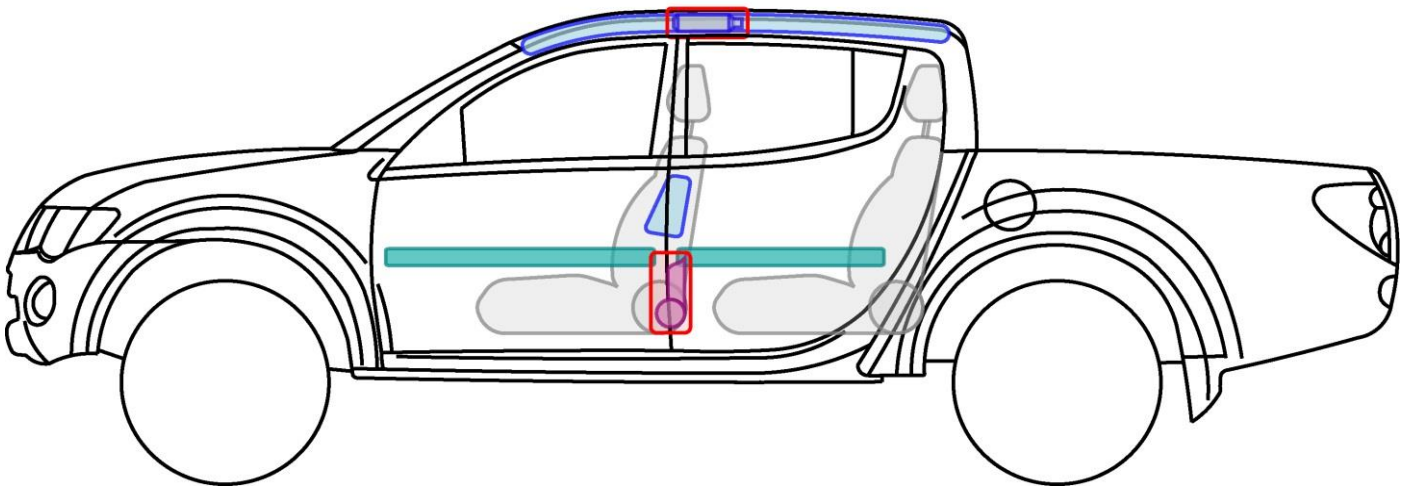
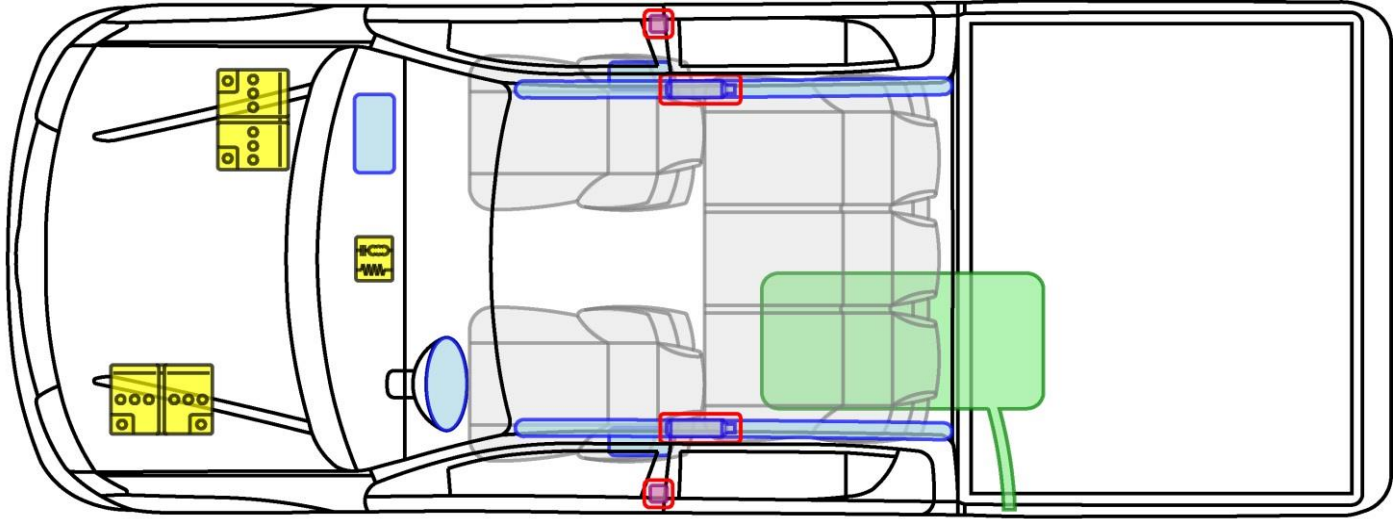



Legende

	Airbag		Karosserie- verstärkung		Steuergerät
	Gas- generator		Überroll- schutz		Batterie
	Gurt- straffer		Gasdruck- dämpfer		Kraftstoff- tank







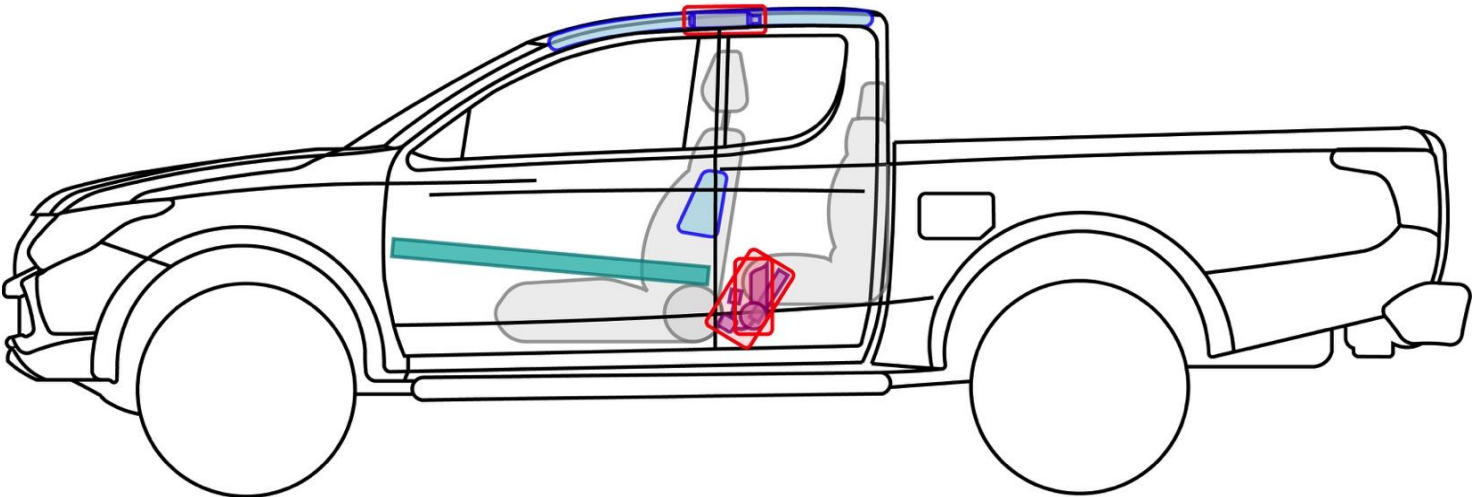
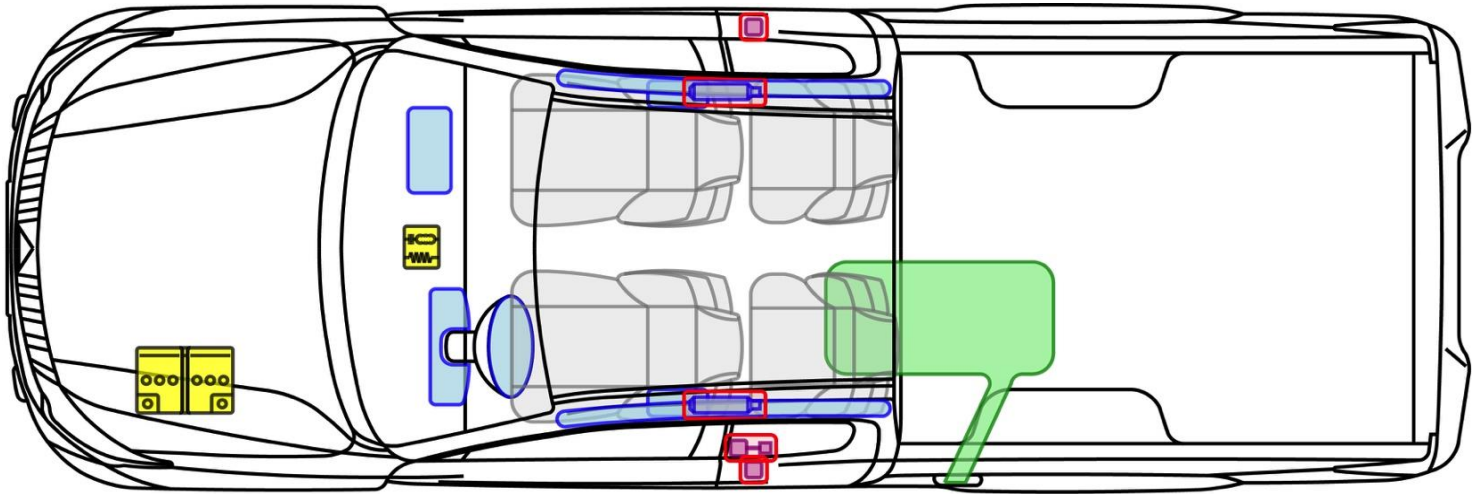

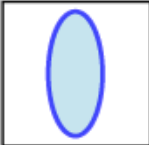

Legende

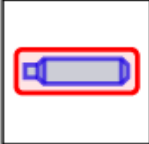
	Airbag		Karosserie- verstärkung		Steuergerät
	Gas- generator		Überroll- schutz		Batterie
	Gurt- straffer		Gasdruck- dämpfer		Kraftstoff- tank







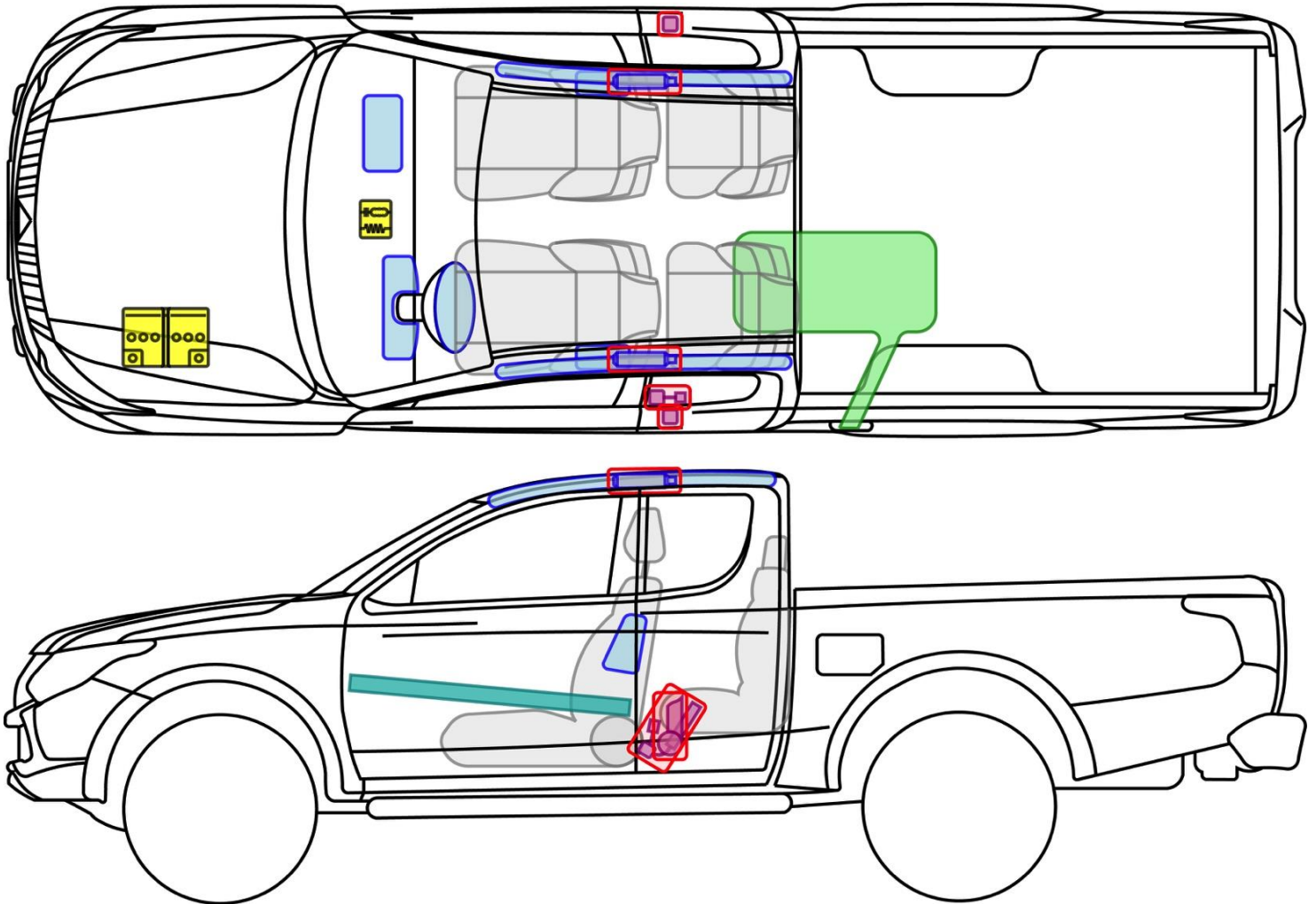



Legende

	Airbag		Karosserie- verstärkung		Steuergerät
	Gas- generator		Überroll- schutz		Batterie
	Gurt- straffer		Gasdruck- dämpfer		Kraftstoff- tank







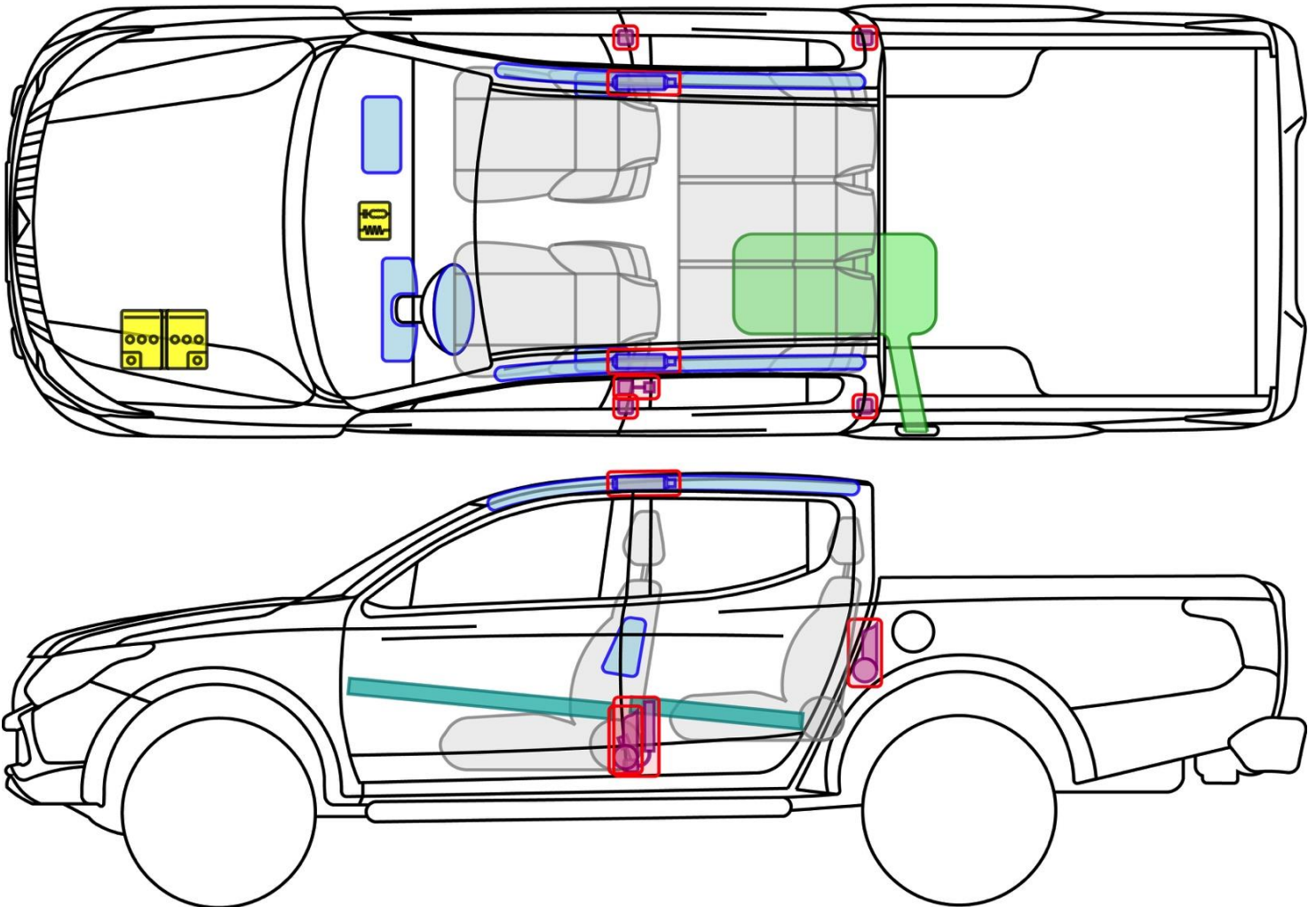

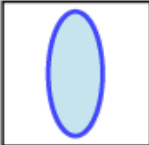

Legende

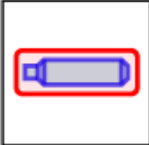
	Airbag		Karosserie- verstärkung		Steuergerät
	Gas- generator		Überroll- schutz		Batterie
	Gurt- straffer		Gasdruck- dämpfer		Kraftstoff- tank







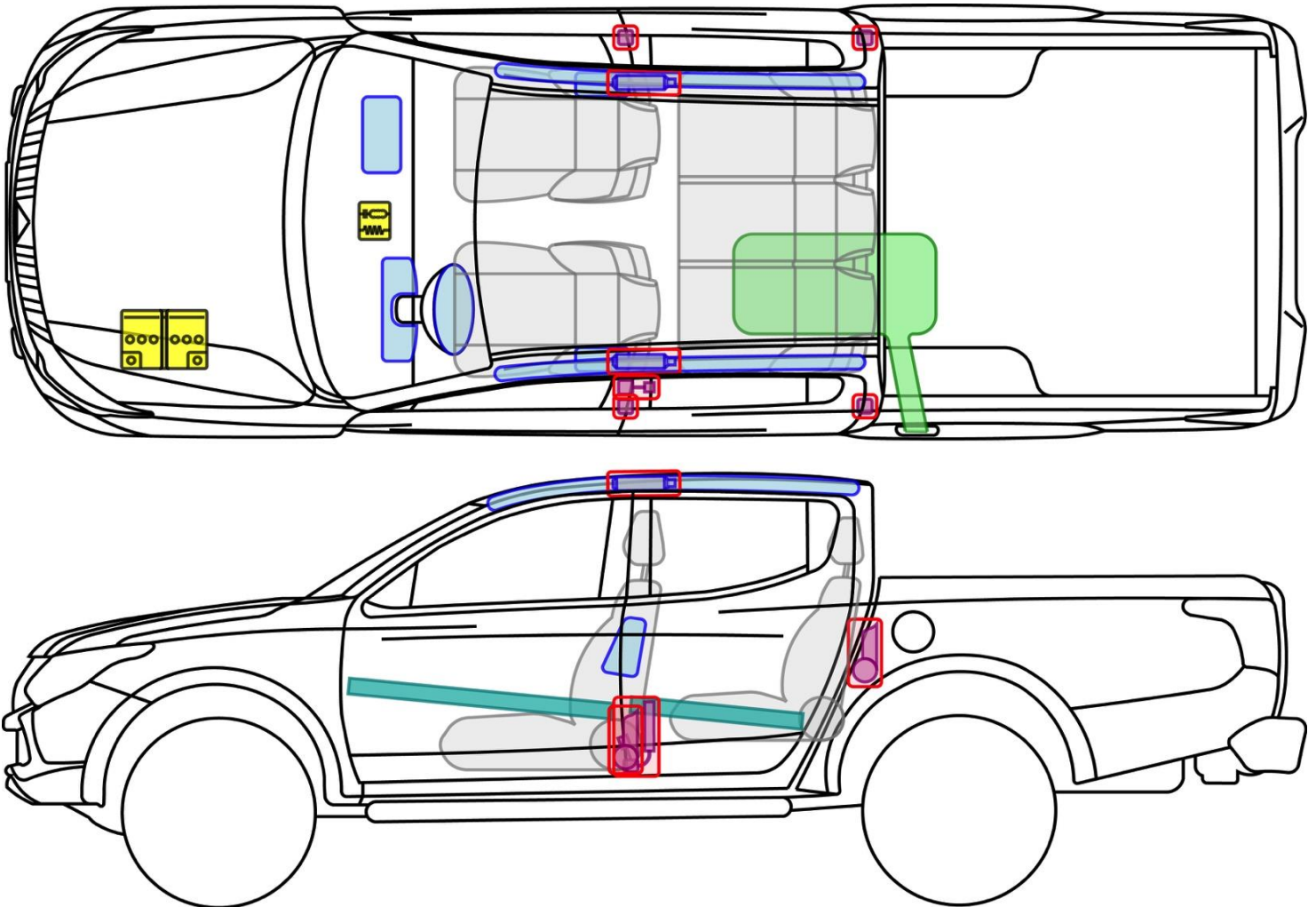

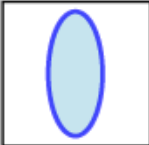

Legende

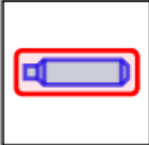
	Airbag		Karosserie- verstärkung		Steuergerät
	Gas- generator		Überroll- schutz		Batterie
	Gurt- straffer		Gasdruck- dämpfer		Kraftstoff- tank







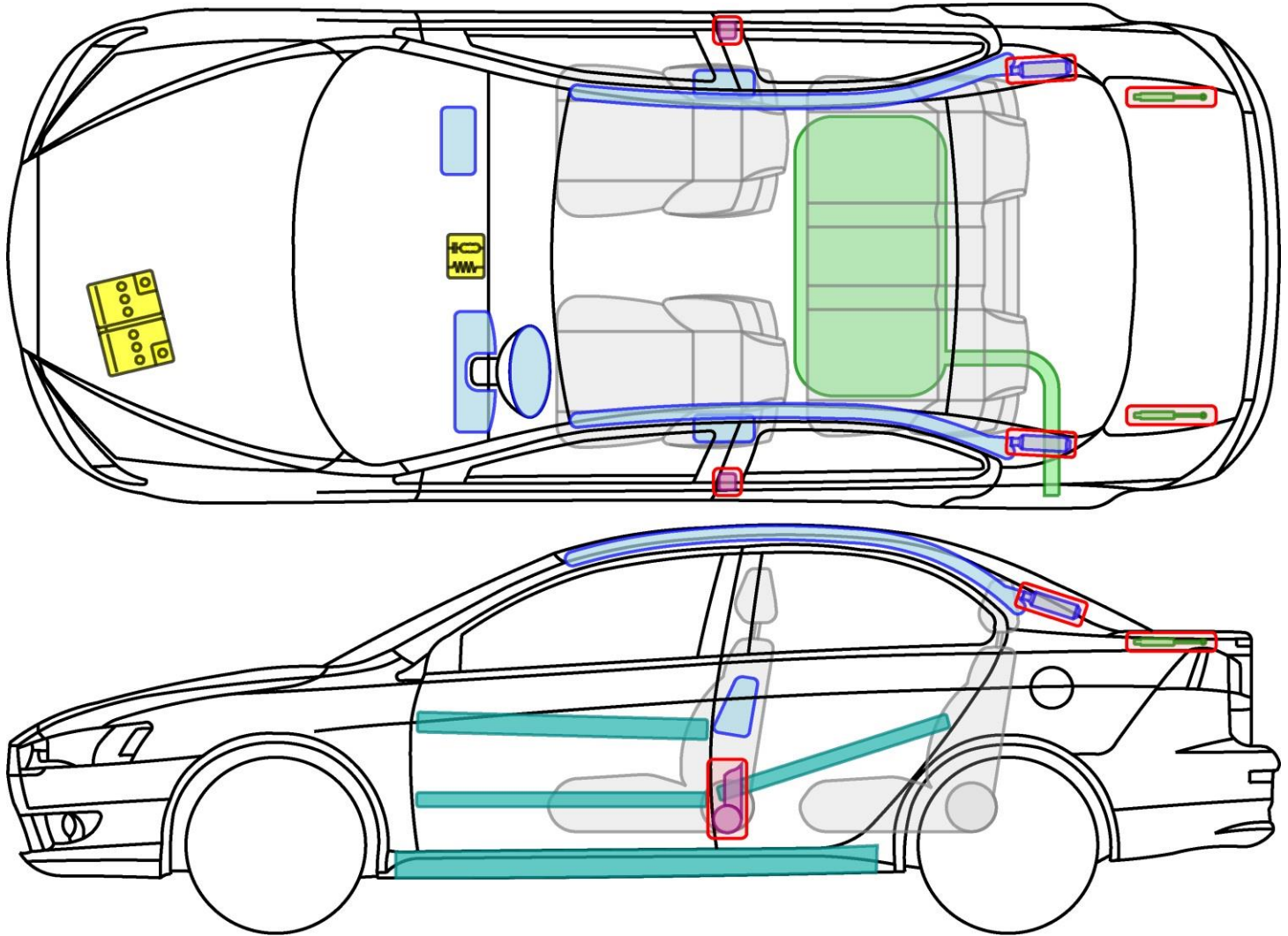

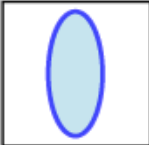

Legende

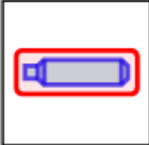
	Airbag		Karosserie- verstärkung		Steuergerät
	Gas- generator		Überroll- schutz		Batterie
	Gurt- straffer		Gasdruck- dämpfer		Kraftstoff- tank







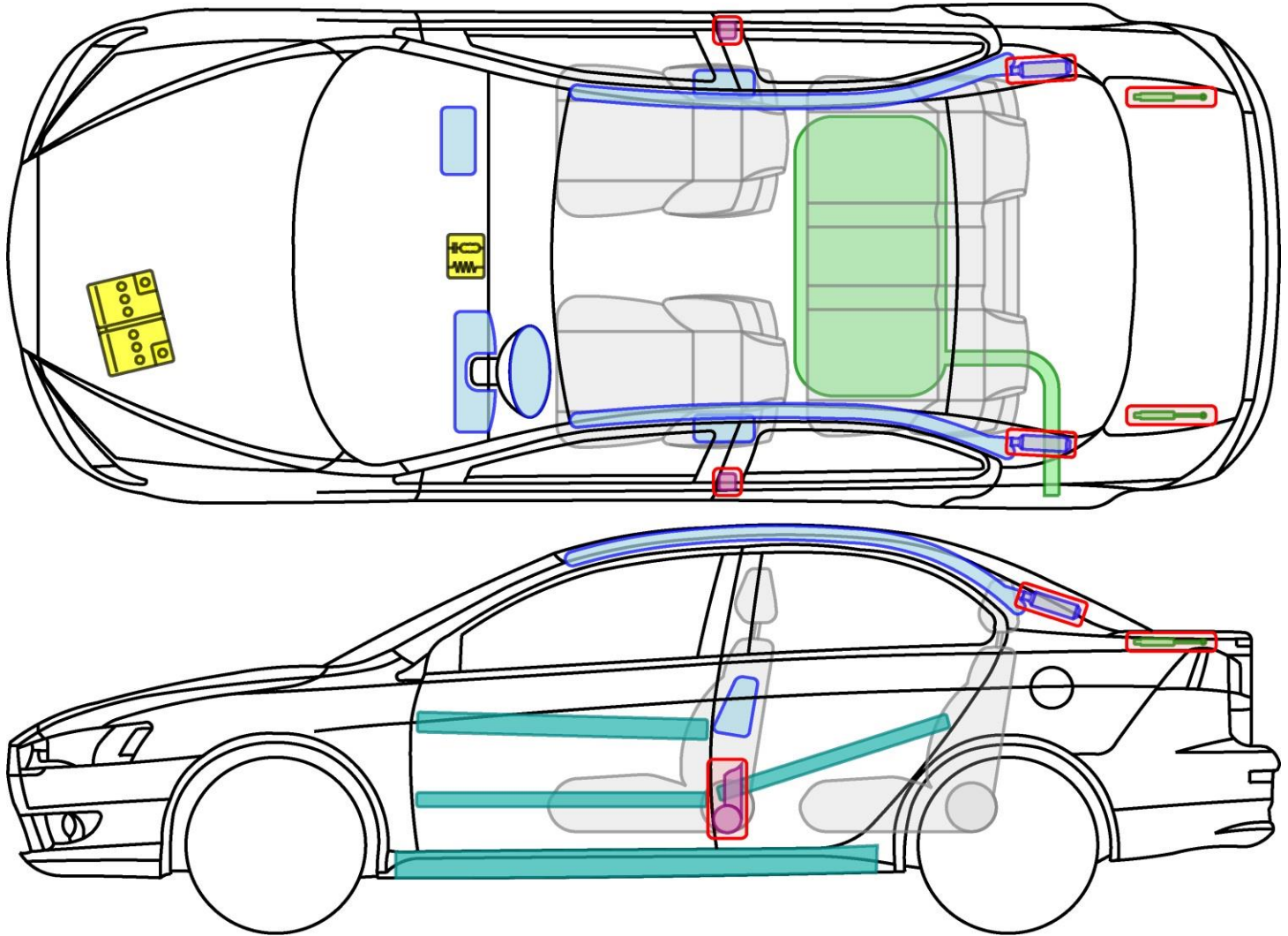

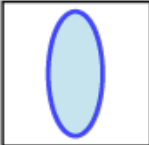

Legende

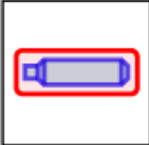
	Airbag		Karosserie- verstärkung		Steuergerät
	Gas- generator		Überroll- schutz		Batterie
	Gurt- straffer		Gasdruck- dämpfer		Kraftstoff- tank







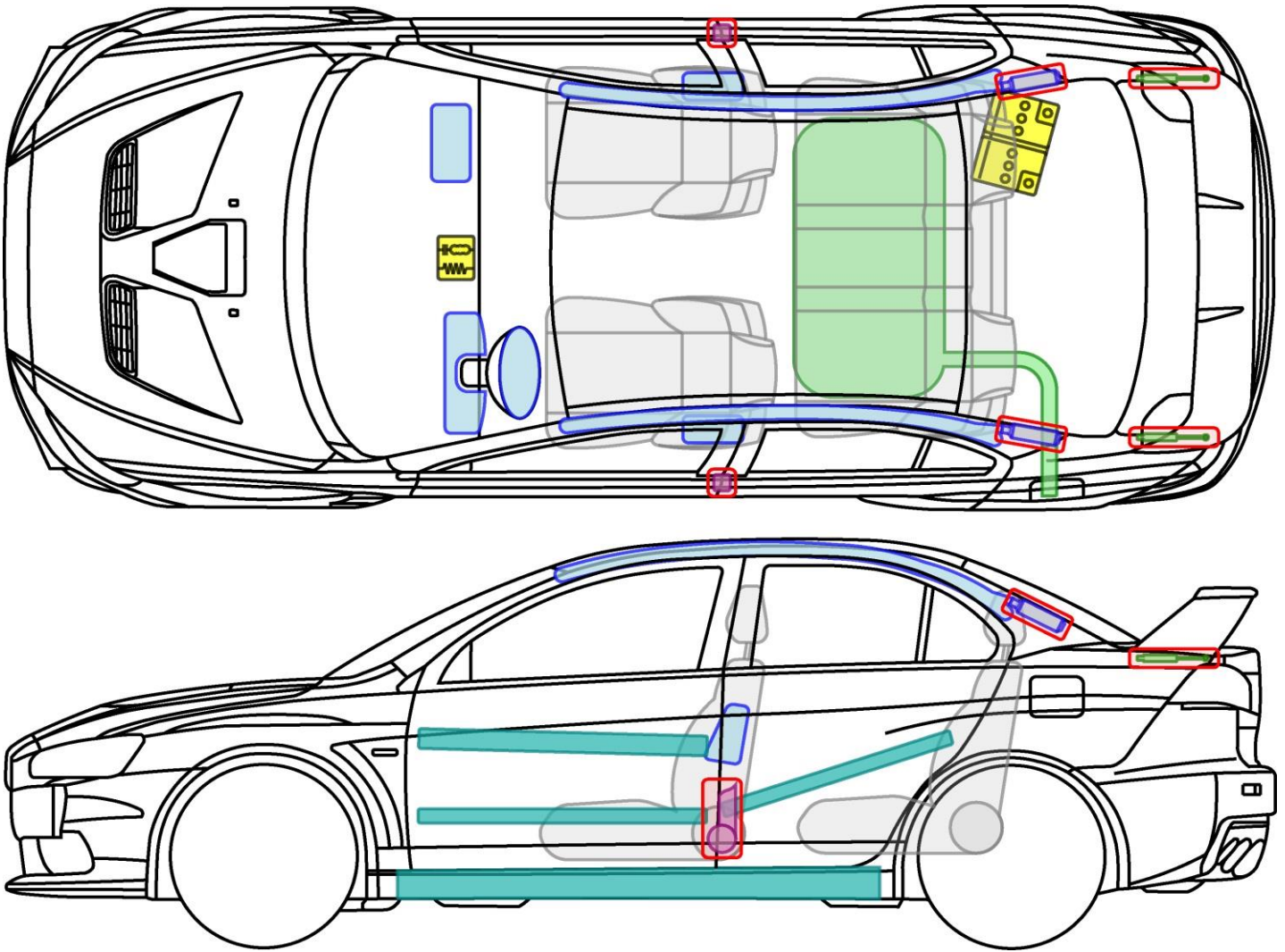

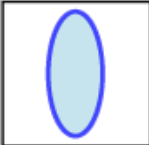

Legende

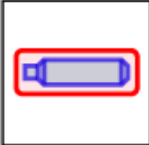
	Airbag		Karosserie- verstärkung		Steuergerät
	Gas- generator		Überroll- schutz		Batterie
	Gurt- straffer		Gasdruck- dämpfer		Kraftstoff- tank







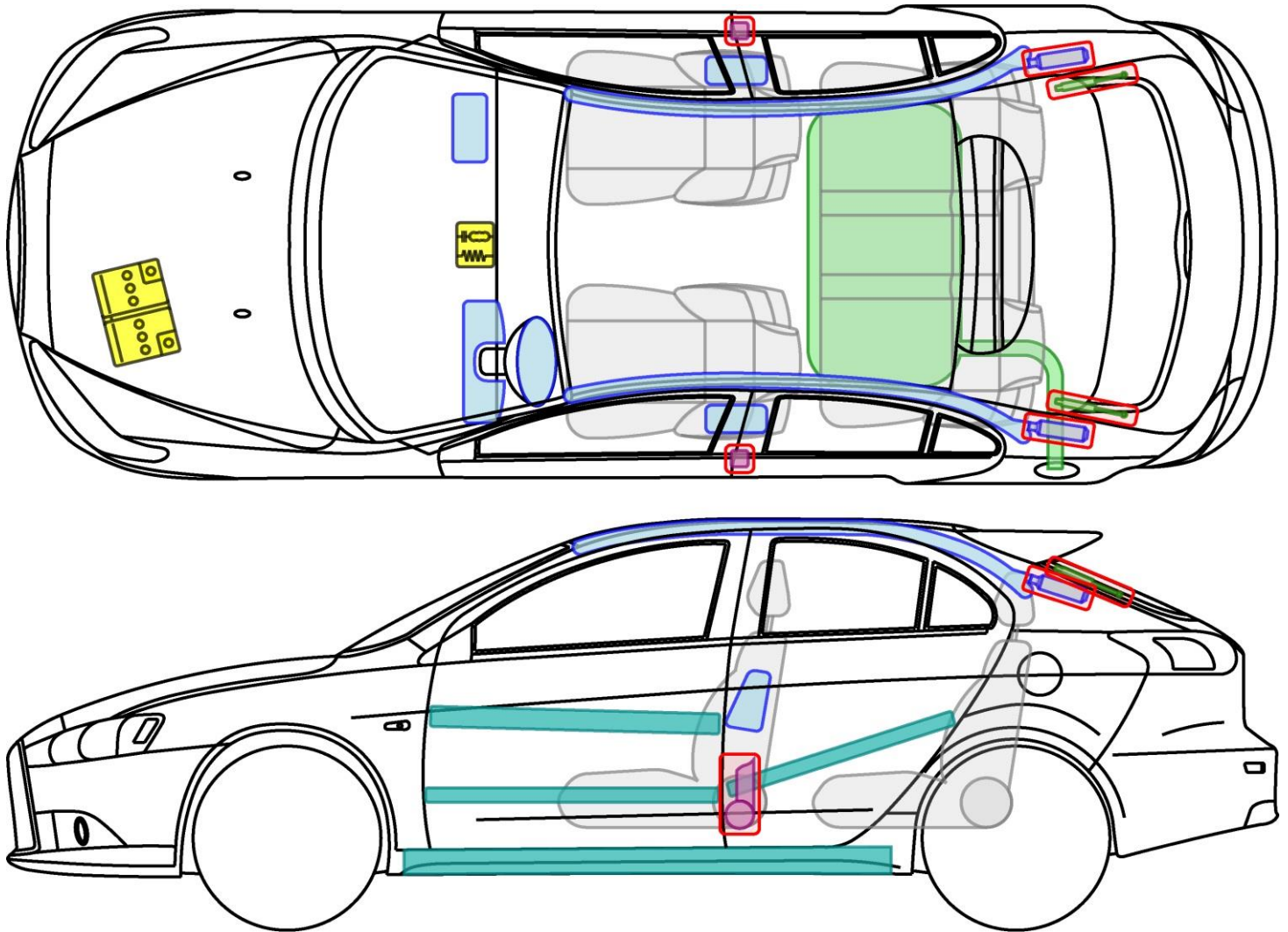



Legende

	Airbag		Karosserie- verstärkung		Steuergerät
	Gas- generator		Überroll- schutz		Batterie
	Gurt- straffer		Gasdruck- dämpfer		Kraftstoff- tank







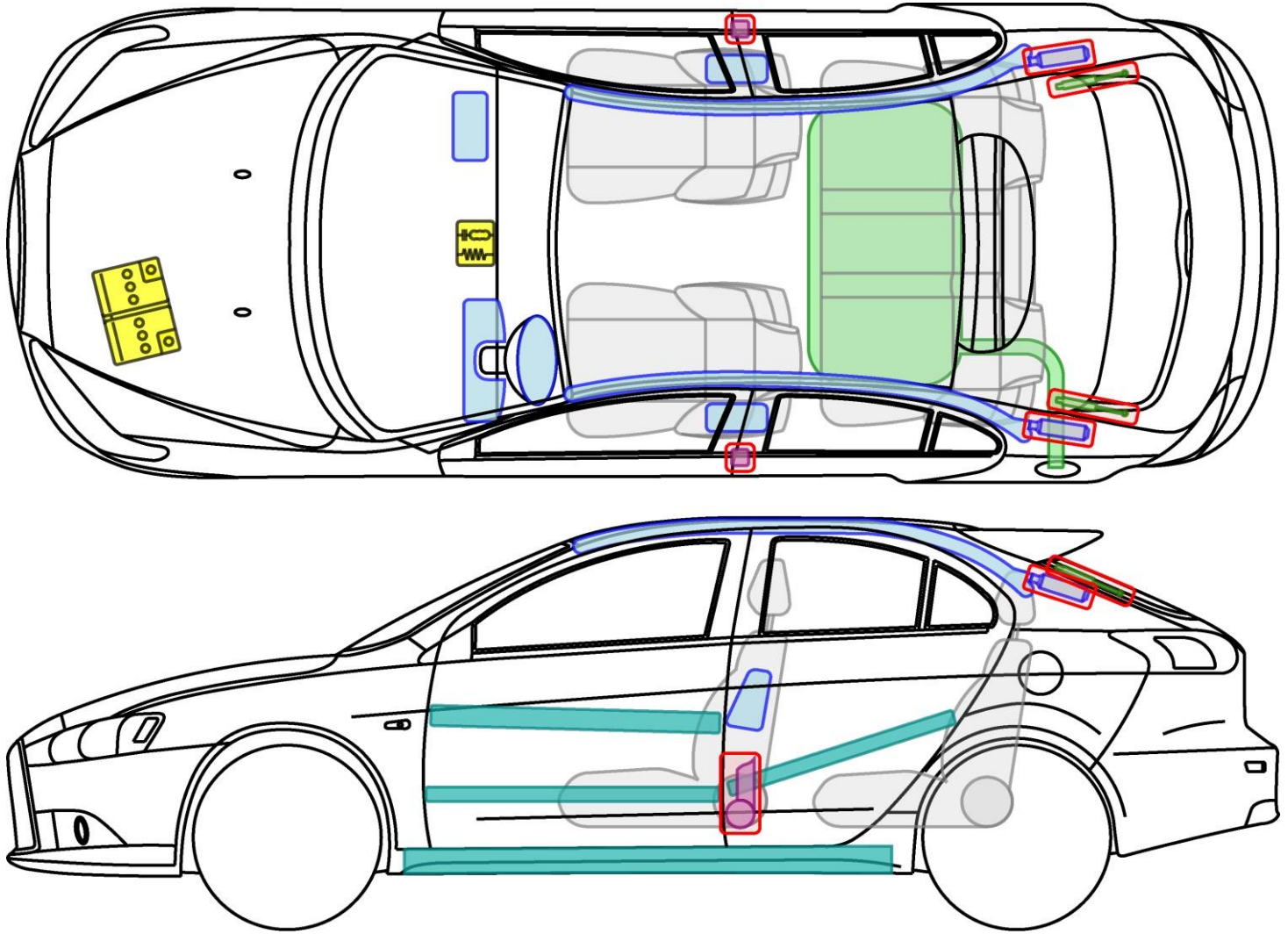



Legende

	Airbag		Karosserie- verstärkung		Steuergerät
	Gas- generator		Überroll- schutz		Batterie
	Gurt- straffer		Gasdruck- dämpfer		Kraftstoff- tank







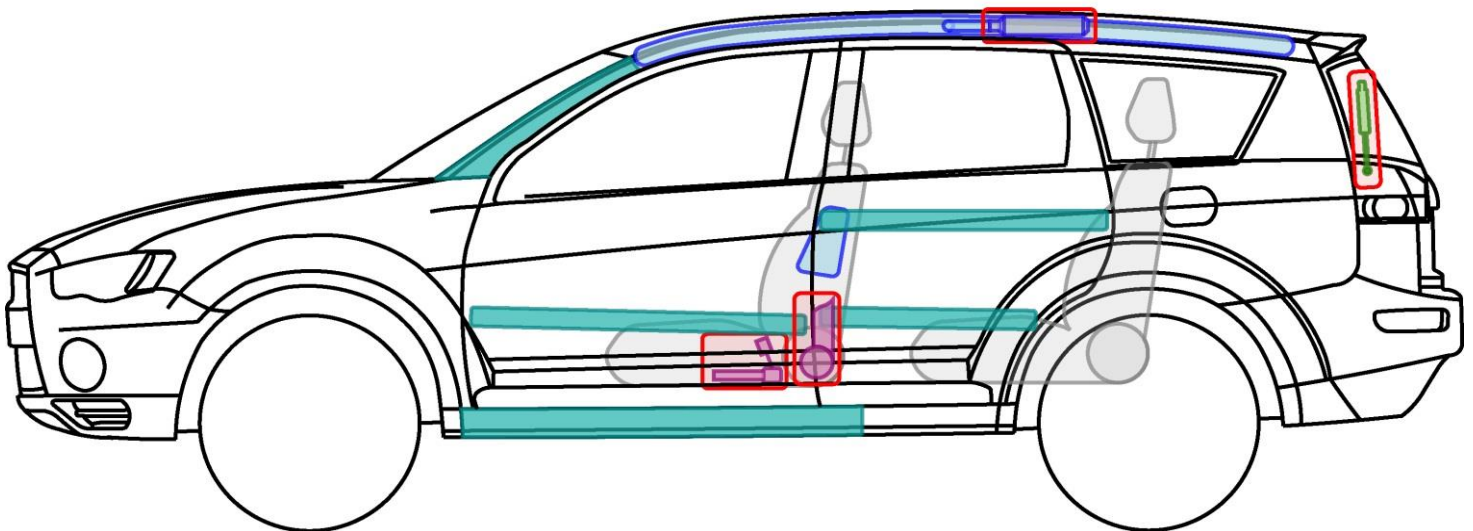
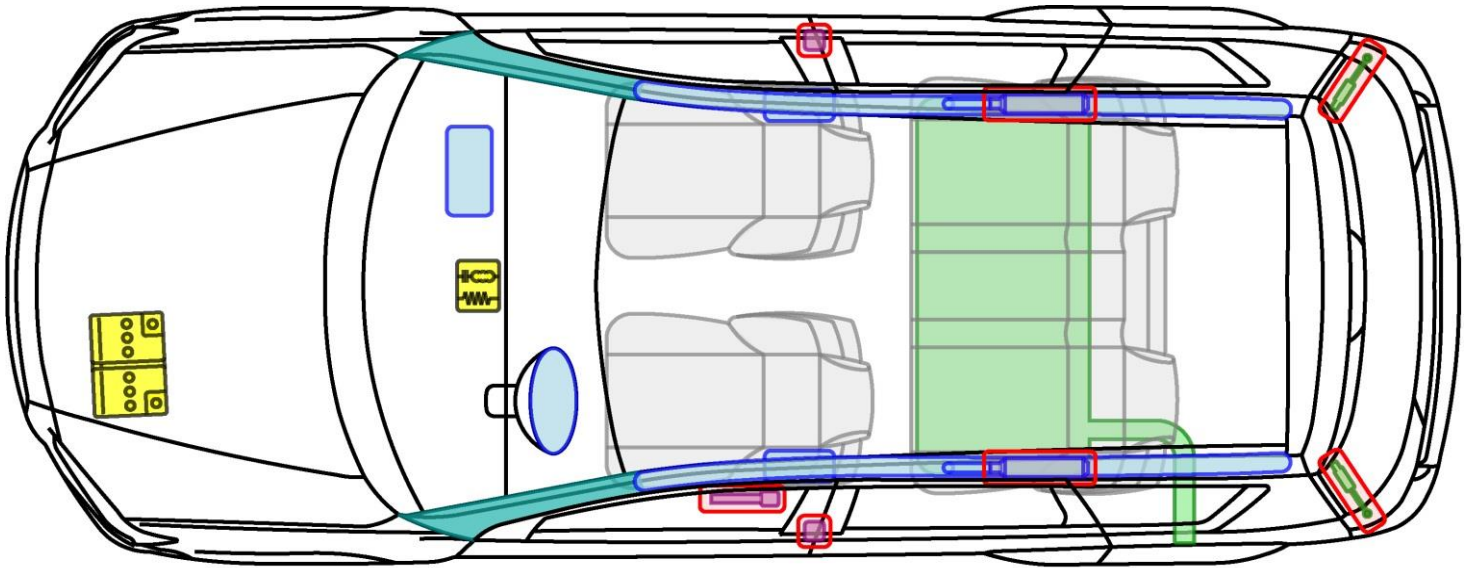

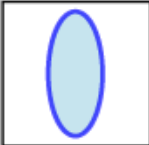

Legende

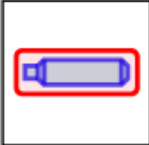
	Airbag		Karosserie- verstärkung		Steuergerät
	Gas- generator		Überroll- schutz		Batterie
	Gurt- straffer		Gasdruck- dämpfer		Kraftstoff- tank







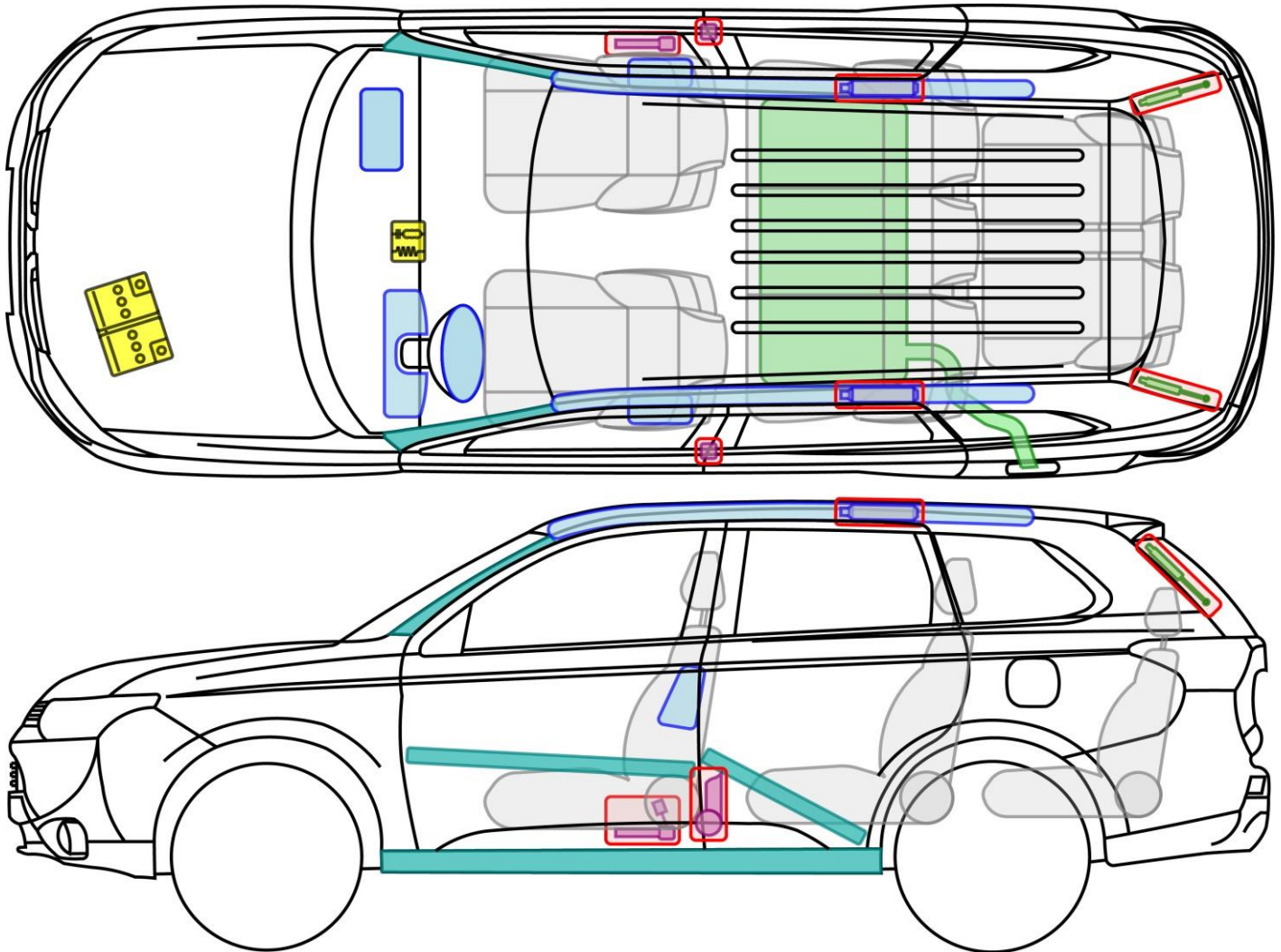



Legende

	Airbag		Karosserie- verstärkung		Steuergerät
	Gas- generator		Überroll- schutz		Batterie
	Gurt- straffer		Gasdruck- dämpfer		Kraftstoff- tank







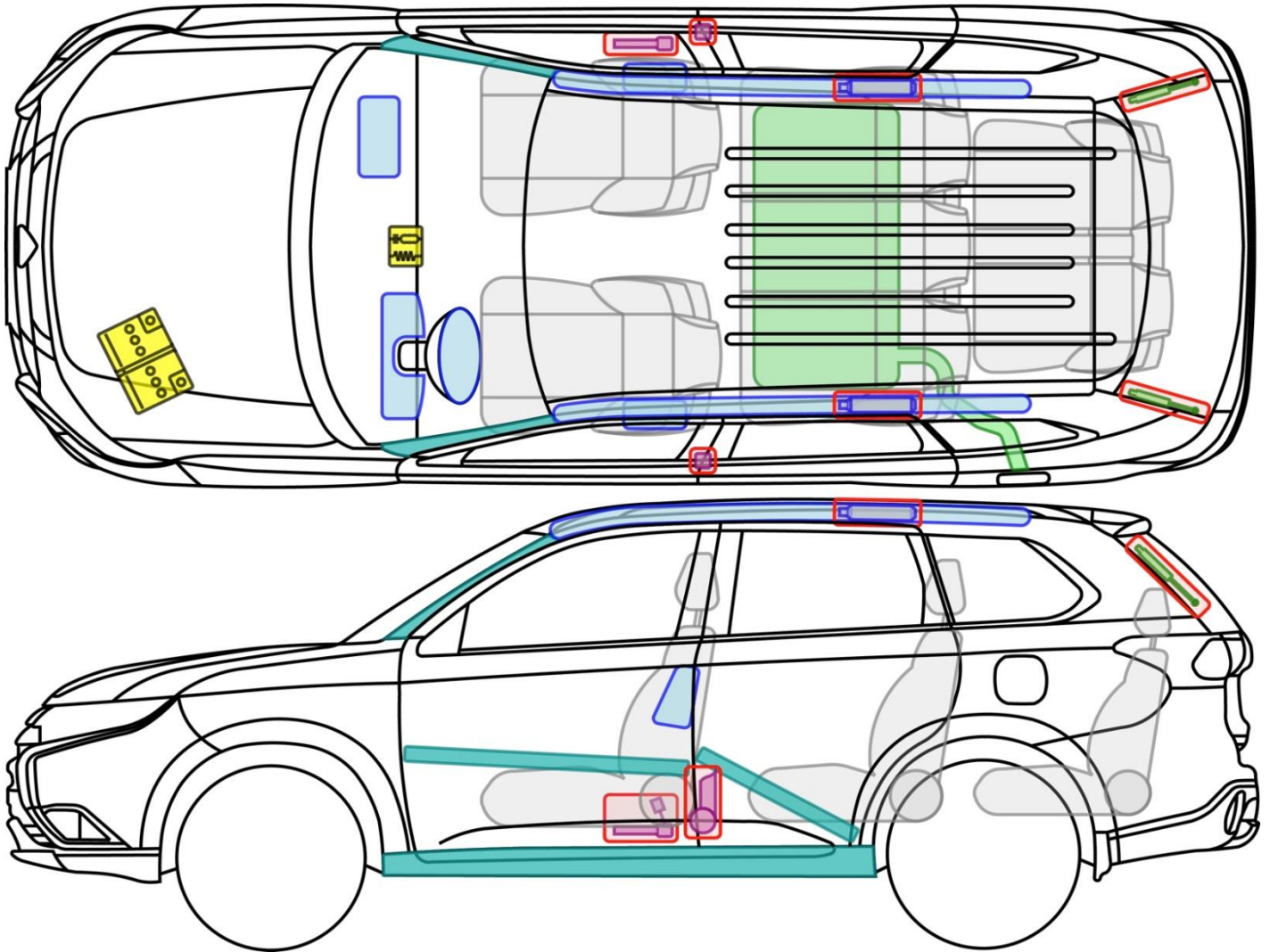

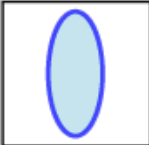

Legende

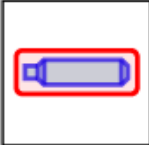
	Airbag		Karosserie- verstärkung		Steuergerät
	Gas- generator		Überroll- schutz		Batterie
	Gurt- straffer		Gasdruck- dämpfer		Kraftstoff- tank







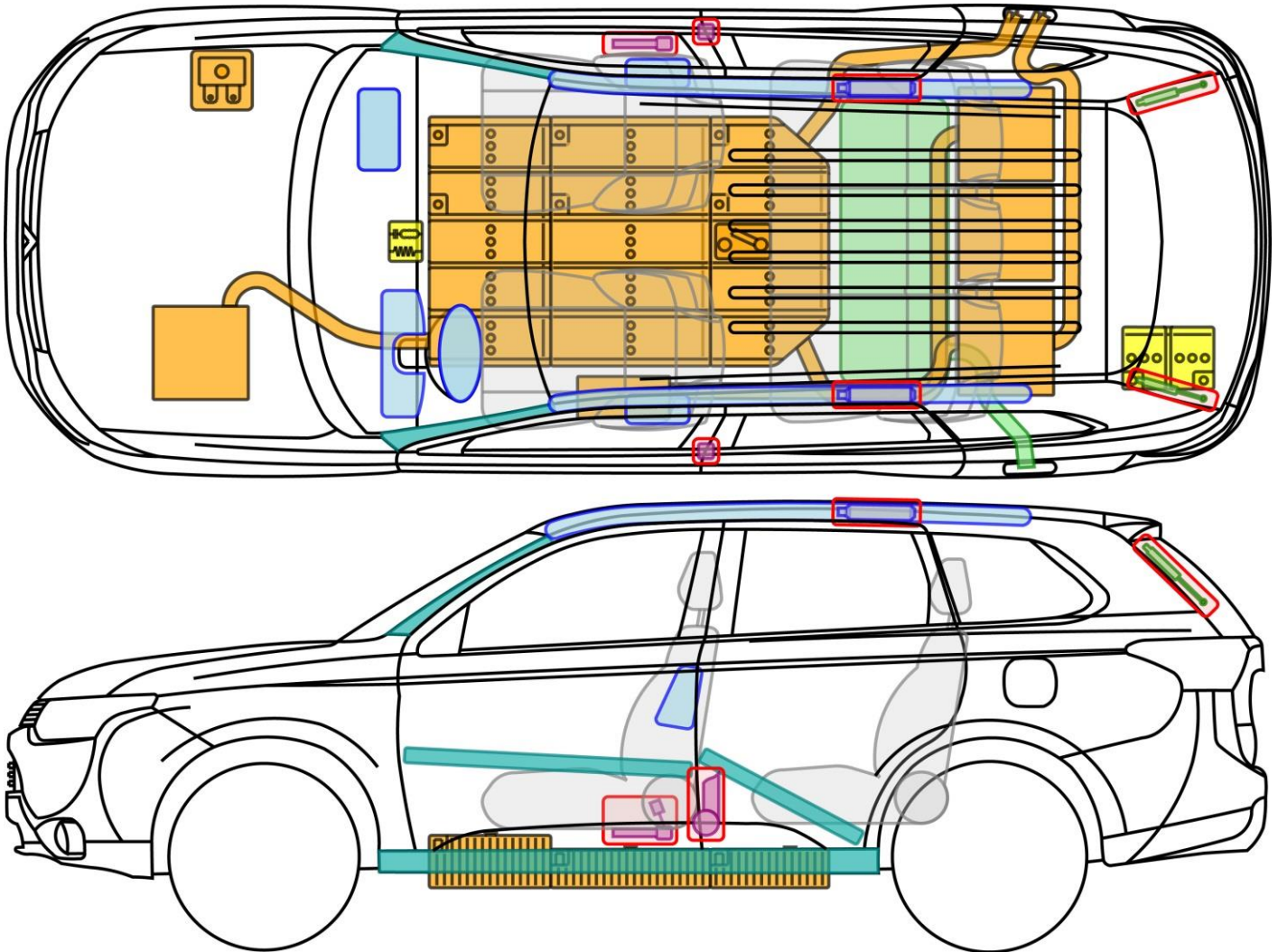



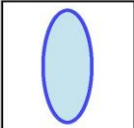

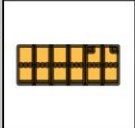
Legende

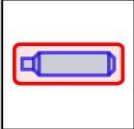
	Airbag		Karosserie- verstärkung		Steuergerät
	Gas- generator		Überroll- schutz		Batterie
	Gurt- straffer		Gasdruck- dämpfer		Kraftstoff- tank

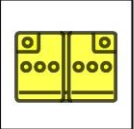

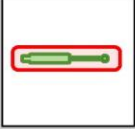
Legende

	Airbag		Karosserie- verstärkung		Steuergerät		Hochvolt- batterie		Hochvolt- Trennstelle
	Gas- generator		Überroll- schutz		12 V Batterie		Hochvolt- leitung/ -komponente		
	Gurt- straffer		Gasdruck- dämpfer		Kraftstoff- tank		Sicherungs- kasten		



Allgemeine Hinweise

- Bei Unfällen mit Airbag und/oder Gurtstrafferauslösung wird der Fahrzeugantrieb automatisch deaktiviert. Die Rückhaltesysteme sind weiterhin aktiv.
- Hochvoltkomponenten im Fahrzeug sind mit eindeutigen Warnaufklebern gekennzeichnet. Hochvoltkabel verfügen über eine orangefarbene Isolierung.
- Die Deaktivierungszeit bis zur vollständigen Deaktivierung der Rückhaltesysteme (Airbag, Gurtstraffer) beträgt **1 Minute** nach Durchführung der Deaktivierungsschritte.
- Die Deaktivierungszeit bis zur vollständigen Deaktivierung des Antriebs beträgt **10 Minuten** nach Durchführung der Deaktivierungsschritte.
- Vor Beginn von Arbeiten am Fahrzeug Ladestecker ziehen!

Fahrzeug gegen wegrollen sichern

- Gangwahlhebel in Stellung „P“ bringen.
- Feststellbremse betätigen.

Antrieb/Rückhaltesysteme deaktivieren

Methode 1 (Startknopf zugänglich)

1. Status des Antriebs prüfen. Leuchtet die „READY“-Leuchte Startknopf einmal betätigen.
2. 12 Volt Batterie abklemmen

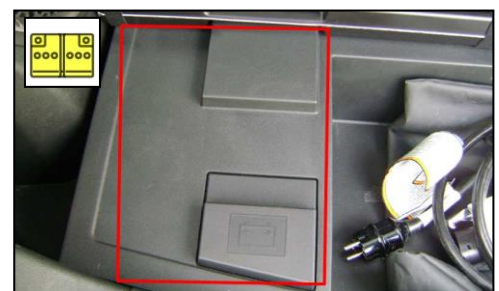



Antrieb/Rückhaltesysteme deaktivieren

Methode 2 (Startknopf nicht zugänglich)

1. Sicherungskasten lokalisieren



2. „Power Unit Control“-Sicherung entfernen (Nr. F7, 10 A)

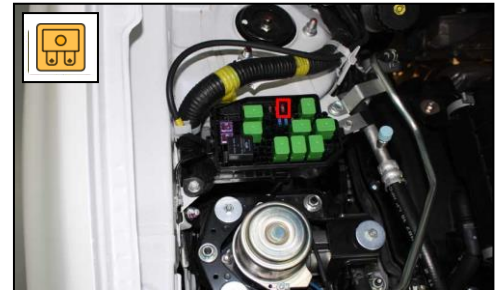

3. 12 Volt Batterie abklemmen

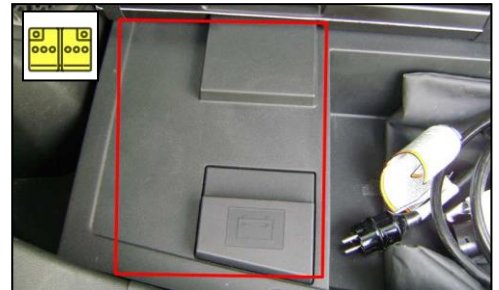



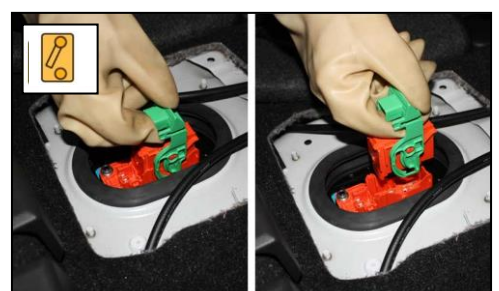
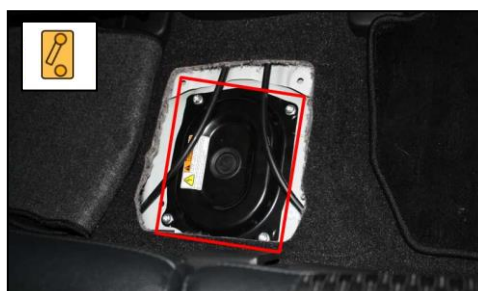
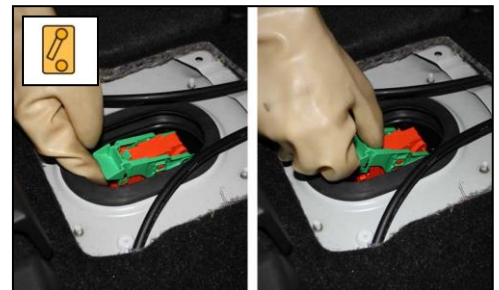

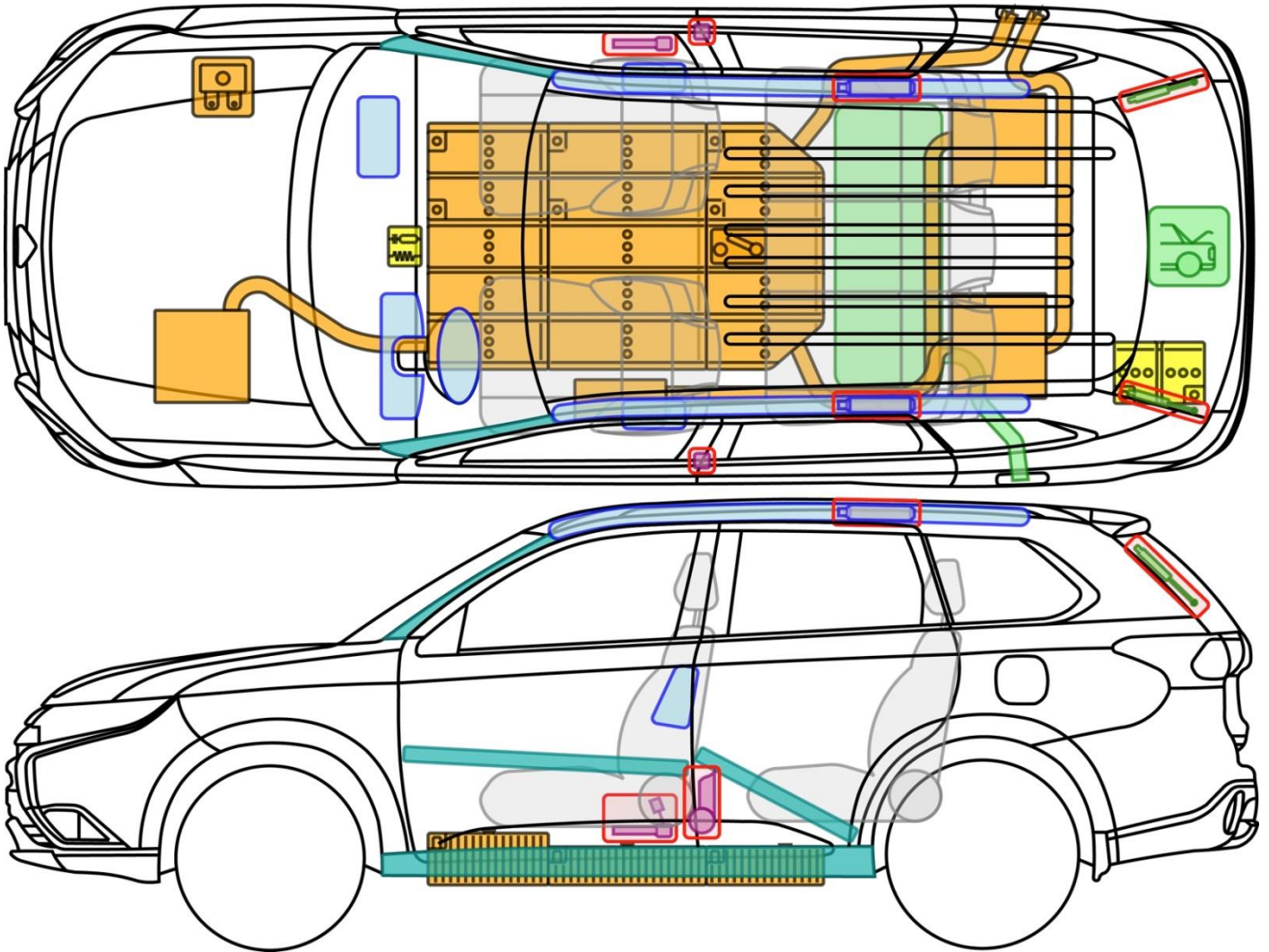



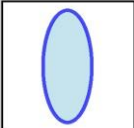

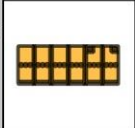
4. Wartungsstecker entfernen
(isolierende Handschuhe bis 1000 V erforderlich).

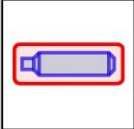

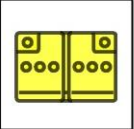

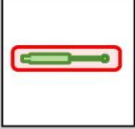
Legende

	Airbag		Karosserie- verstärkung		Steuergerät		Hochvolt- batterie		Hochvolt- Trennstelle
	Gas- generator		Überroll- schutz		12 V Batterie		Hochvolt- leitung/ -komponente		
	Gurt- straffer		Gasdruck- dämpfer		Kraftstoff- tank		Sicherungs- kasten		



Allgemeine Hinweise

- Bei Unfällen mit Airbag und/oder Gurtstrafferauslösung wird der Fahrzeugantrieb automatisch deaktiviert. Die Rückhaltesysteme sind weiterhin aktiv.
- Hochvoltkomponenten im Fahrzeug sind mit eindeutigen Warnaufklebern gekennzeichnet. Hochvoltkabel verfügen über eine orangefarbene Isolierung.
- Die Deaktivierungszeit bis zur vollständigen Deaktivierung der Rückhaltesysteme (Airbag, Gurtstraffer) beträgt **1 Minute** nach Durchführung der Deaktivierungsschritte.
- Die Deaktivierungszeit bis zur vollständigen Deaktivierung des Antriebs beträgt **10 Minuten** nach Durchführung der Deaktivierungsschritte.
- Vor Beginn von Arbeiten am Fahrzeug Ladestecker ziehen!

Fahrzeug gegen wegrollen sichern

- Gangwahlhebel in Stellung „P“ bringen.
- Feststellbremse betätigen.

Antrieb/Rückhaltesysteme deaktivieren

Methode 1 (Startknopf zugänglich)

1. Status des Antriebs prüfen. Leuchtet die „READY“-Leuchte Startknopf einmal betätigen.
2. 12 Volt Batterie abklemmen

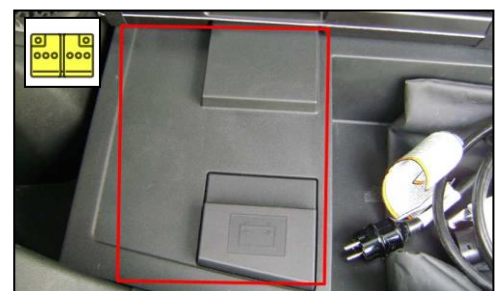



Antrieb/Rückhaltesysteme deaktivieren





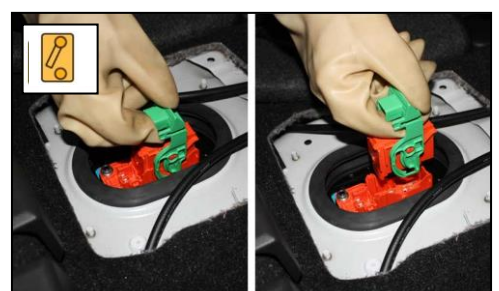
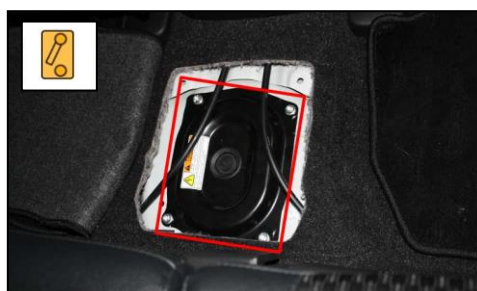
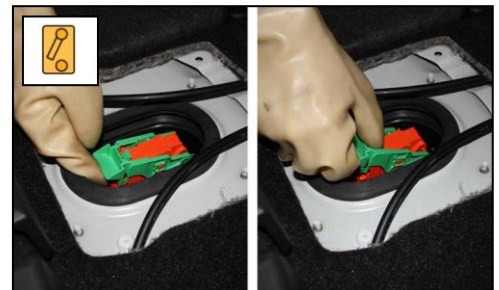
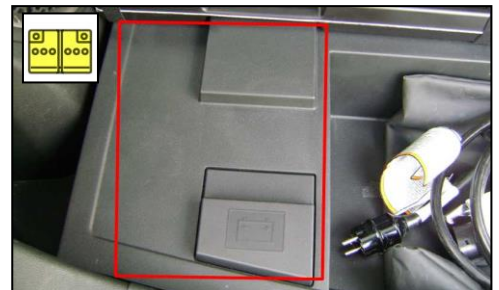
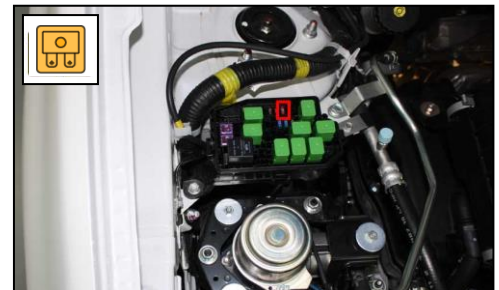

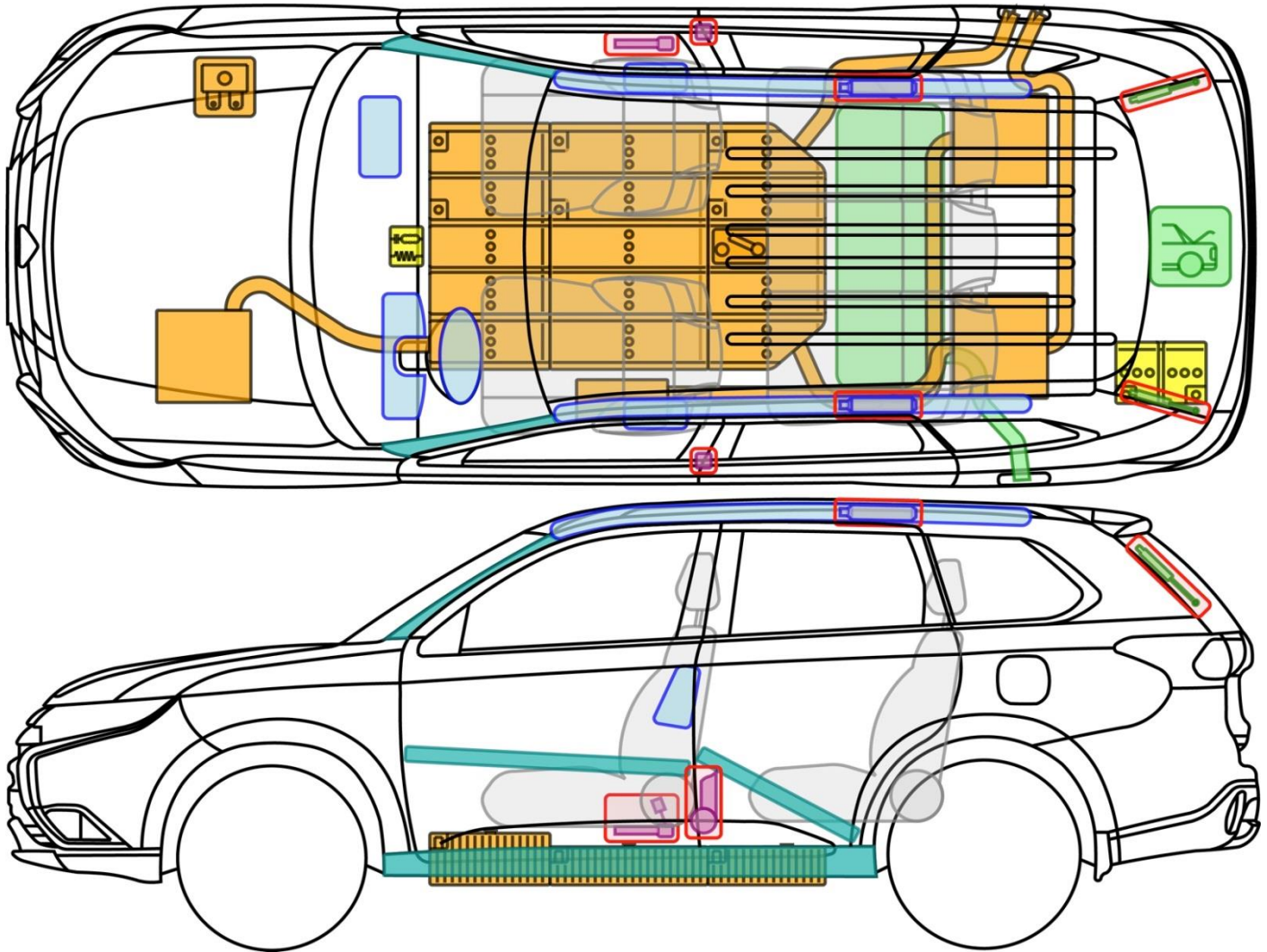

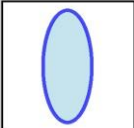

Methode 2 (Startknopf nicht zugänglich)

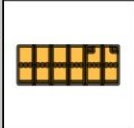
1. Sicherungskasten lokalisieren
2. „Power Unit Control“-Sicherung entfernen (Nr. F7, 10 A)
3. 12 Volt Batterie abklemmen
4. Wartungsstecker entfernen
(isolierende Handschuhe bis 1000 V erforderlich).

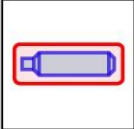

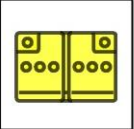

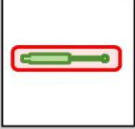
Legende

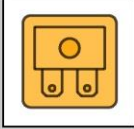
	Airbag		Karosserie- verstärkung		Steuergerät		Hochvolt- batterie		Hochvolt- Trennstelle
	Gas- generator		Überroll- schutz		12 V Batterie		Hochvolt -leitung/ -komponente		
	Gurt- straffer		Gasdruck- dämpfer		Kraftstoff- tank		Sicherungs- kasten		



Allgemeine Hinweise

- Bei Unfällen mit Airbag und/oder Gurtstrafferauslösung wird der Fahrzeugantrieb automatisch deaktiviert. Die Rückhaltesysteme sind weiterhin aktiv.
- Hochvoltkomponenten im Fahrzeug sind mit eindeutigen Warnaufklebern gekennzeichnet. Hochvoltkabel verfügen über eine orangefarbene Isolierung.
- Die Deaktivierungszeit bis zur vollständigen Deaktivierung der Rückhaltesysteme (Airbag, Gurtstraffer) beträgt **1 Minute** nach Durchführung der Deaktivierungsschritte.
- Die Deaktivierungszeit bis zur vollständigen Deaktivierung des Antriebs beträgt **10 Minuten** nach Durchführung der Deaktivierungsschritte.
- Vor Beginn von Arbeiten am Fahrzeug Ladestecker ziehen!

Fahrzeug gegen wegrollen sichern

- Gangwahlhebel in Stellung „P“ bringen.
- Feststellbremse betätigen.

Antrieb/Rückhaltesysteme deaktivieren

Methode 1 (Startknopf zugänglich)

1. Status des Antriebs prüfen. Leuchtet die „READY“-Leuchte Startknopf einmal betätigen.
2. 12 Volt Batterie abklemmen

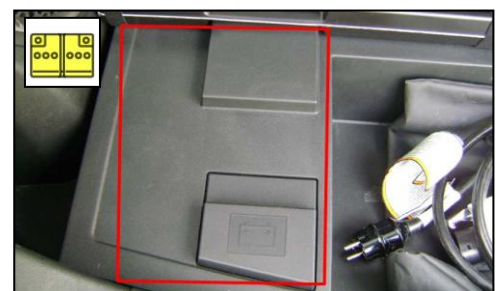



Antrieb/Rückhaltesysteme deaktivieren





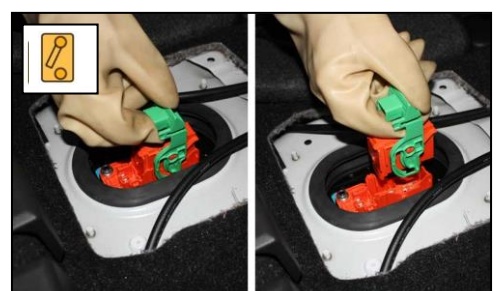
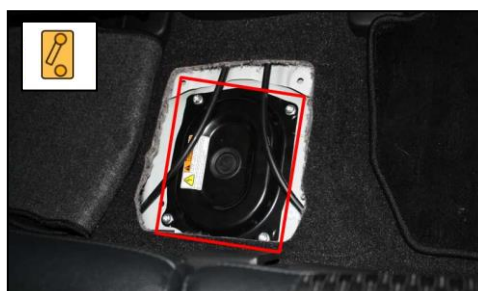
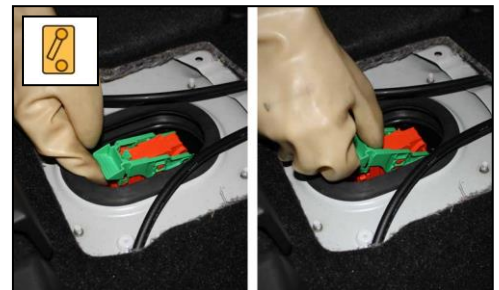
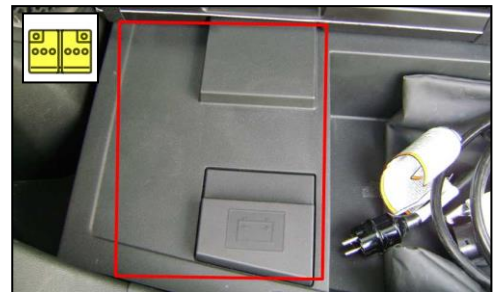
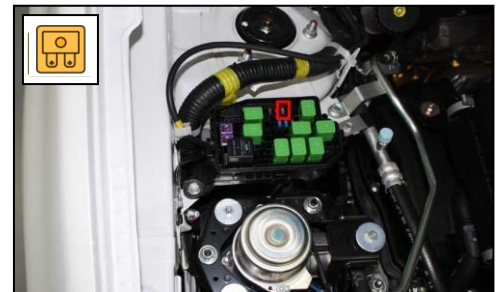

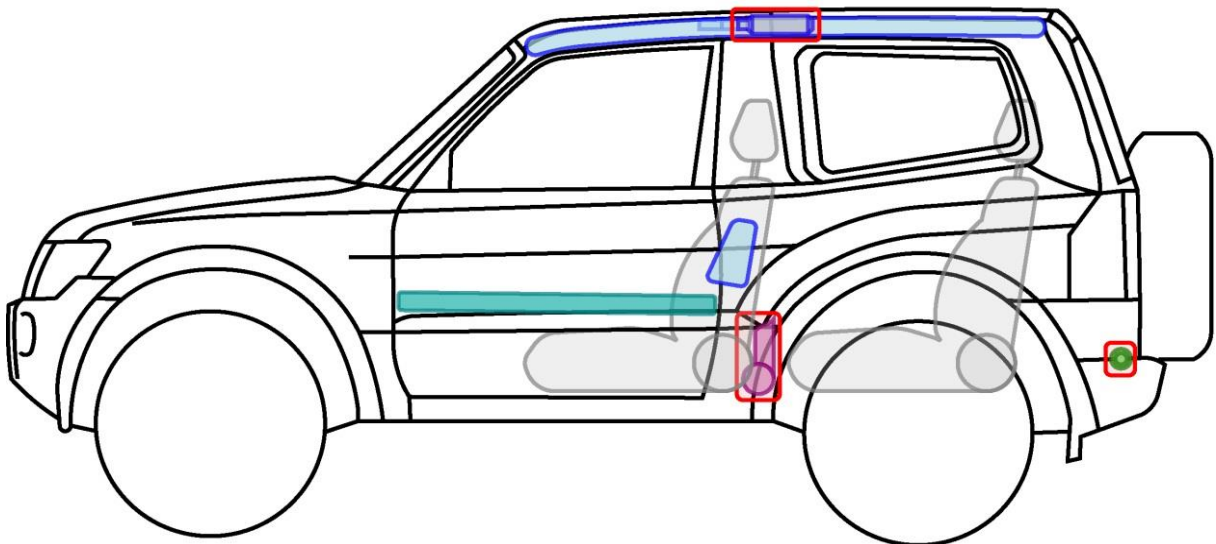
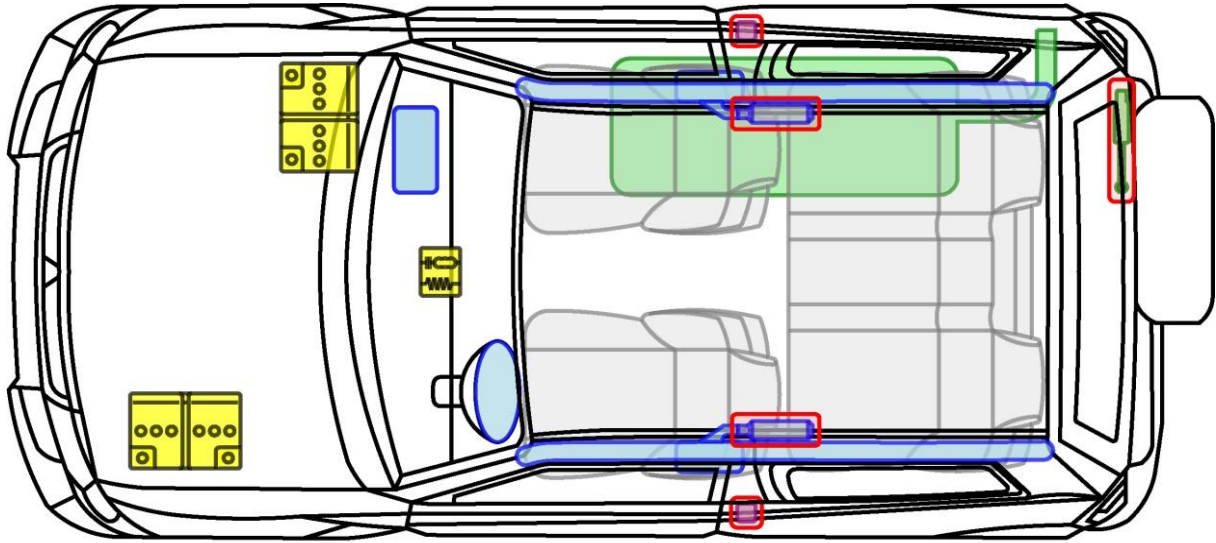

Methode 2 (Startknopf nicht zugänglich)

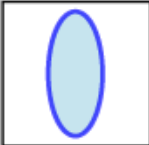
1. Sicherungskasten lokalisieren
2. „Power Unit Control“-Sicherung entfernen (Nr. F7, 10 A)
3. 12 Volt Batterie abklemmen
4. Wartungsstecker entfernen
(isolierende Handschuhe bis 1000 V erforderlich).

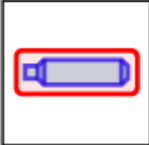







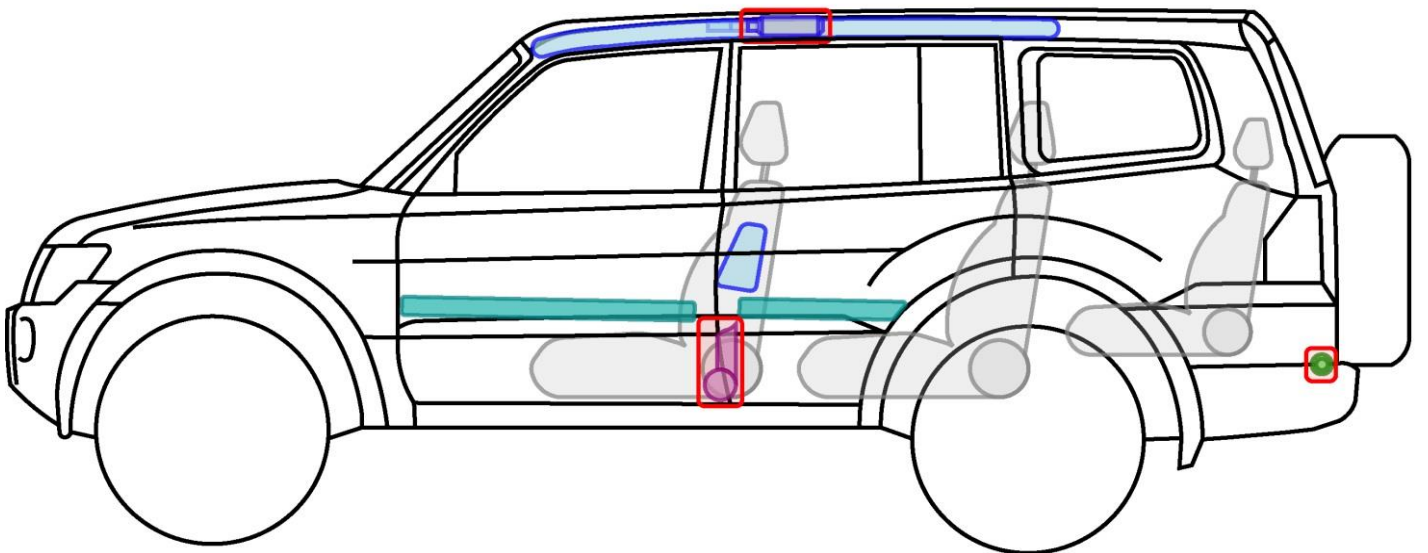
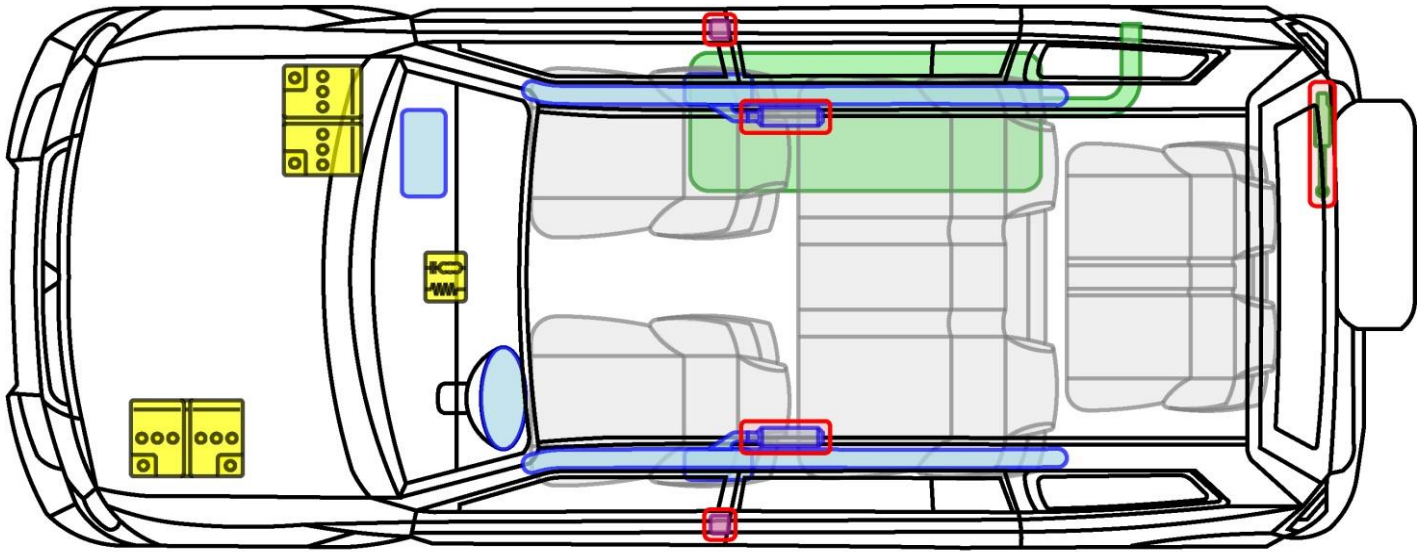

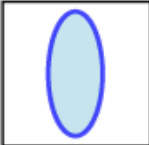

Legende

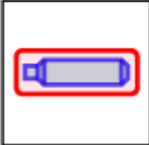
	Airbag		Karosserie- verstärkung		Steuergerät
	Gas- generator		Überroll- schutz		Batterie
	Gurt- straffer		Gasdruck- dämpfer		Kraftstoff- tank







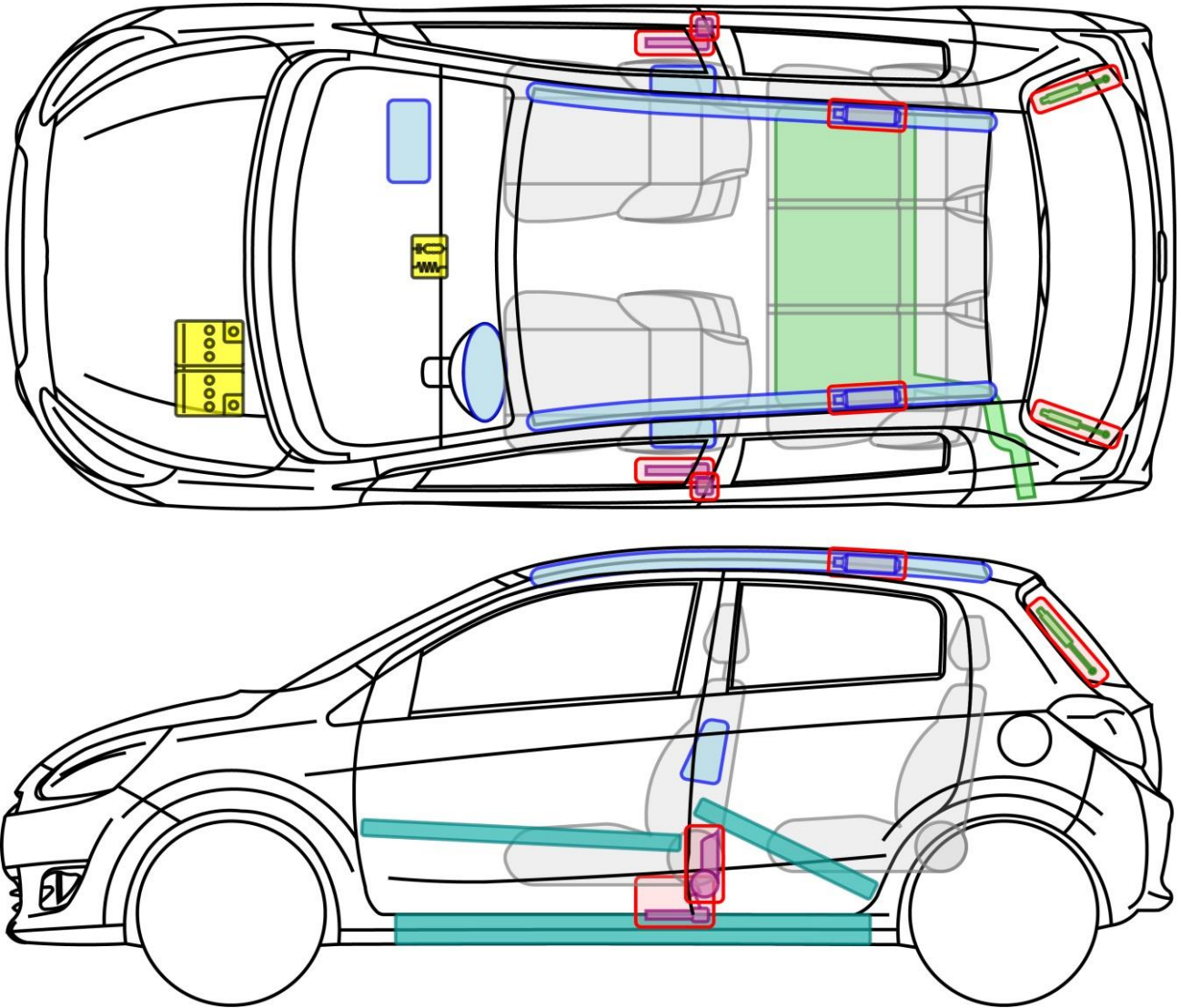

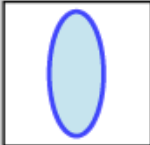

Legende

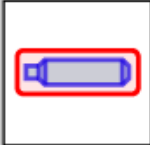
	Airbag		Karosserie- verstärkung		Steuergerät
	Gas- generator		Überroll- schutz		Batterie
	Gurt- straffer		Gasdruck- dämpfer		Kraftstoff- tank







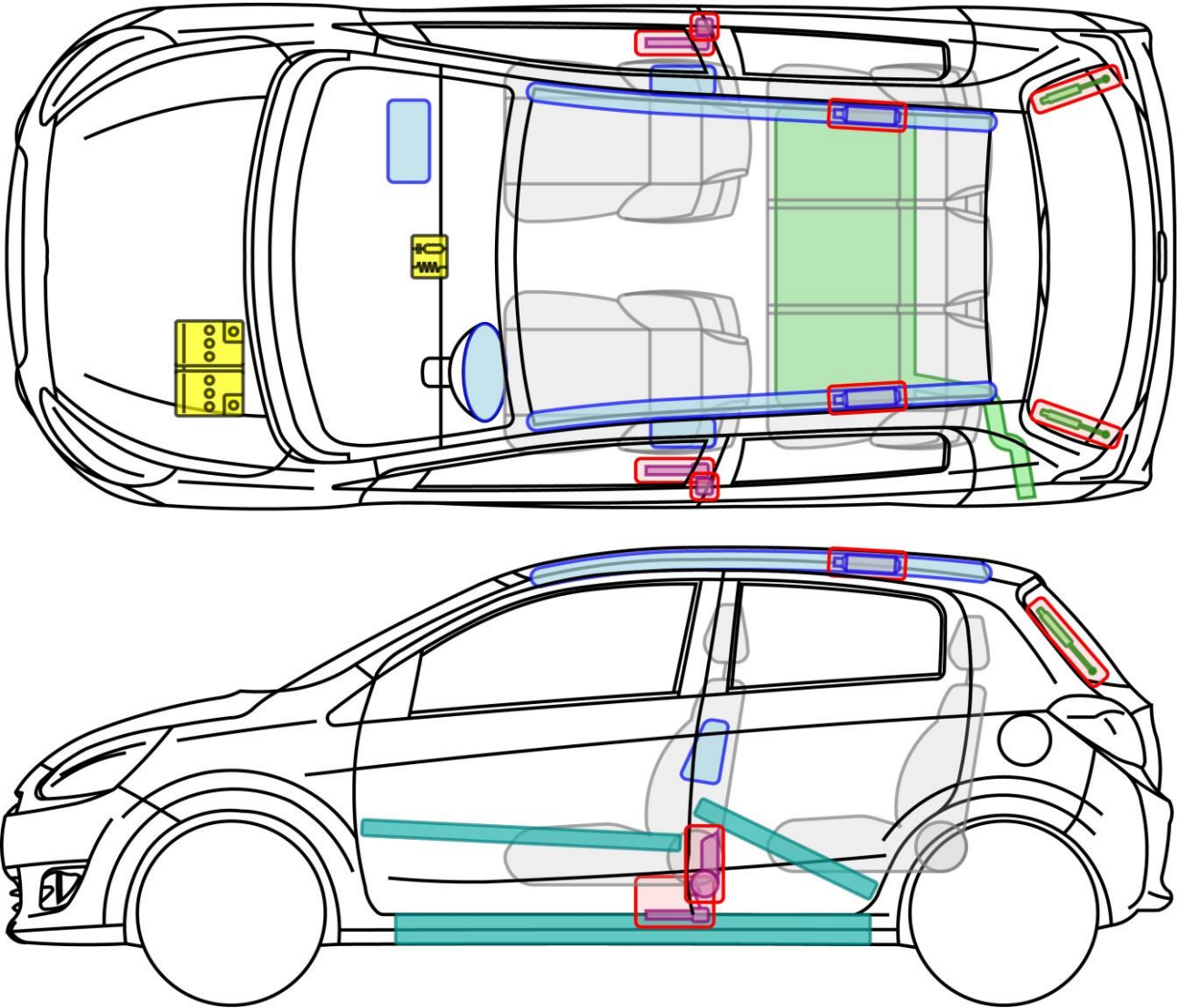

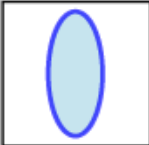

Legende

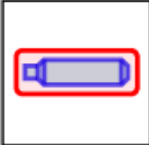
	Airbag		Karosserie- verstärkung		Steuergerät
	Gas- generator		Überroll- schutz		Batterie
	Gurt- straffer		Gasdruck- dämpfer		Kraftstoff- tank







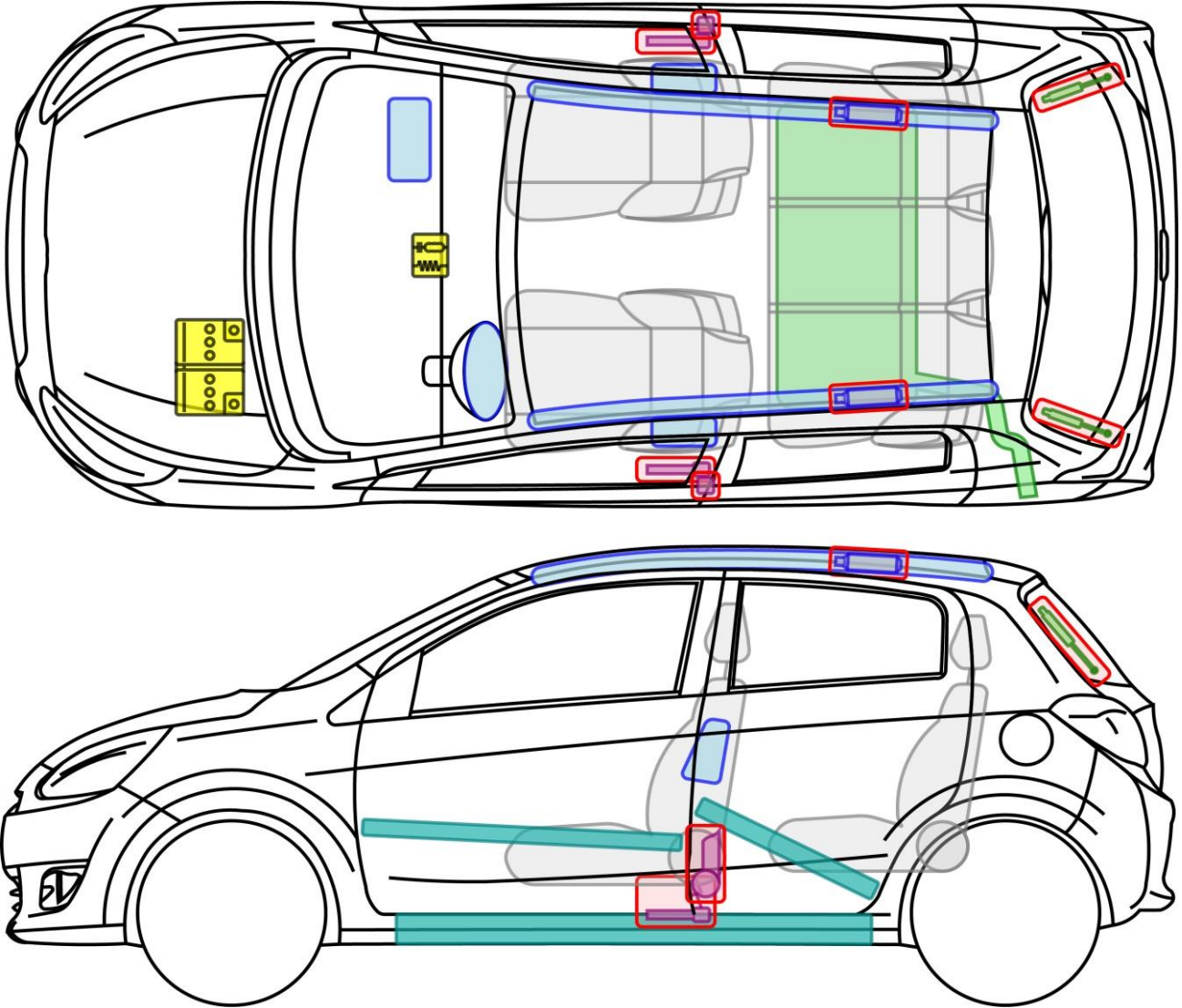

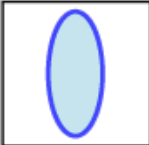

Legende

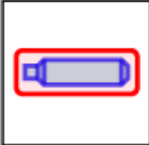
	Airbag		Karosserie- verstärkung		Steuergerät
	Gas- generator		Überroll- schutz		Batterie
	Gurt- straffer		Gasdruck- dämpfer		Kraftstoff- tank



Legende

	Airbag		Karosserie- verstärkung		Steuergerät
	Gas- generator		Überroll- schutz		Batterie
	Gurt- straffer		Gasdruck- dämpfer		Kraftstoff- tank