



**MITSUBISHI
MOTORS**

Drive your Ambition

PAJERO



Effortlessly Elegant, Powerfully Rugged

Nothing says power and prestige like Mitsubishi's internationally acclaimed Pajero. Sleek yet rugged, this exclusive, all-around SUV is ready to take on any environment, from crowded city streets and bumpy back roads to unpaved paths just waiting to be explored. With premium features, exhilarating performance, and style that just won't quit, you'll only wish you'd discovered it sooner.



3.8-liter 5-Door GLS shown with optional equipment / Sterling Silver Metallic [U25]
Equipment may vary by market. Please consult your local Mitsubishi Motors dealer/distributor for details.

Note: Hazardous driving may cause serious injury or vehicle damage. Please drive safely all the time.



3.8-liter 5-Door GLS shown with optional equipment / Black Leather seats
Equipment may vary by market. Please consult your local Mitsubishi Motors dealer/distributor for details.

Man-Machine Interface

Comfortable and inviting, the interior of Pajero is a far cry from the terrain it was designed to face. Illuminated meters and leather-wrapped controls are all ergonomically arranged and awaiting your command, while the soft leather seats and luxurious appointments throughout tempt you to forget your destination and simply keep driving.





3.8-liter 5-Door GLS shown with optional equipment / Black Leather seats
Equipment may vary by market. Please consult your local Mitsubishi Motors dealer/distributor for details.

Cool Sport

As sleek as it is spacious, Pajero's expansive interior delivers a ride of luxurious comfort for you and your passengers. Providing ample head- and legroom for up to seven occupants, Pajero also features versatile seating arrangements to match your carrying needs. The third-row seats can be easily stowed under the floor to create a wide, flat storage space ideal for suitcases, or removed completely to give you a convenient underfloor compartment. For even larger items, the second-row seats can also be folded down to provide enough space for nearly anything you want to bring.



Flexible Utility Space (5-Door)

Every day brings new destinations, new friends, and new adventures. You don't want to be stuck in someone else's rigid assumptions of where to go and what to do. Pajero understands, and provides you an interior as versatile as it is roomy, with plenty of seating and storage options for work, fun or daily life.



Seat Arrangements

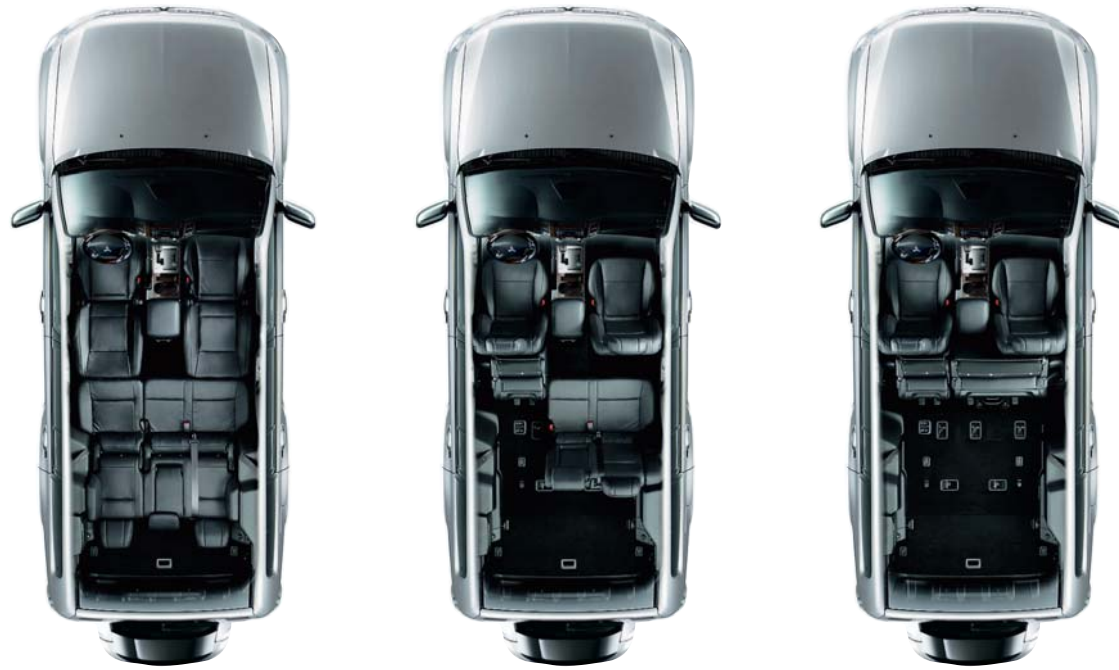

With the 3rd-row stowed, the 1st and 2nd-rows can be laid flat, creating a comfortable sleeping area.

The 2nd-row has a 60:40 split, allowing you to carry extra-long cargo while still seating four comfortably. (GLS only)

Fold up the 2nd-row as well to make full use of Pajero's massive carrying capacity.

Convenient Folding 2nd- and 3rd-row Seats

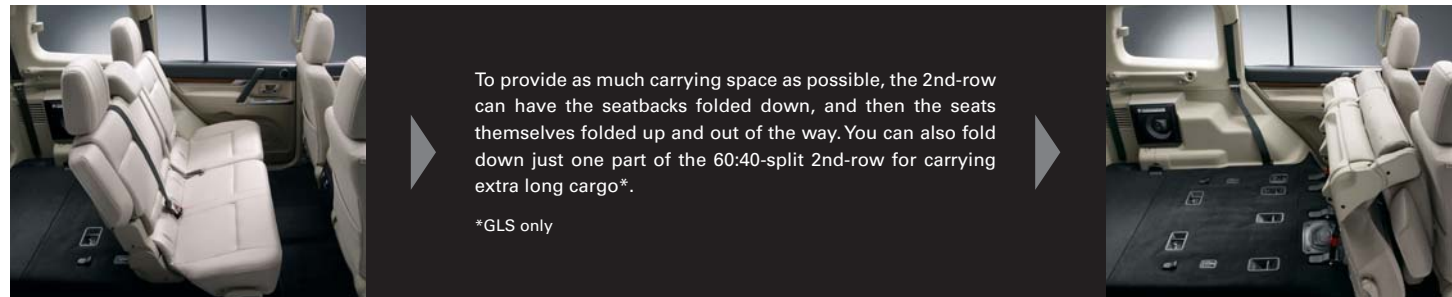

To provide as much carrying space as possible, the 2nd-row can have the seatbacks folded down, and then the seats themselves folded up and out of the way. You can also fold down just one part of the 60:40-split 2nd-row for carrying extra long cargo*.

*GLS only

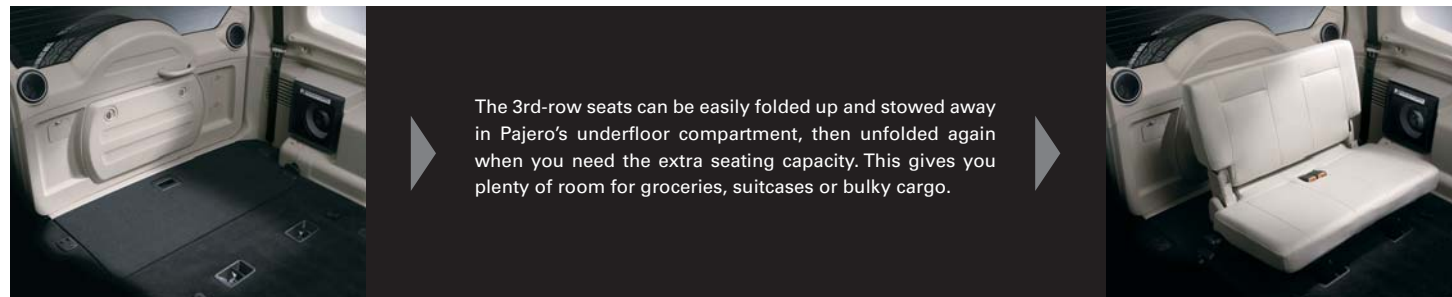

The 3rd-row seats can be easily folded up and stowed away in Pajero's underfloor compartment, then unfolded again when you need the extra seating capacity. This gives you plenty of room for groceries, suitcases or bulky cargo.

The Best in Navigation and Entertainment

Going for a drive should be an enjoyable experience. That's why the new Pajero features an original navigation system with an intuitive 7-inch touch-panel display that gets you where you want to go with ease and in style. And while on the road, the Rockford 12-speaker system puts you in the audience at the touch of a button. But while the driver's seat is surely the best seat in the house, rear passengers at least get to enjoy their favorite DVD movies on the 9-inch widescreen display.



Rockford Acoustic Design™ Premium Sound System

At the heart of Pajero's entertainment console lies a premium audio system specifically designed for Pajero by Rockford® Corporation. Being surrounded by 12 optimally positioned speakers, you get the most spectacular in-car theatrical acoustic atmosphere possible. A powerful rear subwoofer gives out deep, punchy bass while eleven other premium speakers deliver rich stereo surround sound.

Note: Rockford Acoustic Design™ and associated logos are trademarks of Rockford Corporation in the United States and other countries.

Navigation System

With the help of navigation in the impressive Mitsubishi Multi Communication System you can be guided by clear, turn-by-turn directions shown on the high definition touch-screen in both English and Arabic.



Top menu



Motorway mode

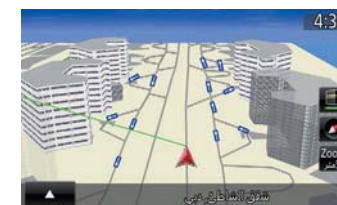

3D City (Palm Jumeirah)



Makkah direction (Green line)

Note: The information displayed varies according to your vehicle's specifications.



(Composite image)



DVD player



Remote control

9-inch Widescreen Display with DVD Player

Rear passengers can now spend long trips enjoying their favorite movies with the ceiling-mounted 9-inch widescreen display and DVD player. The AV input unit also allows them to connect game systems or computers. Viewers can use the surround sound system for premium quality listening.

Center Information Display

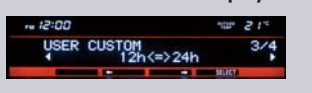

Customizable digital clock

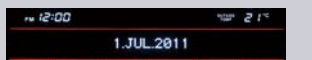

Calendar



Fuel economy



Elevation

The center information display continuously shows time, direction and outside temperature.

AWC (All Wheel Control)



More than a technology, All Wheel Control is our guiding philosophy. Incorporating an array of innovative systems into an integrated performance and control network, AWC delivers precise traction, power and slip control for each wheel independently to ensure complete driver control even in extreme handling conditions.



- 4-wheel Traction Control**
 - Monocoque Body with Built-in Ladder Frame
 - Front Midship Layout
 - Independent Suspension
- 4-wheel Power Control**
 - Super Select 4WD II (SS4 II)
 - Rear Differential Lock
- 4-wheel Slip Control**
 - Multi-mode ABS + EBD
 - ASTC and Rear Differential Lock
 - Independent Suspension

Monocoque Body with Built-in Ladder Frame

They say that superior off-road handling capability could only come at the expense of on-road smoothness. They have obviously never driven Pajero. By incorporating a lightweight and highly rigid monocoque body with a built-in ladder frame that provides added resistance to torsion and flexing and fixing them atop a dynamic independent

suspension, Pajero achieves an unprecedented combination of all-terrain control and luxury-sedan comfort. For added durability, Pajero now makes more extensive use of galvanized steel body panels, while the aluminum hood panel reduces weight for better handling.

Front Midship Layout

The engine on Pajero has been shifted back closer to the center of the vehicle. This places more weight between the axles to greatly improve handling and control. In addition, the engine position allows a better approach angle and provides added crumple zone protection in the event of an accident.

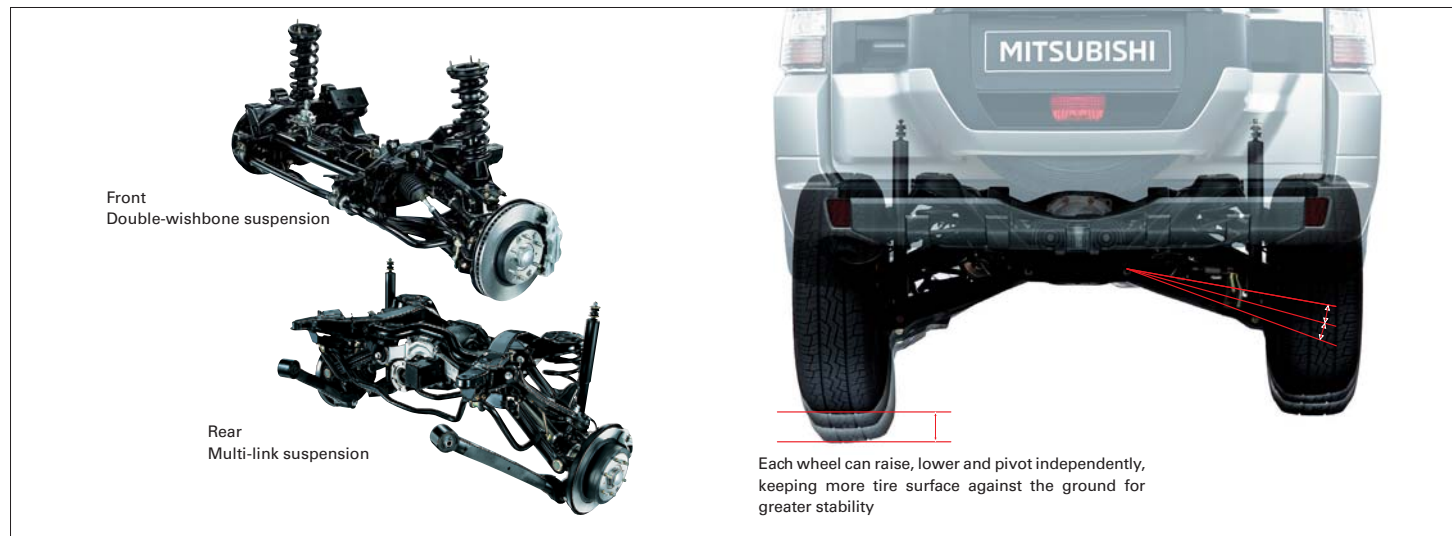

Each wheel can raise, lower and pivot independently, keeping more tire surface against the ground for greater stability

Independent Suspension

Pajero's rally-proven all-wheel independent suspension gives drivers confident, predictable handling in even the most unpredictable road conditions. The front double-wishbone and rear multi-link suspensions use coil springs to provide quick and natural response, especially when cornering.

Suspension Travel

The independent suspension, coil springs and monocoque body all work together to provide a greater degree of suspension travel. The result is impressive road-handling and greater stability even over the roughest off-road conditions.

ASTC (Active Stability and Traction Control)

ASTC utilizes a network of control units and intelligent sensors to monitor vehicle status as well as the driver's steering. As road and vehicle conditions change, ASTC manages the forces on all wheels by precisely controlling engine torque and braking force going to each one, providing improved vehicle control, trace ability and traction in all driving conditions. ASTC lets driving enthusiasts enjoy the full potential of Pajero in complete confidence.

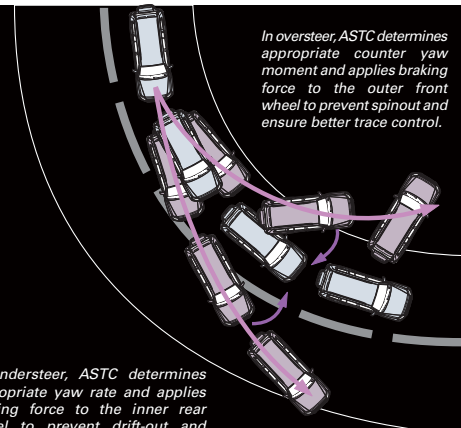
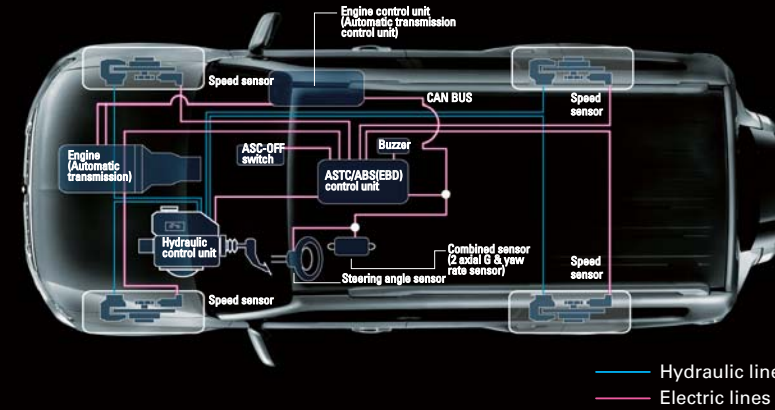

In oversteer, ASTC determines appropriate counter yaw moment and applies braking force to the outer front wheel to prevent spinout and ensure better trace control.

In understeer, ASTC determines appropriate yaw rate and applies braking force to the inner rear wheel to prevent drift-out and ensure better trace control.

ASTC calculates real-time vehicle status via sensor data. Whenever the potential for oversteer or understeer in corners is detected, ASTC determines the correct yaw for Pajero and applies braking force to the appropriate wheels. This enables drivers to maintain control even in slippery road conditions.

Note: The control capabilities of ASTC are supplemental only. Please drive safely and never rely solely on these functions while driving. Be sure to use the same specified type and size of tires on all 4 wheels. Do not install any aftermarket limited slip differential on your vehicle. Please see the owner's manual for additional information.



Rally-proven Technologies

Mitsubishi's advanced control technologies were first conceived and developed to meet the challenges of the world's most grueling rally courses. Proven under real-world conditions more demanding than any test track, they are now ready to go into Mitsubishi vehicles like Pajero.



Rear Differential Lock

Pajero also offers a rear differential lock for extreme off-road conditions, delivering the traction and handling needed to prevent wheel slip and navigate treacherous situations. Combining its low-torque performance with ASTC, drivers will find that no adventure is out of reach.



Super Select 4WD II (SS4 II)

Pajero's advanced SS4 II lets you shift between 2H, 4H and 4HLC modes at speeds of up to 100 km/h, providing on-demand control for highway performance or off-road traction whenever you need it.



Sports Mode for AT

Standard on all AT models, Sports Mode delivers the excitement of a manual shift while still providing the convenience of an automatic. Changing gears for enhanced response and performance with just a touch of the shifter, Sports Mode reminds you of what driving was like back when you first learned how.

Note: Super Select 4WD II lets you shift between 2H, 4H and 4HLC modes at speeds up to 100 km/h. Vehicle must be stopped when switching between 4HLC and 4LLc. Please see the owner's manual for additional information.

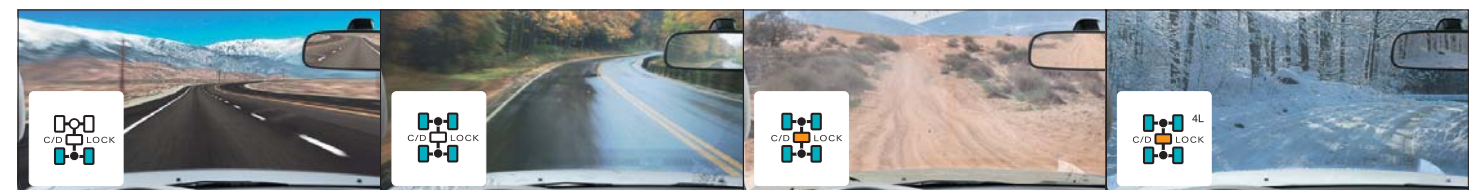

2H (2WD high range)

For cruising down the highway or just making a quick trip across town, 2H mode shifts you into rear-wheel drive for smooth, quiet, fuel-efficient performance.

4H (4WD high range)

When the weather gets bad and the roads start turning rough, 4H mode provides added traction. The dynamic front/rear torque split adjusts between 33:67 and 50:50 to give you greater control for high speed driving.

4HLC (4WD high range with locked center differential)

Keeping you on track even in rugged or slippery conditions, the 4HLC mode distributes power to all four wheels equally for off-road excitement with a steady sense of control.

4LLc (4WD low range with locked center differential)

Switch to 4LLc mode when you need all the tractor-like crawling power Pajero is capable of. Maximized low-end torque pulls you through even the roughest terrain, stickiest mud and deepest snow.

Engine Performance

The control that put Pajero in the Dakar Rally record books didn't come by skimping on engine power. The rugged outdoors are unforgiving on those who show up unprepared, which is why Pajero comes with a range of engines to provide ample power for all conditions.



3.8L 24-valve V6 SOHC MIVEC



Pajero's 3.8-liter engine puts an impressive 243 PS* at your command ensuring that you'll never be short on power. The new MIVEC (Mitsubishi Innovative Valve-timing Electronic Control) system varies the inlet valve timing and lift to optimize engine output across more of the rev range. The net result is enjoyment of the full potential of this powerhouse has to offer, with quicker starting response and sure, confident cruising performance.

*5-Door models

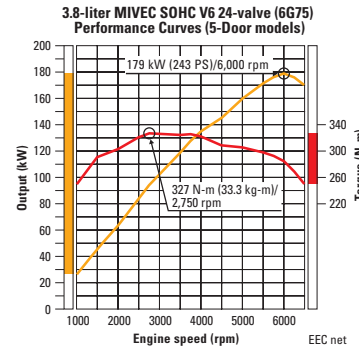

3.5L 24-valve V6 SOHC

The 3.5-liter V6 gasoline engine delivers an incredible amount of output power for high-range cruising on the open highway, while still providing plenty of torque to give you ample pulling capability when hauling heavy loads or help you get through rough driving conditions with confidence. The ECI-MULTI electronically controlled fuel injection system maximizes intake efficiency to produce more complete combustion, resulting in fewer emissions and giving you even, responsive acceleration you can depend on at any speed. And the single overhead camshaft design reduces engine vibration and mechanical noise for a smooth and quiet ride.

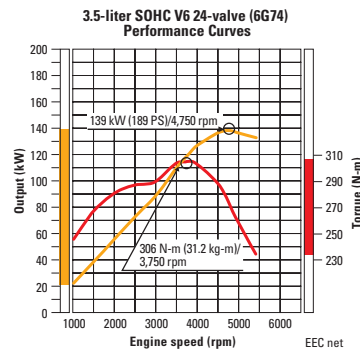

3.0L 24-valve V6 SOHC

For all the power you need to roam the city streets or enjoy the great outdoors up close. Equipped with multi-point fuel injectors for increased performance, this 24-valve V6 engine packs a punch not to be ignored.

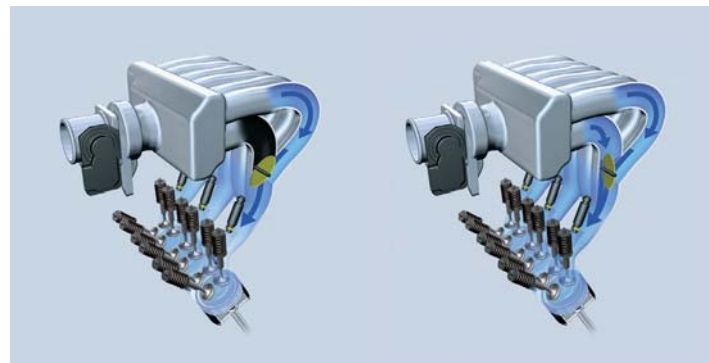
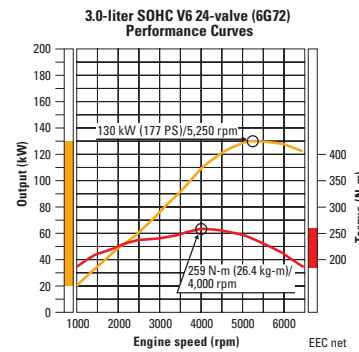

Variable Intake Manifold

Designed for the 3.8-liter engine, it further optimizes performance by adjusting air intake. At low and mid rpm ranges, only the primary port is used, increasing airflow speed for better torque and quicker starts, enhancing off-road escape-ability and fuel efficiency. At higher rpm ranges, both intake ports open to increase airflow volume and maximize power.



Cyclone-type Pre-air Cleaner

To perform at its best, an engine needs a continuous flow of clean air. The pre-air cleaner, featured on all models, increases air intake while filtering out dust and moisture. With the engine breathing easy, Pajero is ready to take on any road.

Safety and Reliability

Accidents happen. Mitsubishi knows that sometimes the road throws an unexpected surprise in your path, so Pajero is outfitted with an array of advanced active and passive safety technologies. Enjoy your drive with the peace of mind of knowing that you and your passengers are safe and secure.

Monocoque Body with Built-in Ladder Frame

The strength of Pajero's ladder frame has been nearly tripled over previous designs, providing even better resistance to torsional and flexural stresses without any further increase in weight. This rigidity translates to better handling and comfort over difficult road conditions and lower chance of control loss.



1 Dual-stage SRS Airbag System, Side and Curtain SRS Airbags (optional)

In the event of a forward collision, the driver and front passenger are both protected by front SRS airbags. To further increase safety, the onboard computer measures the force of impact and adjusts airbag deployment speed to best reduce the chance of injury to occupants. For side collisions, the driver and front passenger are protected by side mounted airbags set to deploy at just the right position regardless of seat position. Furthermore, curtain airbags mounted in the ceiling lining deploy to protect front and 2nd-row occupants.

Note: Airbags are part of a Supplemental Restraint System (SRS). To decrease the risk of injury from a deploying airbag, always wear your seat belt, sit upright in the middle of the seat and do not lean against the door. Always place children 12 and under in the rear seat and use appropriate child restraints. Never place a rear-facing infant restraint in the front seat. Please see the owner's manual and the instructions provided with your child restraint for additional information.

2 Automatic High Beam System (optional)

This in-vehicle camera sensor continuously monitors headlamps and tail lights of oncoming and preceding vehicles. If a nearing vehicle is detected by the camera sensor, the Automatic High Beam system automatically switches to low beam. Once there are no oncoming or preceding vehicles with headlamps or tail lights turned on in close proximity, the system immediately reverts back to high beam. Without the need for manual operation, driving is even more safe and comfortable.

3 Premium Security Alarm System (optional)

This theft protection system has been improved from earlier models. It is equipped with sensors to detect inclination and intrusions. In addition, the built-in battery power back-up activates an alarm when the battery wire is detached to prevent illegal access.

4 LED daytime running lamp with position lamp (optional)

Beyond enhancing safety by increase visibility when driving during the daytime, the LED daytime running lamps add a touch of style for good measure.

5 RISE Body

Using front and rear crumple zones to absorb and diffuse collision damage before it can reach the cabin interior, Pajero's RISE (Reinforced Impact Safety Evolution) body design is built to minimize occupant injury regardless of which direction trouble comes from. The rigid monocoque body provides further protection by encasing occupants within a steel framework that resists damage.

6 Safety-design Fuel Tank

Positioned ahead of the rear axle to help prevent leakage in a collision, Pajero's fuel tank is also guarded by a tough resin underprotector.

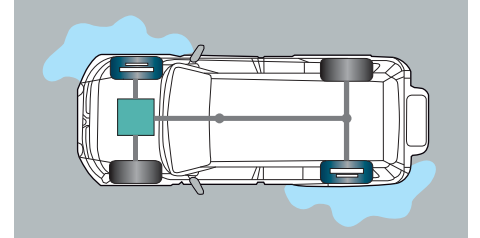

ASTC (Active Stability and Traction Control)

ASTC analyzes the forces acting on Pajero to anticipate control loss and take preventive measures. Additional braking is delivered to the wheels that need it, enabling you to hold your line precisely through each turn.

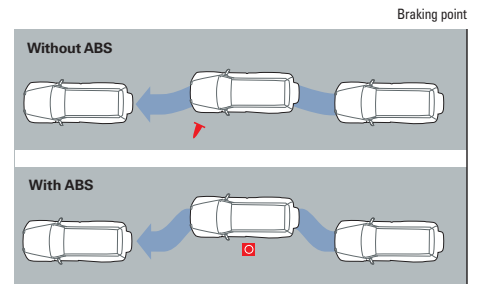

Multi-mode ABS (Anti-lock Braking System)

When the road throws you an unexpected curve, ABS ensures that you'll be ready. The 4-sensor, 4-channel system is matched to each SS4 II mode to ensure skid-free braking regardless of surface conditions.

Note: ABS can help a driver prevent unsafe situations while braking, but is never a substitute for safe driving. ABS does not always reduce stopping distances. Stopping distance can be influenced by many factors including road surface conditions and friction between the tires and the road surface.

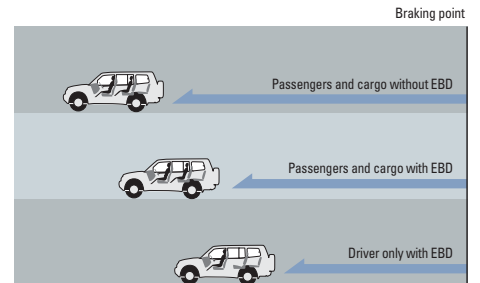

EBD (Electronic Brake-force Distribution)

EBD modulates each braking channel independently, providing additional force to the rear wheels when the vehicle is carrying passengers or cargo. This ensures you are able to come to a stop quickly and safely, regardless of load or road conditions.

5-DOOR GLX (PACKAGE OPTION FOR GLS)

3.8-liter V6 MIVEC ECI-MULTI (shown here) / 3.5-liter V6 ECI-MULTI / 3.0-liter V6 ECI-MULTI



Platinum Beige Metallic [S18]



Standard features:

- 265/65R17 tires with 17-inch light alloy wheels
- Black front skid plate
- Black power door mirrors
- Front seatback pockets
- Front seat height-adjustable headrests
- 2nd-row center armrest with cup holders
- 2nd-row 60:40 split bench seat
- 2nd-row height-adjustable headrest x 3
- 3rd-row front facing removable bench seat
- 3rd-row left side armrest with cup holders
- Mood lamp on ceiling
- Floor console box with upper and lower compartments and slide adjustable center armrest
- Tailgate pocket with lid
- Cargo room floor box
- Cargo room accessory socket
- Height-adjustable front seatbelt anchors
- Keyless entry system with 2 transmitters and master key (folding type x 2)



Beige interior with glossed wood-print accent panels
Note: Audio shown is optional



Beige Fabric seats
Note: Audio shown is optional

5-DOOR GLS

3.8-liter V6 MIVEC ECI-MULTI (shown here) / 3.5-liter V6 ECI-MULTI / 3.0-liter V6 ECI-MULTI



Sterling Silver Metallic [U25]



Exterior features:

- Color-keyed rear license plate garnish
- Chrome outer door handles
- Black door sashes
- Chrome power door mirrors with approach lamps and turn lamps
- Side garnishes with wheelhouse moldings
- Silver rear lower bumper

Note: LED daytime running lamp with position lamp and front fog lamp shown are optional.



Beige interior with glossed wood-print accent panels
Note: Audio shown is optional



Beige Fabric seats
Note: Audio shown is optional



Beige Leather seats
(black also available, refer to p. 17 for details)

Interior features:

- Leather-wrapped steering wheel
- Leather-wrapped gearshift and transfer knobs
- Leather-wrapped parking brake lever
- Chrome inner door handles

- Glossed wood-print accent panels
- Illuminated vanity mirrors with lids for sunvisors
- Electronic chromic rearview mirror
- Front foot lamps (both sides)

Equipment may vary by market. Please consult your local Mitsubishi Motors dealer/distributor for details.

5-DOOR GLS (GOLD EMBLEM PACKAGE)

3.8-liter V6 MIVEC ECI-MULTI (shown here) / 3.5-liter V6 ECI-MULTI / 3.0-liter V6 ECI-MULTI



Platinum Beige Metallic [S18]



Note: LED daytime running lamp with position lamp, front fog lamp and 18-inch light alloy wheels shown are optional.

Package features:

- Gold front three-diamond badge
- Gold hood ornament
- Gold rear three-diamond badge
- Gold "PAJERO" badge
- Gold "3.8 V6" badge on tailgate for 3.8-liter models and Gold "V6" badge on tailgate for 3.5 and 3.0-liter models
- Light alloy wheels with gold emblem center caps
- Chrome side protector moldings



Beige interior with glossed wood-print accent panels
Note: Audio shown is optional



Beige Fabric seats
Note: Audio shown is optional



Beige Leather seats
(black also available, refer to p. 17 for details)

Interior features:

- Leather-wrapped steering wheel
- Leather-wrapped gearshift and transfer knobs
- Leather-wrapped parking brake lever
- Chrome inner door handles

- Glossed wood-print accent panels
- Illuminated vanity mirrors with lids for sunvisors
- Electronic chromic rearview mirror
- Front foot lamps (both sides)

Equipment may vary by market. Please consult your local Mitsubishi Motors dealer/distributor for details.

3-DOOR GLX (PACKAGE OPTION FOR GLS)

3.8-liter V6 MIVEC ECI-MULTI / 3.5-liter V6 ECI-MULTI (shown here)



Platinum Beige Metallic [S18]

Standard features:
Same as 5-Door GLX model, excluding 3rd-row front facing seats, cargo room floor box, cargo room accessory socket, 2nd-row side armrest with cup holders and 3rd-row left side armrest with cup holders



Black interior with metallic accent panels
Note: Audio shown is optional



Black Fabric seats
Note: Audio shown is optional

3-DOOR GLS

3.8-liter V6 MIVEC ECI-MULTI (shown here) / 3.5-liter V6 ECI-MULTI



Eiger Gray Metallic [U19]

Exterior and interior features:
Same as 5-Door GLS model, excluding black door sashes and color-keyed rear license plate garnish



Note: LED daytime running lamp with position lamp and front fog lamp shown are optional.



Black interior with glossed wood-print accent panels
Note: Audio shown is optional



Black Fabric seats (optional black Leather seats also available, refer to p. 17 for details)
Note: Audio shown is optional

3-DOOR GLS (GOLD EMBLEM PACKAGE)

3.8-liter V6 MIVEC ECI-MULTI (shown here) / 3.5-liter V6 ECI-MULTI



Platinum Beige Metallic [S18]

Package features:

- Gold front three-diamond badge
- Gold hood ornament
- Gold rear three-diamond badge
- Gold "PAJERO" badge
- Gold "3.8 V6" badge on tailgate for 3.8-liter models and Gold "V6" badge on tailgate for 3.5-liter models
- Light alloy wheels with gold emblem center caps



Note: LED daytime running lamp with position lamp, front fog lamp and 18-inch light alloy wheels shown are optional.

Equipment may vary by market. Please consult your local Mitsubishi Motors dealer/distributor for details.

Exterior Colors



Sterling Silver Metallic [U25] **NEW COLOR**



Deep Bronze Metallic [C18]



Medium Red [P17]



Platinum Beige Metallic [S18]



Eiger Gray Metallic [U19]



Warm White Mica [W23]



White Solid [W37]



Black Mica [X37]



Sterling Silver Metallic / Eiger Gray Metallic [U4U]

Seat Materials and Colors



Optional Leather [Beige] 5-Door GLS only



Optional Leather [Black] GLS only



Fabric [Beige] 5-Door GLX and GLS only



Fabric [Black] GLX and GLS

Exterior and Interior Color Combinations

Model	5-Door		3-Door	
	GLX Package	GLS	GLX Package	GLS
Seat materials and colors	Fabric (Black/Beige)	Fabric (Black/Beige) or Opt. Leather (Beige/Black)	Fabric (Black)	Fabric (Black) or Opt. Leather (Black)
Exterior colors				
Sterling Silver Metallic [U25]	■	■	■	■
Deep Bronze Metallic [C18]	■	■	■	■
Medium Red [P17]	■	■	■	■
Platinum Beige Metallic [S18]	■	■	■	■
Eiger Gray Metallic [U19]	■	■	■	■
Warm White Mica [W23]	■	■	■	■
White Solid [W37]	■	■	■	■
Black Mica [X37]	■	■	■	■
Sterling Silver Metallic / Eiger Gray Metallic [U4U]	—	■	—	—

■ : Available — : Not available

Note: Colors shown may differ slightly from actual colors due to printing process. Please consult your local Mitsubishi dealer/distributor for actual colors.

STANDARD AND OPTIONAL EQUIPMENT

Model	Body type		5-Door		3-Door	
			4WD		4WD	
			GLS		GLS	
Engine		3.8L V6	3.5L V6 3.0L V6	3.8L V6	3.5L V6	
Transmission		5AT	5AT	5AT	4AT	
Performance	Engines	3.8-liter 24-valve V6 SOHC MIVEC ECI-MULTI engine (6G75)	■	—	■	—
		3.5-liter 24-valve V6 SOHC ECI-MULTI engine (6G74)	—	■	—	■
		3.0-liter 24-valve V6 SOHC ECI-MULTI engine (6G72)	—	■	—	—
	Transmissions	INVECS-II 5-speed automatic transmission with Sports Mode	■	■	■	—
		INVECS-II 4-speed automatic transmission with Sports Mode	—	—	—	■
	Super Select 4WD II (SS4 II)		■	■	■	■
	Rear differential lock		□	□	□	□
	Tires and wheels	265/60R18 tires with 18-inch light alloy wheels	📷 01	□	□	□
		265/65R17 tires with 17-inch light alloy wheels	📷 02	■	■	■
	Gold emblem wheel center caps		□	□	□	□
Safety	Active Stability and Traction Control (ASTC) with brake assist		■	■	■	■
	Multi-mode ABS (Anti-lock Braking System) with EBD (Electronic Brake-force Distribution)		■	■	■	■
	SRS airbags	Driver's and front passenger's front SRS airbags (dual-stage)	📷 03	■	■	■
		Front seat side and curtain SRS airbags	📷 04	□	□	□
	Seatbelts	Front 3-point ELR seatbelt × 2	■	■	■	■
		Height-adjustable front seatbelt anchors	■	■	■	■
		Front seatbelt pretensioners	□	□	□	□
		2nd-row 3-point ELR seatbelt × 3	■	■	■	■
		3rd-row 3-point ELR seatbelt × 2	■	■	—	—
	Front and rear side door impact bars (front only for 3-Door models)		■	■	■	■
	Child-protection rear door locks		■	■	—	—
	High-mount stop lamp		■	■	■	■
	Rear sensors		□	□	□	□
	Premium security alarm system		📷 05	□	□	□
	Fire extinguisher, first-aid kit and emergency triangle		■	■	■	■
	Shift lock with key interlock		■	■	■	■
	Engine immobilizer		■	■	■	■
	Tether anchor for ISO-FIX child seat		□	□	□	□
	Tire Pressure Monitoring System (TPMS)		■	■	■	■
	Exterior	Chrome front grille (dark gray paint radiator grille and front bumper center)		📷 06	■	■
Chrome front grille (matt black paint radiator grille and front bumper center)		□	□	□	□	
Silver hood ornament		□	□	□	□	
Headlamps		Halogen headlamps	■	■	■	■
		Discharge headlamps	📷 07	□	□	□
		Automatic high beam	📷 21	□	□	□
		Headlamp washers	📷 08	□	□	□
LED daytime running lamp with position lamp		📷 09	□	□	□	
Front fog lamp		□	□	□	□	
Rear fog lamp		📷 11	■	■	■	
Silver front lower bumper / Silver rear lower bumper		📷 12	■	■	■	
Black front lower bumper / Black rear lower bumper		☆	☆	☆	☆	
Tailgate air deflector		📷 19	□	□	□	
Windows		Laminated green windshield glass	■	■	■	■
		Tempered green front and rear door glass, rear quarter glass and rear window glass	■	■	■	■
		Chrome windshield molding	■	■	■	■
		Windshield sunshade	■	■	■	■
		Silence package	□	□	—	—
Rear window defogger		■	■	■	■	
Variable intermittent windshield wipers and washers		■	■	■	■	
Rear intermittent wiper and washer		📷 20	■	■	■	
Chrome power door mirrors with approach lamps and turn lamps		📷 10	■	■	■	
Black power door mirrors		☆	☆	☆	☆	
Chrome outer door handles		📷 14	■	■	■	
Black outer door handles		☆	☆	☆	☆	
Black door sashes		■	■	—	—	
Black door sashes deletion		☆	☆	—	—	
Side garnishes with wheelhouse moldings		■	■	■	■	
Chrome side protector moldings		📷 14	☆	—	—	
Side steps		📷 15	□	□	□	
Front and rear mudguards		📷 16	■	■	■	
Black roof rails		📷 18	□	□	□	
Color-keyed rear license plate garnish		■	■	—	—	
Dark gray rear license plate garnish		☆	☆	■	■	
Tailgate garnish		—	—	■	■	
Front and rear towing hooks		■	■	■	■	
Rear pintle hook		□	□	□	□	
Cockpit	4-spoke leather-wrapped steering wheel		■	■	■	■
	4-spoke wood and leather-wrapped steering wheel with audio controls and cruise control		📷 23	□	□	□
	4-spoke leather-wrapped steering wheel with audio controls and cruise control		□	□	□	□
	Power steering / Tilt-adjustable steering column		■	■	■	■
	Leather-wrapped gearshift knob, transfer knob and parking brake lever		■	■	■	■
	High-contrast back-lit meters and gauges with tachometer, 4WD position display and rheostat		📷 22	■	■	■
	Illuminated ignition key cylinder		■	■	■	■
	Aluminum pedals		📷 25	□	□	□
Scuff plate with accent		□	□	—	—	
Seats	Leather seats / Front power seats / Driver's seat lumbar support / Front seat side and curtain SRS airbags / Retractable assist grip × 6 (4 for 3-Door models)		□	□	□	□
	Front seats	Manual sliding and reclining adjusters / Driver's seat manual height adjuster	■	■	■	■
		Front passenger's side easy-access walk-in system for rear passengers	—	—	■	■
		Driver's power seat with lumbar support	📷 33	□	□	□
		Height-adjustable headrest × 2	■	■	■	■
Driver's and front passenger's seatback pockets		■	■	■	■	

Model	Body type		5-Door		3-Door	
			4WD		4WD	
			GLS		GLS	
Engine		3.8L V6	3.5L V6 3.0L V6	3.8L V6	3.5L V6	
Transmission		5AT	5AT	5AT	4AT	
Seats (continued)	2nd-row seats	60:40 split bench seat	■	■	■	■
		Reclining adjusters	■	■	■	■
		Manual folding and tumbling function	■	■	■	■
		Center armrest with cup holders	📷 34	■	—	—
		Side armrest with cup holders	📷 36	—	—	■
	3rd-row seats	Height-adjustable headrest × 3	■	■	■	■
		Front-facing removable bench seat	📷 35	■	—	—
		Underfloor storage function	■	■	—	—
		Headrest × 2	□	□	—	—
		Glossed wood-print or metallic accent panels (instrument panel, floor console and door trims)		■	■	■
Chrome inner door handles		📷 32	■	■	■	
Silver power window switch panels		■	■	■	■	
Center information display		■	■	■	■	
Lockable glove box		■	■	■	■	
Front cup holders on floor console		■	■	■	■	
Floor console box with upper and lower compartments and slide adjustable center armrest		■	■	■	■	
Beverage cooler built into floor console box (accessory socket deletion)		□	□	□	□	
Front door pockets		■	■	■	■	
3rd-row left side armrest with cup holders		■	■	—	—	
Accessory socket on instrument panel		📷 29	■	■	■	
Accessory socket inside floor console box		■	■	■	■	
Cigarette lighter / Removable cup-type ashtray		□	□	□	□	
Fuel lid opener		■	■	■	■	
Illuminated vanity mirror with lid and ticket holder for sunvisors		📷 31	■	■	■	
Vanity mirror and ticket holder for sunvisors		☆	☆	☆	☆	
Cabin lamps	Front room lamp with map lamps		■	■	■	■
	Personal lamps for 2nd-row passengers		■	■	■	■
	Mood lamp on ceiling		■	■	■	■
	Front foot lamps (both sides)		■	■	■	■
	2nd-row foot lamp behind floor console		■	■	—	—
	Door courtesy lamps (all side doors)		■	■	■	■
	Electronic chromic rearview mirror		■	■	■	■
	Retractable assist grip × 6 (4 for 3-Door models)		□	□	□	□
	Retractable assist grip × 3		■	■	■	■
	Cargo room	Tailgate pocket with lid		■	■	■
Cargo room floor box		■	■	■	■	
Cargo room hook × 4		■	■	■	■	
Cargo room accessory socket		■	■	—	—	
Tonneau cover		□	□	□	□	
Cargo room lamp		■	■	■	■	
Comfort and Convenience	Ventilation		■	■	■	■
	Fully automatic air conditioner		📷 28	■	■	■
	Manually controlled rear cooler		■	■	—	—
	2nd-row seat heater ducts		■	■	■	■
	Central door locking system		■	■	■	■
	Keyless entry system with 2 transmitters and master key (folding type × 2)		📷 24	■	■	■
	Power windows with time-delay and driver's auto-down function		📷 13	■	■	■
	Power tilt and sliding sunroof with anti-trapping function		📷 17	□	□	□
	High-grade silence package		□	□	□	□
	6 speakers (4 speakers and 2 tweeters)		■	■	■	■
Audio and Media	Mitsubishi Multi Communication System with SD Navigation, AM/FM radio, CD player, center display with touch panel (digital clock, audio information and rearview camera) and USB port		📷 30	□	□	□
	Mitsubishi Multi Communication System with SD Navigation, Rockford Acoustic Design™ premium sound system with AM/FM radio, CD player, center display with touch panel (digital clock, audio information and rearview camera), 12 speakers (7 speakers, 4 tweeters and 1 subwoofer) and USB port		📷 26 📷 30	□	□	—
	Mitsubishi Multi Communication System with SD Navigation, 420 W MITSUBISHI POWER SOUND SYSTEM with AM/FM radio and CD player, center display with touch panel (digital clock, audio information and rearview camera), 8 speakers in 6 locations (4 speakers and 4 tweeters) and USB port		📷 30	—	—	□
	Rockford Acoustic Design™ premium sound system*1 with AM/FM radio, CD player, center display with touch panel (digital clock, audio information and rearview camera), 12 speakers (7 speakers, 4 tweeters and 1 subwoofer) and USB port		📷 27 📷 30	□	□	—
	AM/FM radio, CD player, center display with touch panel (digital clock, audio information and rearview camera) and USB port		📷 30	□	□	□
	AM/FM radio, CD player and USB port		📷 30	□	□	□
	Bluetooth® hands-free cellular phone interface system*2 with voice recognition and USB port / Link system		📷 30	□	□	□
	Rear entertainment system (9-inch display and DVD player with two sets of infrared headphones and video jack)		□*3	□*3	—	—
	Built-in glass antenna		■	■	■	■
	Package Options	GLX Package: Chrome front grille (matt black paint radiator grille and front bumper center) / Black windshield molding / Black front and rear lower bumper / Black power door mirrors / Black outer door handles / Black door sashes deletion (5-Door models only) / Side garnishes with wheelhouse moldings deletion / Tailgate garnish deletion (3-Door models only) / Dark gray rear license plate garnish (5-Door models only) / Urethane steering wheel / Urethane gearshift knob, transfer knob and parking brake lever / Color-keyed inner door handles / Vanity mirror and ticket holder for sunvisors / Front foot lamps deletion / Day-and-night rearview mirror		□	□	□
Gold Emblem Package: Gold front and rear three-diamond badges / Gold hood ornament / Gold "PAJERO" badge / Gold "3.8 V6" badge on tailgate for 3.8-liter models and Gold "V6" badge on tailgate for 3.5 and 3.0-liter models / Light alloy wheels with gold emblem center caps / Chrome side protector moldings (5-Door models only)		📷 37	□	□	□	
GLS Basic Exterior Package: Chrome front grille (matt black paint radiator grille and front bumper center) / Black windshield molding / Black front and rear lower bumper / Black power door mirrors / Black outer door handles / Black door sashes deletion / Dark gray rear license plate garnish (5-Door models only)		□	□	□	□	
GLS Basic Interior Package: Color-keyed inner door handles / Vanity mirror and ticket holder for sunvisors / Front foot lamps deletion / Day-and-night rearview mirror		□	□	□	□	
		□	□	□	□	

■ : Standard □ : Optional ☆ : Available in Package Options only — : Not available

*1: Rockford Acoustic Design™ and associated logos are trademarks of Rockford Corporation in the United States and other countries.

*2: The Bluetooth® word mark and logos are registered trademark owned by the Bluetooth SIG, Inc. and any use of such marks by MITSUBISHI MOTORS CORPORATION is under license.

*3: Available only with MMCS (Mitsubishi Multi Communication System).

Note: Equipment may vary by market. Please consult your local Mitsubishi Motors dealer/distributor for details.

STANDARD AND OPTIONAL EQUIPMENT

GOLD EMBLEM PACKAGE



Gold hood ornament 📷 37



Gold front and rear three-diamond badges 📷 37



Gold "PAJERO" badge 📷 37



Gold engine badge on tailgate (shown with 3.8L models) 📷 37



Gold emblem center caps (shown with optional 18-inch light alloy wheel) 📷 37



265/60R18 tires with 18-inch light alloy wheels 📷 01



265/65R17 tires with 17-inch light alloy wheels 📷 02



Driver's and front passenger's front SRS airbags (dual-stage) 📷 03



Front seat side and curtain SRS airbags 📷 04



Premium security alarm system 📷 05



Chrome front grille 📷 06



Discharge headlamps 📷 07



Headlamp washers 📷 08



LED daytime running lamp 📷 09



Chrome power door mirrors with approach lamps and turn lamps 📷 10



Rear fog lamp 📷 11



Silver front lower bumper 📷 12



Power windows with time-delay and driver's auto-down function 📷 13



Chrome outer door handles and chrome side protector moldings 📷 14



Side steps 📷 15



Front and rear mudguards 📷 16



Power tilt and sliding sunroof with anti-trapping function 📷 17



Black roof rails 📷 18



Tailgate air deflector 📷 19



Rear intermittent wiper and washer 📷 20



Automatic high beam (camera shown) 📷 21



High-contrast back-lit meters and gauges with tachometer, 4WD position display and rheostat 📷 22



4-spoke wood and leather-wrapped steering wheel with audio controls and cruise control 📷 23



Keyless entry system with 2 transmitters and master key (folding type x 2) 📷 24



Aluminum pedals 📷 25



Mitsubishi Multi Communication System (MMCS) with SD navigation 📷 26



Rockford Acoustic Design™ premium sound system with AM/FM radio, CD player, center display with touch panel and 12 speakers 📷 27



Fully automatic air conditioner 📷 28



Accessory socket on instrument panel 📷 29



USB port 📷 30



Illuminated vanity mirror with lid and ticket holder for sunvisors 📷 31



Chrome inner door handles 📷 32



Driver's power seat 📷 33



2nd-row seat center armrest with cup holders (5-door only) 📷 34



Front-facing removable bench seat 📷 35



2nd-row seat side armrest with cup holders (3-door only) 📷 36

Note: Some of the equipment may vary in appearance or availability according to market. Please consult your local Mitsubishi dealer/distributor for more detailed information.

SPECIFICATIONS

MODEL	Body type	5-Door			3-Door	
	Drive system	4WD			4WD	
DIMENSIONS AND WEIGHTS	Engine	3.8 V6 MIVEC	3.5 V6	3.0 V6	3.8 V6 MIVEC	3.5 V6
	Price class	GLS	GLS	GLS	GLS	GLS
	Model code	V97WLYXYULW (EURO 4)	V95WLYXVLW (EURO 2)	V93WLYXVLW (EURO 4)	V87WMYXYULW (EURO 4)	V85WMRXVLW (EURO 2)
	Overall length	4,900			4,385	
	Overall width	1,875 (GLX Package: 1,845)			1,875 (GLX Package: 1,845)	
PERFORMANCE	Overall height	1,870 (with roof rails: 1,900)			1,850 (with roof rails: 1,880)	
	Wheelbase	2,780			2,545	
	Ground clearance	235			235	
	Curb weight	2,165	2,135	2,110	1,975	1,960
	Gross vehicle weight	2,765	2,720	2,720	2,560	
	Seating capacity	7			5	
	Max. speed*	200	180	175	200	180
	Max. climbing ability	0.7			0.7	
	Approach angle	36.6°			36.7°	
	Ramp break-over angle	22.5°			25.2°	
Departure angle	25.0°			34.8°		
Min. turning radius	5.7			5.3		
ENGINE	Type (code)	3.8-liter 24-valve V6 SOHC MIVEC (6G75)	3.5-liter 24-valve V6 SOHC (6G74)	3.0-liter 24-valve V6 SOHC (6G72)	3.8-liter 24-valve V6 SOHC MIVEC (6G75)	3.5-liter 24-valve V6 SOHC (6G74)
	Displacement	3,828	3,497	2,972	3,828	3,497
	Max. output (EEC net)	179 (243)/6,000	139 (189)/4,750	130 (177)/5,250	177 (241)/6,000	139 (189)/4,750
	Max. torque (EEC net)	327 (33.3)/2,750	306 (31.2)/3,750	259 (26.4)/4,000	327 (33.3)/2,750	306 (31.2)/3,750
FUEL SYSTEM	Fuel supply equipment	ECI-MULTI (Electronic Controlled Injection - Multi Point Injection)			ECI-MULTI (Electronic Controlled Injection - Multi Point Injection)	
	Fuel tank capacity	88			69	
DRIVE SYSTEM	Type	Super Select 4WD II (SS4 II)			Super Select 4WD II (SS4 II)	
TRANSMISSION	Type	INVECS-II 5-speed automatic with Sports Mode			INVECS-II 5-speed automatic with Sports Mode	INVECS-II 4-speed automatic with Sports Mode
STEERING	Type	Rack-and-pinion, power assisted			Rack-and-pinion, power assisted	
SUSPENSIONS	Front	Double-wishbone, coil springs with stabilizer bar			Double-wishbone, coil springs with stabilizer bar	
	Rear	Multi-link, coil springs with stabilizer bar			Multi-link, coil springs with stabilizer bar	
BRAKES	Front	Ventilated discs (4-pot)	Ventilated discs (2-pot)	Ventilated discs (2-pot)	Ventilated discs (2-pot)	Ventilated discs (2-pot)
	Rear		Ventilated discs		Ventilated discs	Ventilated discs
TIRES	Front and rear	265/65R17 112H			265/65R17 112H	

*Measured by MITSUBISHI MOTORS CORPORATION.

Note: These specifications are subject to change without notice. Please consult your local Mitsubishi dealer/distributor for detailed specifications.

DIMENSIONAL VIEWS

5-Door GLS

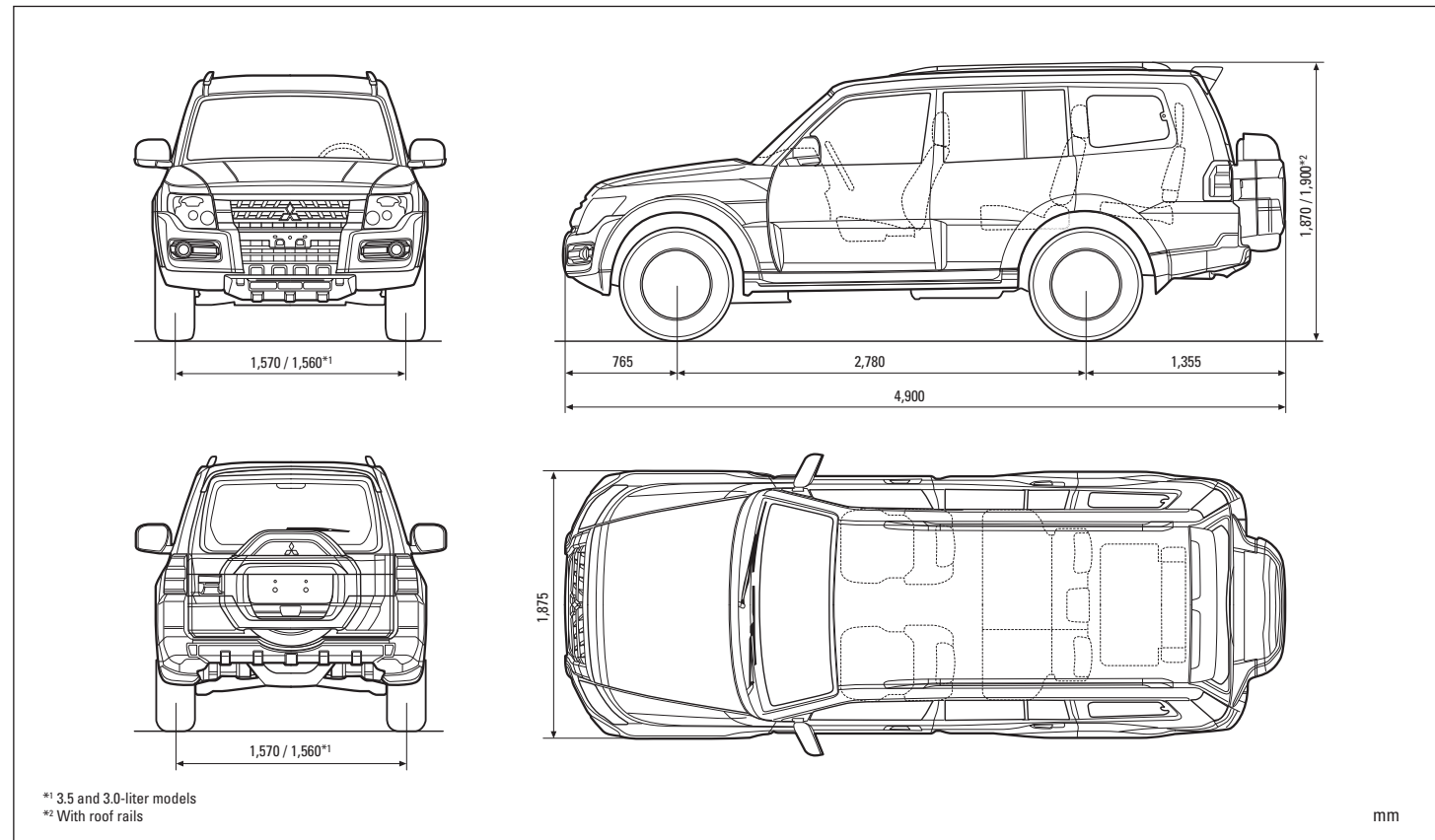

DIMENSIONAL VIEWS

3-Door GLS

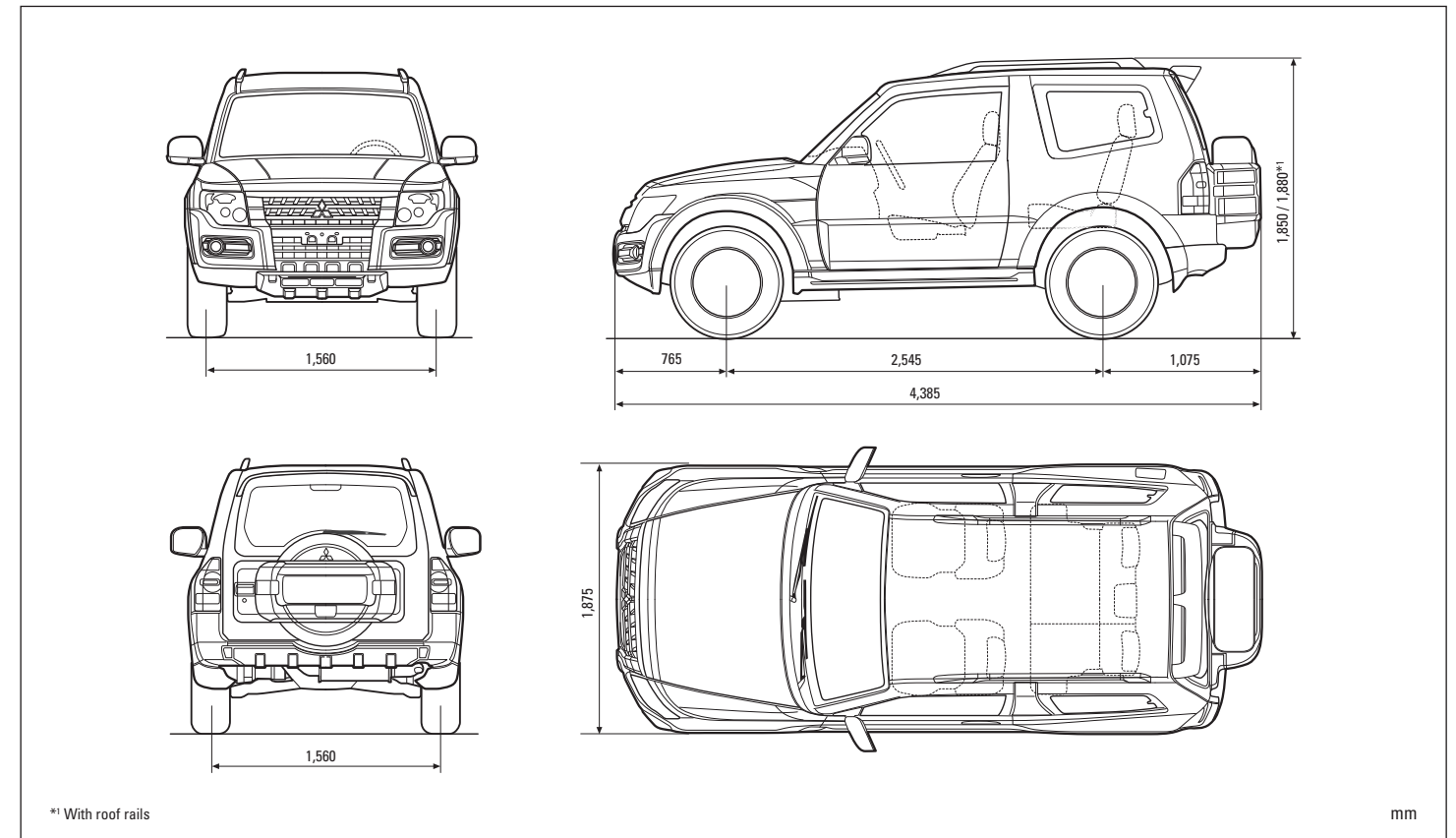



www.facebook.com/MitsubishiMotors.en



www.instagram.com/mitsubishimotorsofficial



www.youtube.com/user/MitsubishiMotorsAd



www.mitsubishi-motors.com

©2018 – 2019 Mitsubishi Motors Corporation. All rights reserved.
Gc/PE30C342Mar.18EG Printed in Japan



The paper used in this catalogue has been certified by the FSC™ (Forest Stewardship Council™) as having been produced through a 'chain of custody' system of forestry management, tracking and production oversight that ensures responsible consideration for the earth's ecosystem. Mitsubishi Motors has adopted the combined use of FSC-certified paper and recycled paper in our efforts to reduce CO₂ emissions and promote more efficient use of natural resources. In this way, we hope to contribute to greater protection of the environment.