



NOTE e-POWER



# NOTE

## e-POWER

### The urban hatchback that breaks the mould

Turn heads and set yourself apart from the norm with the bold, all-new Nissan Note e-POWER. Powered by Nissan's second-generation, award-winning<sup>1</sup> e-POWER system, it offers a simple yet powerfully modern design, a trend-setting interior and thrilling acceleration.



<sup>1</sup> Named 2019 and 2021 "Technology of the Year" by the Automotive Researchers' and Journalists' Conference of Japan (RJC); and "Best Innovation" at Torque Honours 2020.

Actual specifications and features may vary from image(s) shown.

The all-new Nissan Note e-POWER has arrived

The Note e-POWER showcases Nissan's latest design concept, Timeless Japanese Futurism. The simple, yet powerfully modern and distinctive Japanese approach sets it apart from other hatchbacks. It also features the second generation of Nissan's acclaimed e-POWER electric powertrain. Extensively redesigned and redeveloped, the system produces more torque, a higher-quality driving experience and improved efficiency.

The Note e-POWER's advanced safety technology offers 360 degrees of coverage to give drivers added assistance and peace of mind on the road. A first for Nissan, 1,470 MPa ultra-high tensile steel has been adopted in the vehicle chassis, contributing to both weight reduction and improved passive safety performance. Nissan Intelligent Driving technologies are available on the Note e-POWER, giving drivers more confidence through enhanced safety, control and comfort.

#### Body colours

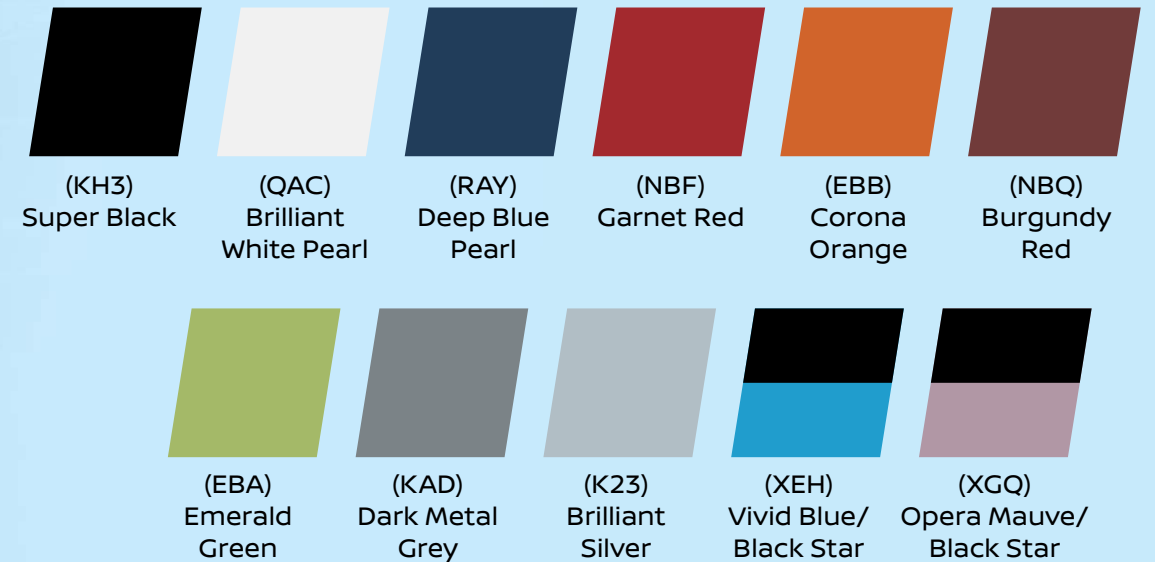

# e-POWER

Revolutionary award-winning technology



## Experience a fun and improved driving experience

By incorporating the strength, smoothness and quietness of Nissan's second-generation e-POWER system, the all-new Nissan Note e-POWER boasts an excellent driving experience, with everything you need to power your drive.



Actual specifications and features may vary from images shown.

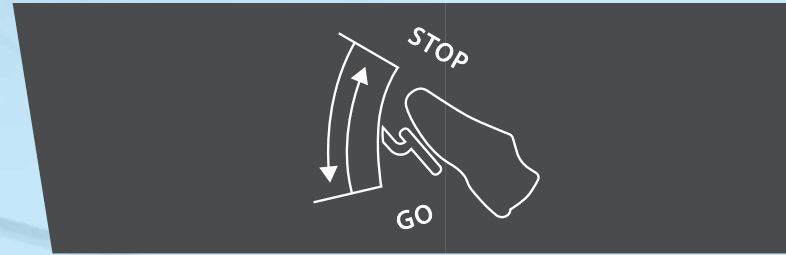

### One-Pedal Drive

This feature allows the driver to start, accelerate and decelerate using only the accelerator pedal. Lift off the accelerator pedal and One-Pedal Drive mimics stepping on the brake pedal, allowing the vehicle to slow down.

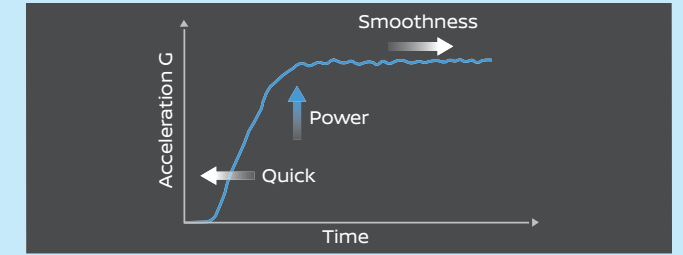

Improved electric motor output and torque. Instantaneous torque with 100% electric drive that allows driver and passengers to better enjoy every ride.

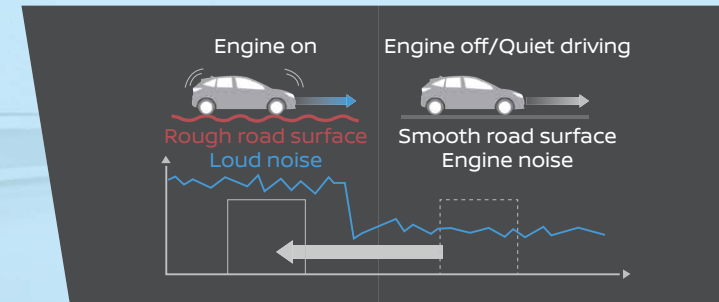

### Good cabin quietness

A 100% electric motor drive and improved sound insulation create a tranquil interior for uninterrupted conversations with your loved ones.

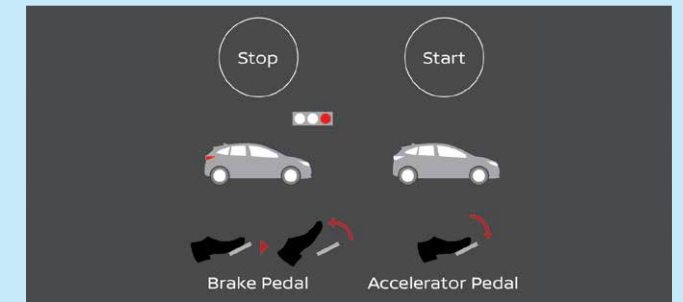

### Electronic Parking Brake with Auto Hold\*

The braking force is automatically maintained when the driver takes his foot off the brake pedal, providing added convenience while idling at a traffic junction.

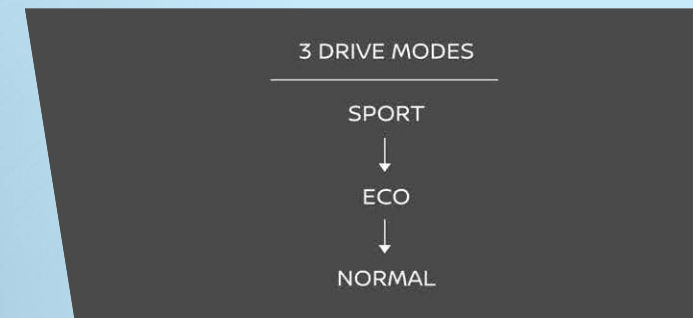

### Discover enhanced driving

With the SPORT mode, drivers can experience more powerful acceleration. In addition, both SPORT and ECO modes feature One-Pedal Drive. One-Pedal Drive greatly reduces the need to shift from one pedal to the other, making driving simpler and more engaging.

\*On slopes, drivers need to step firmly on the brake pedal until it is activated. Do not use it on steep slopes or slippery roads, even if the function is working, as it may cause the vehicle to start moving. Turn off the feature during a car wash and when being towed.



## Noteworthy design

There's nothing better than getting to your destination in comfort and style. The Nissan Note e-POWER allows just that with cutting-edge technology within its interior, designed for maximum convenience, comfort and connectivity wherever you go.

*Actual specifications and features may vary from images shown.*

### Exterior



Sleek automatic LED headlamps, featuring four in-line projector lights, and fog lamps



Character lines extend from the front, carving the side profile and transitioning through the slim, horizontally-continuous rear combination lamps

### Interior



D-shaped steering wheel with multi-function controls (settings, audio, hands-free phone)



A wide opening to a spacious 340-litre boot, making loading and unloading an easier experience.



USB power socket (type A-1) for smartphone connectivity and charging.



Elegant and stylish black upholstery

# Safety built all around you

The Note e-POWER's advanced safety technologies offer 360 degrees of coverage to give you added assistance and peace of mind on the road.

## Front



Intelligent Emergency Braking with Pedestrian Detection



Intelligent Forward Collision Warning



High Beam Assist

## Rear



Intelligent Rearview Mirror

## Side



Lane Departure Warning



Intelligent Lane Intervention



Intelligent Driver Alertness



Stay safe against the unexpected



## Intelligent Forward Collision Warning

This safety technology detects changes in the situation ahead that cannot be seen from the vehicle and supports the prevention of forward collisions.

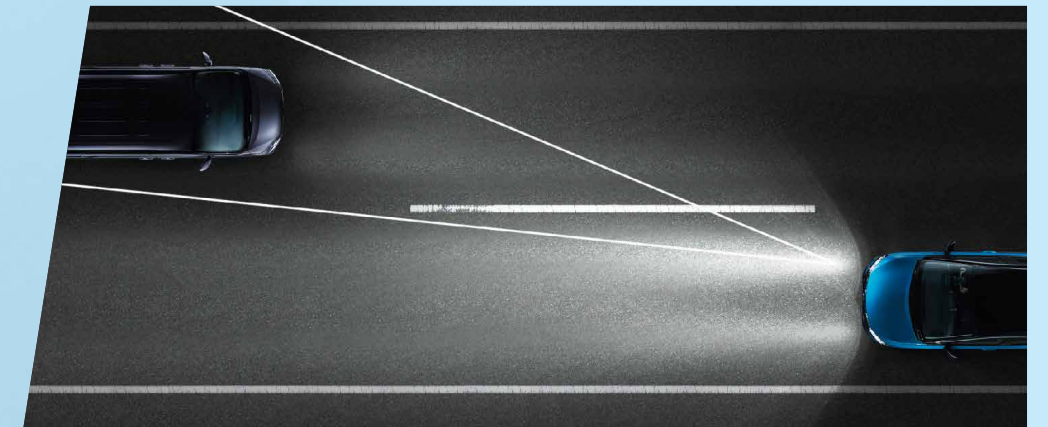

## High Beam Assist

This system automatically switches the headlamps setting to low beam from high beam when it detects a vehicle or pedestrian ahead, supporting safer driving.

## Equipment

	LITE	PREMIUM
<b>Exterior</b>		
Signature V-Motion Grille	▪	▪
Automatic LED Headlamps	▪	▪
16-inch Alloy Wheels		▪
16-inch Steel Wheels with Hub Cap	▪	
Electrical Retractable Side Mirrors with LED Indicators	▪	▪
Front Fog Lamps	▪	▪
Sharkfin Antenna	▪	▪
<b>Interior</b>		
Nissan Intelligent Key with Keyless Entry & Push Start Ignition	▪	▪
9-inch Touchscreen Infotainment System with Apple CarPlay / Android Auto	▪	▪
7-inch Digital TFT Instrument Display	▪	▪
Zero Gravity Seats	▪	▪
Black Nappa Leather Upholstery		▪
Fabric Upholstery	▪	
D-shaped Steering Wheel with Multi-function Controls	▪	▪
Auto Climate Control Air-Conditioning	▪	▪
60:40 Foldable Rear Seats	▪	▪
<b>Nissan Intelligent Mobility</b>		
One-Pedal Drive	▪	▪
Intelligent Emergency Braking with Pedestrian Detection	▪	▪
Intelligent Forward Collision Warning	▪	▪
Intelligent Lane Intervention	▪	▪
Lane Departure Warning	▪	▪
Intelligent Rearview Mirror	▪	▪
High Beam Assist	▪	▪
Vehicle Dynamic Control	▪	▪
Intelligent Trace Control	▪	▪
Hill Start Assist	▪	▪
Intelligent Driver Alertness	▪	▪
<b>Safety &amp; Security</b>		
7 Airbags (Driver, Driver's Knee, Front Passenger, Side & Curtain)	▪	▪
Electronic Parking Brake with Auto Hold	▪	▪
Front & Rear Parking Sensors	▪	▪
Rear View Camera	▪	▪
Vehicle Immobiliser	▪	▪
Anti-Lock Braking System (ABS) and Electronic Brakeforce Distribution (EBD) with Brake Assist (BA)	▪	▪
Tyre Repair Kit	▪	▪

## Dimensions

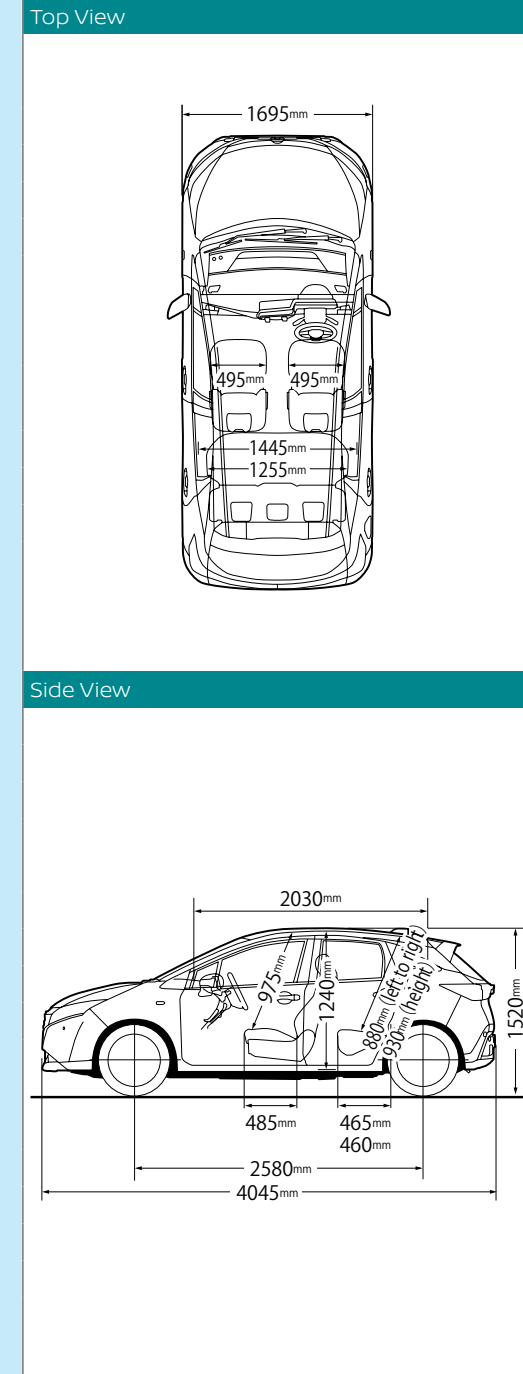

## Specifications

<b>Electric Motor</b>			
Max. Power (PS(kW)/rpm)			115(85)/2900-10341
Max. Torque (Nm/rpm)			280/0-2900
Battery Type			Lithium-ion
<b>Engine</b>			
Type			3-Cylinder 12-Valve, DOHC
Displacement	cc		1,198
Fuel Consumption	L/100km		4.6
VES Banding			A2
CO <sub>2</sub> Emission	g/km		104
Fuel Supply System			Port Fuel Injection
Fuel Type			Petrol
<b>Transmission</b>			
Type			Single Speed Reduction Gear
<b>Steering/Suspension/Brakes</b>			
Steering			Electric Power-Assisted, Rack and Pinion
Front Suspension			MacPherson Strut
Rear Suspension			Torsion Beam
Brakes System			Anti-Lock Braking System and Electronic Brakeforce Distribution with Brake Assist
Brakes (Front/Rear)			Disc/Drum
<b>Wheels/Tyres</b>			
Wheels			16-inch
Tyres			185/60 R16
Driven Wheels			Front Wheel Drive
<b>Dimensions/Weight</b>			
Overall Length	mm		4,055
Overall Width	mm		1,695
Overall Height	mm		1,520
Wheelbase	mm		2,580
Kerb Weight	kg		1,220
Min. Turning Radius	m		4.9
Min. Ground Clearance	mm		120
<b>Capacity</b>			
Seating Capacity (Incl. Driver)			5
Trunk Capacity	L		340
Fuel Tank Capacity	L		36

Tan Chong Motor Sales Pte Ltd reserves the right to make any changes without notice concerning colours, equipment and specifications detailed in this brochure, or to discontinue individual models.



Nissan Intelligent Mobility moves you one step ahead. In cars that feel like an extension of you, helping you see more and sense more, reacting with you, and sometimes even for you. Nissan Intelligent Mobility is about a better future – moving us to a world that’s safer, more sustainable and exciting.

B13B-0321-4K



Tan Chong Motor Sales

 Nissan SG  
[www.noteepower.sg](http://www.noteepower.sg)