



The Audi RS 4 Avant
Pricing and Specification Guide
Valid from March 2013

Personalising your Audi RS 4 Avant

This guide has been designed to help you tailor and price your Audi RS 4 Avant quickly and logically. At the back, you will find information on CO₂ emissions-based taxation and the other services offered by Audi, including Finance and Insurance. You can also configure your Audi RS 4 Avant online at audi.co.uk.

The Audi RS 4 Avant

Engine	12
Transmission	13
Technology	14

Model details and prices

Standard model equipment	18
Model prices	22

Audi exclusive

24

Colour and upholstery

Paint	26
Upholstery	30
Seats	33
Colour and trim guide	34

Inlays

36

Options

Wheels and tyres	42
Performance	43
Packages	44
Audio and communication	45
Interior equipment	46
Exterior equipment	47
Safety and security	48
Steering wheels and controls packs	49

Looking after your Audi

Warranty	52
Merchandise	53
Audi Difference	54

Technical details

Technical data	55
Dimensions	56
Pricing and Additional information	57





Vorsprung durch Technik

Three words that express the very essence of Audi. Vorsprung durch Technik isn't a slogan. It's our way of seeing the world. It is the driving force behind our history of innovation that continues into the 21st century. Indeed, many technologies that Audi pioneered remain in our cars today. Some are milestones in the history of the motorcar.

From our beginnings in 1899, to the Auto Union team's Grand Prix successes in the 1930s and our more recent wins at Le Mans, we have always been at the forefront of the motor industry.

Vorsprung durch Technik makes us who we are. To see more of its influence, just read on.





The latest model to wear the renowned RS badge

Since the RS 2 Avant launched back in 1994, the RS badge has been reserved for models that combine supercar performance with everyday practicality. And that's still true for the new RS 4. Available exclusively in the Avant body style, it's built around the 4.2 V8 FSI® engine. Developing 450PS, and capable of a maximum 430 Nm of torque, it means the RS 4 Avant can sprint from zero to 62mph in under five seconds on its way to a top speed of 174mph*. This formidable power is harnessed by the latest incarnation of our renowned quattro® all-wheel-drive, as well as our innovative new high-performance 18-inch Wave brake system. Simply, it's a car that provides extraordinary performance, every day.



*with the optional top speed restriction increase, where the law permits.







RS 4 Avant interior story

We've introduced a number of finishing touches to the Audi RS4 Avant interior to make your driving experience both comfortable and unique. You'll find an impressive attention to detail in everything from the luxurious leather/Alcantara seating to our optional customised stitching, which means that every journey you make will be a personal one.

Engine

Petrol

A 4.2-litre V8 FSI® engine is one innovation that sets the RS 4 Avant apart – and keeps it there. That's thanks to our Le Mans-winning fuel-injection technology, which provides enhancements to fuel efficiency, power and torque. But this unit is capable of delivering more than just raw power; it's also adept at using it. Launch Control combines both braking and acceleration to give you the quickest possible start, taking the RS 4 Avant from 0 to 62mph in just 4.7 seconds. Once you accelerate, the engine provides consistent power build-up and superb responsiveness across the entire rev range. So when you need to ask for that bit more power, whatever the situation, you can be confident it will deliver. The exhaust system with sound flap produces an unadulterated V8 sound; or for even more distinctive acoustics, there is also the option of a sports exhaust system with black tailpipe trims.



Transmission

S tronic®

Driving is all about thinking ahead, which is just what the S tronic® dual-clutch transmission does. It works almost as two separate systems, one engaging the odd-numbered and the other the even-numbered gears. So when you're accelerating in second, it has third gear waiting for you. And once you make the switch, it's already thinking about fourth. With two clutches working together, you can change gears almost instantly while experiencing smooth, uninterrupted power.

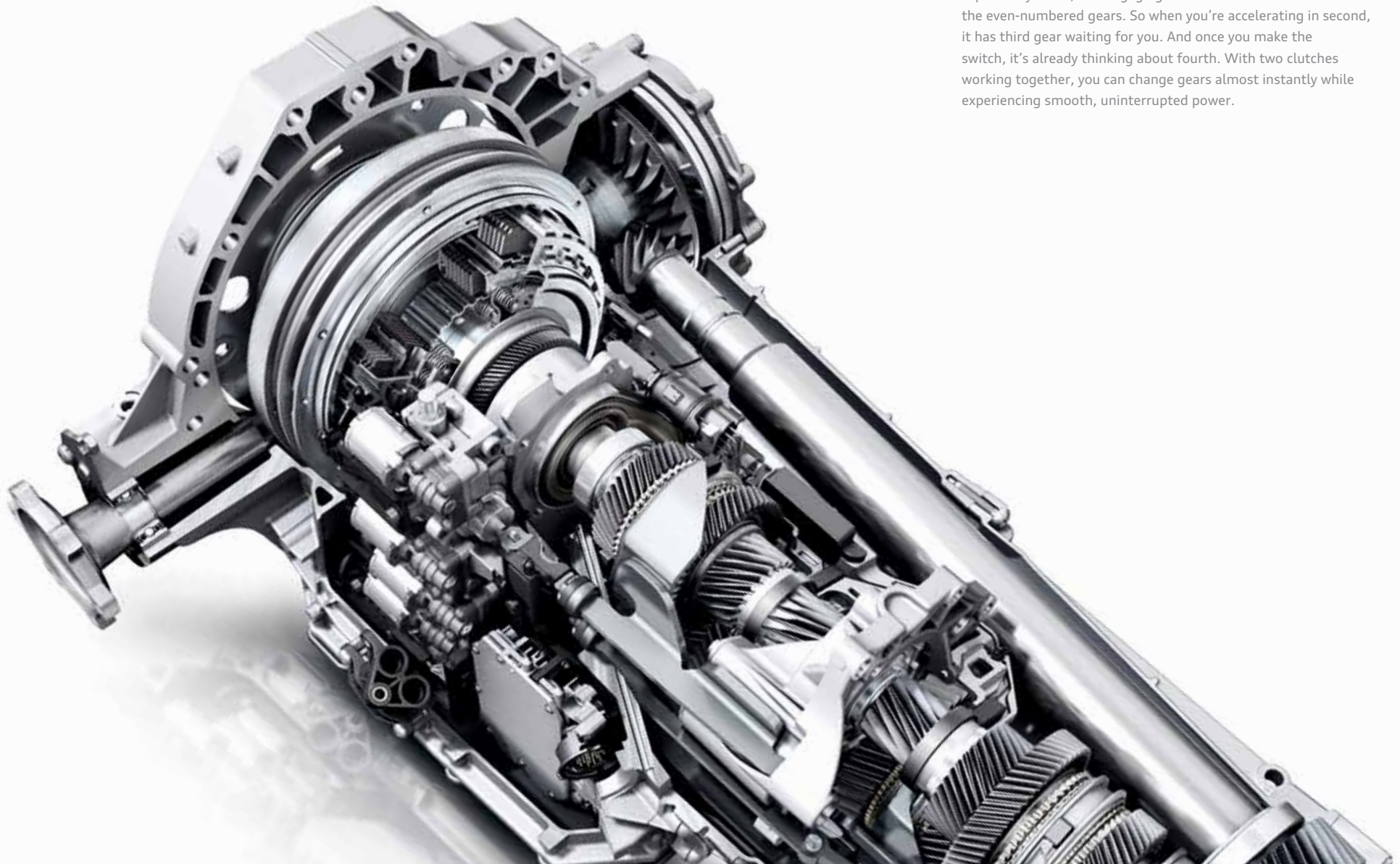

Technology

quattro® with Sports differential

The new Audi RS 4 Avant features the very latest generation of quattro® permanent all-wheel-drive – the exclusive road-holding technology that’s helped Audi to dominate the racetrack ever since 1980. Three decades and many evolutions later, it’s more compact and now features the crown-gear centre differential which is 2.5kg lighter – an addition which achieves high locking values for even greater traction. A torque vectoring function also distributes different amounts of driving force to each wheel as necessary. The result: firm traction, precision handling and high lateral stability – no matter what the road conditions.

The electronically regulated Sports differential distributes variable amounts of driving force to each rear wheel. This means outstanding acceleration performance when cornering, stabilising the vehicle’s response to load change. It also ensures better direct steering characteristics and, thanks to less steering effort, more agile handling.

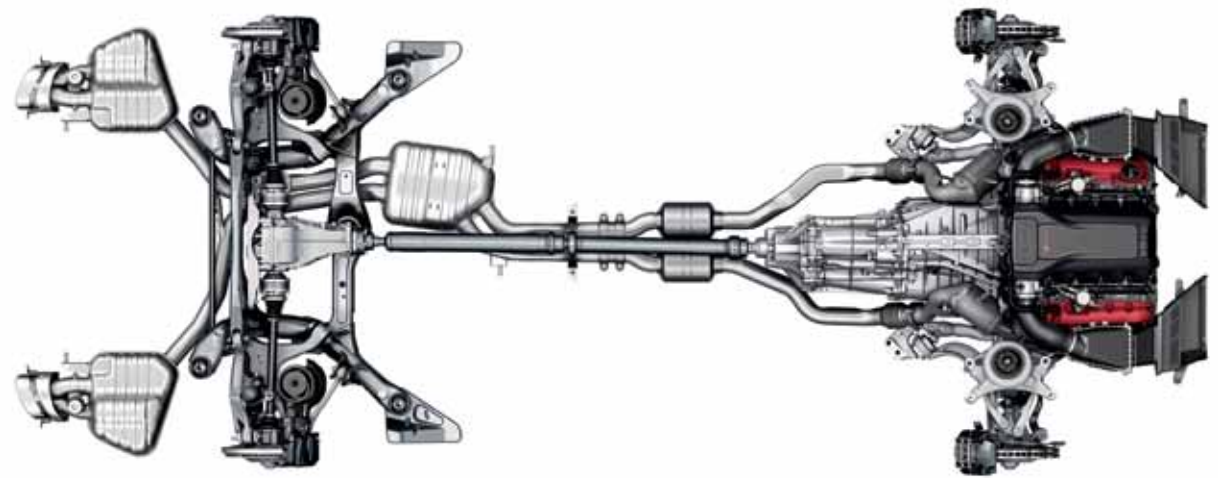



High-performance braking system

The RS 4 Avant comes with a high-performance brake system as standard. An 8-piston fixed calliper at the front combines with 365mm Wave discs to harness the formidable power of the car's 4.2-litre V8 engine. This innovative new Wave design has helped us save 3kg in weight while improving performance through better heat dissipation. Finally, there is an aluminium tandem brake booster with a ratio specific to the RS 4 Avant for added braking assistance.

For even greater stopping power, you can opt for a carbon-fibre reinforced ceramic brake system, which offers outstanding performance with virtually no fade – even under continuous load.





Standard model equipment

All RS 4 Avant models have the following items of standard equipment

The RS range incorporates some of our most exclusive, dynamic and sporty models. But in the unmistakable RS 4, you will find not only the high performance and sophistication you'd expect, but also a surprising level of practicality that makes this a great car for everyday use.

Wheels, tyres and suspension

19" x 9J '10-spoke Aero' design alloy wheels with 265/35 R19 tyres and locking wheel bolts

Audi drive select. Changes your car's handling and responses at the touch of a button to suit the way you want to drive. Enables the driver to alter the throttle response, the shift point of the automatic transmission, exhaust flap control and the power steering feel between the three pre-set modes: comfort, dynamic and auto or individual mode

Electromechanical power steering quattro® permanent all-wheel-drive with Sports differential

RS 4 Sports suspension with damper control

Tyre Mobility System

Seats

Leather/Alcantara upholstery with RS embossing in front seat backrest

Leather armrests including leather covered armrest on door panel

RS Super Sports seats, front, electrically adjustable with 4-way lumbar support and extending thigh support

Split-folding rear seats

Exterior equipment

Audi single-frame grille. Honeycomb structure in high-gloss anthracite with matt-finish aluminium-look frame

Dual-branch exhaust system with two oval tailpipe trims

Exterior mirrors – electrically operated and heated

Matt-finished aluminium-look door mirror housings, window trims and roof rails

Roof rails in matt aluminium

Roof spoiler

RS body-styling

- Front bumper with enlarged air inlets
- Rear diffuser
- Flared front and rear wheel arches
- Side sill extensions

Xenon headlights with LED daytime running lights and LED rear lights



3-spoke flat-bottomed RS steering wheel



19" x 9J '10-spoke Aero' design alloy wheels



RS instrument panel, with Piano black trim surround



Carbon inlays (MMI controls part of Satellite Navigation – HDD based)



Image shows RS 4 Avant model with optional Sepang Blue, pearl effect paint (E9) and matt aluminium styling package (VJ4)

Standard model equipment

Continued

Interior equipment

Auto-dimming rear view mirror

Aluminium-look pedals and footrest

Carbon inlays

Cruise control – maintains any speed above 18mph, provided the engine power output and engine braking effect permit it; operated via separate steering column stalk. The set speed is displayed in the Driver's Information System

3-zone climate control – with separate air distribution and digital display for the driver and front passenger. System includes air-conditioning controls in the rear centre console for passenger compartment

Door sill trims with aluminium inlays, with RS 4 logo

Driver's Information System (DIS), in colour with energy-saving tips and rest recommendations. Shows the radio station or track title, telephone control, menu and other display information from the infotainment system, such as navigation. Also includes an on-board

trip computer with short and long-term trip memory, outside temperature display, digital speedometer and door or boot-open warning

3-spoke flat-bottomed RS steering wheel, with aluminium-look shift paddles and RS 4 badge, perforated leather with contrasting stitching in Rock grey

Front centre armrest including 12V power socket

Interior light package. Includes front and rear footwell lighting, active door reflectors, illuminated vanity mirrors, rear reading lights, entrance lights and illuminated glove compartment, vents and internal door controls

RS instrument panel, with Piano black trim surround

Through-load facility – in the backrest of the centre rear seat. It provides practical and safe transport of long objects. Includes ski/snowboard bag for up to 4 pairs of skis or 2 snowboards up to 200cm in length

Audio and communication

Audi Sound System speaker package, with 10 speakers including subwoofer (180 Watts)

MMI Navigation system – DVD-based. Map is shown on the 6.5" colour centre display. Includes:

- 2 SDHC memory card readers and DVD player for navigation data. This can also be used for music CDs, MP3, WMA and AAC compatible
- Dynamic route guidance via TMC, numerous route planning options and destination memory
- 5-digit postcode entry
- Turning instructions in the Driver's Information System (DIS)
- Voice control to operate address book, radio and navigation system (destination entry via spelling)
- Europe DVD (where digitised)



Door sill trims with aluminium inlays and RS 4 logo



RS Super Sports seats



LED rear lights

Audi Music Interface – provides connection for use with stereo audio sources, USB and MP3 devices including Apple iPod generation 4 onwards and Apple iPhone. Provides intuitive control through the audio system and multi-function steering wheel. It also replicates the iPod display on the audio screen and Driver's Information System (DIS), including track titles. The interface provides a charging function (dependent on device). Includes 2 cables to connect your iPod or USB MP3 device

Bluetooth interface, for handsfree mobile phone connectivity. Includes voice control for telephone functions

Safety and security

Airbag system for driver and front passenger. Front-side and head airbags with front passenger airbag deactivation switch and Sideguard curtain airbags

Adaptive headlights with turning light – swivelling headlights for improved illumination of a winding road. Includes a turning light which is activated at speeds below 19mph and with the dipped beam switched on for better illumination of tighter corners

Audi parking system plus. Acoustic and visual parking assist system for the front and rear with MMI screen display; measured by sensors concealed in the bumpers

Rest recommendation system – analyses driving behaviour based on steering, pedals and gear lever movements. If the system detects a change in driving patterns it can notify the driver of the possible need to take a rest via audio and visual effects

Light and rain sensor – automatically switches the dipped beam headlights and windscreen wipers on/off. Also includes coming home/leaving home function which delays the deactivation of the front and rear lights after locking, and automatic activation of the lights when unlocking

Electromechanical parking brake, includes parking brake function when stationary, drive-off assistance function through automatic release when driving away and emergency braking function whilst driving, acting on all 4 wheels

Electronic Stability Control (ESC), with two-stage deactivation. In Sport mode, engine intervention for traction control is suppressed and stabilising brake intervention occurs later. In the second stage, the ESC is completely deactivated

First aid kit with warning triangle

Front and rear ISOFIX child seat preparation

Rear fog lights

Thatcham category 1 alarm

Toolkit and car jack

Tyre pressure monitoring system



Roof spoiler



Matt-finished aluminium-look door mirrors



Honeycomb structure in high-gloss anthracite with matt-finish aluminium-look frame

RS 4 Avant

Engine	Power	Transmission	CO ₂ g/km	Basic RRP	Total RRP inc VAT	Recommended OTR
4.2 FSI quattro	450PS	7-speed S tronic	249	£44,554.17	£53,465.00	£54,925.00

Please note: The maximum power output figures are quoted in PS (or Pferdestärke, which is the metric equivalent of brake horsepower). To convert to brake horsepower, divide the PS figure by 1.0139.

Recommended On-The-Road (OTR) retail prices include: delivery charge, half a tank of fuel, number plates at £590.00 (inc. VAT), Road Fund Licence (which may vary depending on model/transmission; see page 58 for details) and first registration fee at £55.00. Vehicle Excise Duty correct at time of going to print, but this may alter to reflect any change in the applicable VED rate.

RRP – Recommended Retail Price. VAT is calculated at 20% but this may alter to reflect any change in the applicable VAT rate.







Audi exclusive

Every Audi is intrinsically exclusive. It's the breathtaking design, the exceptional engineering, the Vorsprung durch Technik. But for that special touch you can specify your new RS4 Avant with options from Audi exclusive. Whether you want a unique, custom-mixed paint colour or seats in a combination of complementary shades, Audi exclusive will enable you to drive the car you've always imagined.

Both the exclusive and standard options can be found on the following pages.



Paint choices

We believe that every part of your car should have a personal touch. Which is why you can choose from a wide range of paint colours and finishes, from standard shades to metallic and pearl effects. We can even mix a customised colour for you to create the perfect fit.

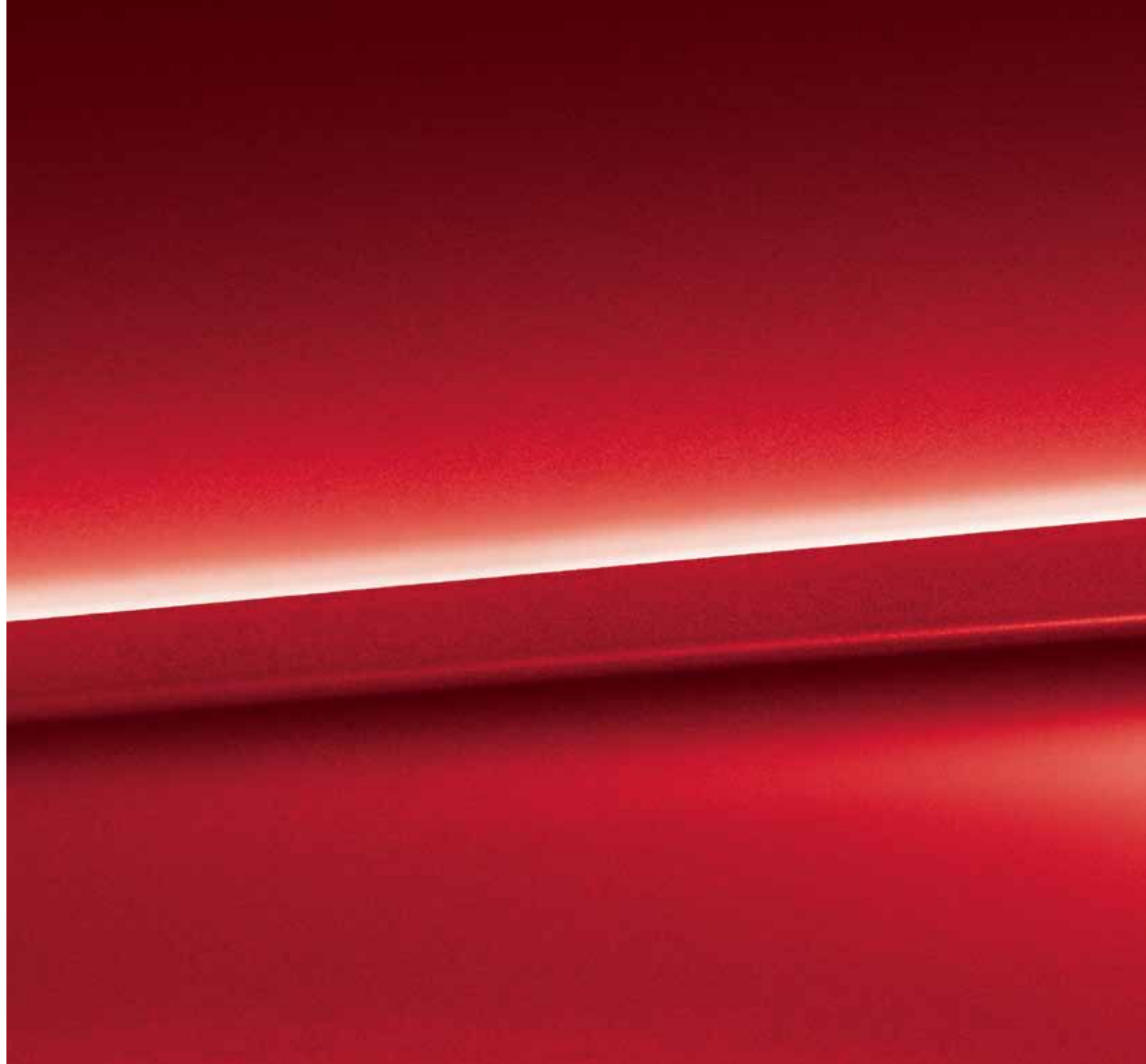

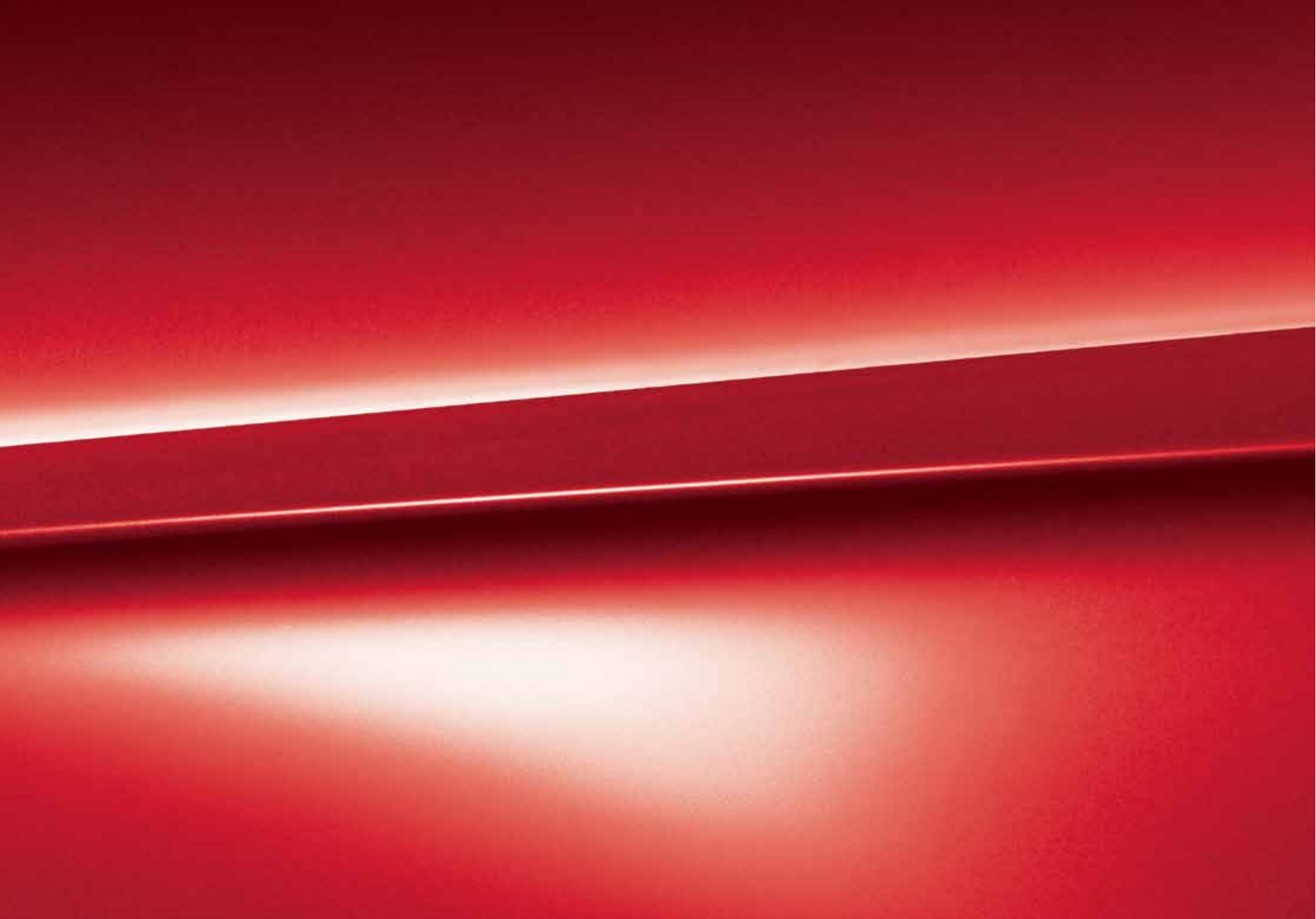

Paint

You can select the standard Ibis white shown opposite or, for a different look, choose from a range of optional finishes.

Standard colour



Ibis white – T9

Optional colours



Suzuka grey, metallic – M1

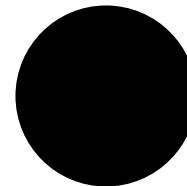

Phantom black, pearl effect – L8

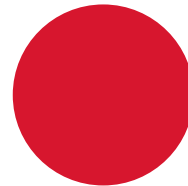

Misano red, pearl effect – N9

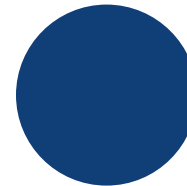

Sepang blue, pearl effect – E9

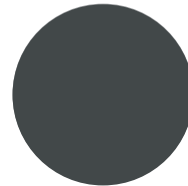

Daytona grey, pearl effect – 6Y

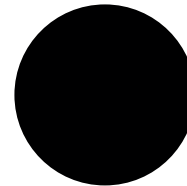

Panther black, crystal effect – H8



Prism silver, crystal effect – T0

Options are subject to availability and may extend delivery.

All the colour swatches on this page are matched as accurately as possible to the actual paint colours used. However, due to print processes, Audi UK cannot guarantee that colours shown are 100% accurate.

Visit your local Audi Centre for a more accurate colour swatch.

RRP – Recommended Retail Price.

VAT is calculated at 20% but this may alter to reflect any change in the applicable VAT rate.

Optional colours

Basic RRP
£512.50

Total RRP inc VAT
£615.00

Panther black and Prism silver

Basic RRP
£720.83

Total RRP inc VAT
£865.00

Paint

Audi exclusive

Everyone has a favourite colour. No matter what yours is, Audi exclusive provides a range of unique colours that have been designed to set your car apart. Choose from the swatches here, or specify any other paint colour in the Audi range – whether it's Jet blue from the Audi R8 or Alpine white from the original Audi quattro. The choice is yours.

Customised

If you have a particular colour in mind, we'll mix the exact metallic or pearl-effect shade you want.*

Options are subject to availability and may extend delivery.

*Custom paint is subject to factory approval, and is available for metallic and pearl-effect water-based paints only. Three-colour process colours and two-tone schemes are not available.

**Visit your local Audi Centre for colour samples

All the colour swatches on this page are matched as accurately as possible to the actual paint colours used. However, due to print processes, Audi UK cannot guarantee that colours shown are 100% accurate.

RRP – Recommended Retail Price.

VAT is calculated at 20% but this may alter to reflect any change in the applicable VAT rate.



Palace blue, pearl effect

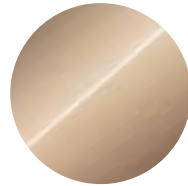

Sand beige, pearl effect

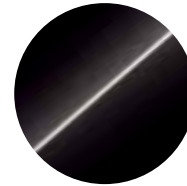

Saddle brown, pearl effect

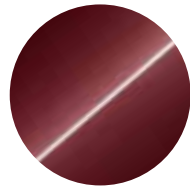

Classic red, pearl effect

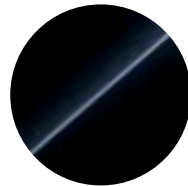

Mamba black, metallic

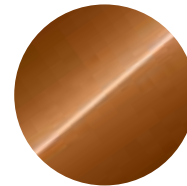

Ipanema brown, metallic



Any colour in the Audi range or 100 exclusive colours to choose from**



Customised paint

Audi exclusive

Basic RRP
£1,762.50

Total RRP inc VAT
£2,115.00

Customised*

Basic RRP
£2,179.17

Total RRP inc VAT
£2,615.00

Upholstery

It's important to feel comfortable on the road. Just choose from our range of luxury upholstery materials and textures, including additional support and colour options, for complete relaxation while you drive.





Upholstery

RS 4 front Super Sports seats

With pronounced side sections, integral headrests and embossed RS 4 logo in the backrest. Front seats are electrically adjustable with 4-way lumbar support and extending thigh support. All upholstery options include head restraints, seat side bolsters, front and rear door armrest and front centre armrest in leather. Seat centre and door inserts are in Alcantara or Fine Nappa Leather depending on your upholstery choice.

RS 4 front bucket seats



With more pronounced seat contours to give increased lateral support for sporty driving. Heated, with electric lumbar support and width adjustment for seat cushion and backrest. Manual forwards/backwards, seat height and backrest adjustment.

Options are subject to availability and may extend delivery.

- = Not available
- = Available
- S = Standard

RRP – Recommended Retail Price.

VAT is calculated at 20% but this may alter to reflect any change in the applicable VAT rate.

	RS 4 Avant	Basic RRP	Total RRP inc VAT
Leather/Alcantara  Black – QH/SX	S	No charge	No charge
Fine Nappa leather   Black with Rock grey piping* – UB/QI Lunar silver with Rock grey piping* – QO/SO	•	£333.33	£400.00
Fine Nappa leather  Black metallic with Rock grey stitching – UB/QI	•	£1,804.17	£2,135.00

*Upholstery with Rock grey piping also includes steering wheel and gear-shift gaiter in Rock grey stitching.

Seats

Choose from a variety of different seat options so you can maintain the right driving posture at all times.

Order Code		RS 4 Avant	Basic RRP	Total RRP inc VAT
4A3	Heated front seats. Heats the seat cushions and backrest surfaces and can be adjusted in 3 stages for each individual seat via a direct selection button on the air conditioning controls. In combination with leather upholstery, the seat side bolsters are also heated	●	£250.00	£300.00
4A4	Heated front and outer rear seats. Individually controlled variable temperature adjustment In combination with RS 4 front bucket seats	●	£383.33	£460.00
		●	£150.00	£180.00
PV3 6XL	Convenience package. With memory function for driver's side and folding, auto-dimming door mirrors with memory function. Two different positions can be stored, adapting seats' longitudinal position, height, inclination and backrest angle, as well as the exterior mirror settings. The positions are assigned to the corresponding car key, and the system automatically adopts the relevant settings when the car is unlocked via the remote control. Mirrors also include curb view function which lowers the passenger side mirror for increased visibility whilst reversing	●	£375.00	£450.00
PS5 N1T 4A3	RS 4 front bucket seats in Fine Nappa leather. With more pronounced seat contours to give increased lateral support for sporty driving. Heated, with electric lumbar support and width adjustment for seat cushion and backrest. Manual forwards/backwards, seat height and backrest adjustment. This option deletes front side airbags, passenger airbag disconnect and ISOFIX preparation for front passenger seat. Not available in combination with convenience package, storage package, electric front seats or through-load facility	●	£1,804.17	£2,135.00



Standard front Super Sports seats



Optional front bucket seats (PS5)

Options are subject to availability and may extend delivery.

– = Not available

● = Available

S = Standard

RRP – Recommended Retail Price.

VAT is calculated at 20% but this may alter to reflect any change in the applicable VAT rate.

Colour and trim guide

Interior trim colours

RS 4 front Super Sports seats

Use this guide to help you choose the right interior for your Audi RS 4 Avant. It shows the carpet, dashboard and headlining colours that have been matched to your chosen upholstery.

Order code	Upholstery	Carpet	Dashboard	Headlining	Leather/Alcantara (N7S)	Fine Nappa leather (N5V)
QH	Black	Black	Black	Black	●	—
SX	Black	Black	Black	Lunar silver	●	—
UB	Black with Rock grey piping	Black	Black	Black	—	●
QI	Black with Rock grey piping	Black	Black	Lunar silver	—	●
QO	Lunar silver with Rock grey piping	Black	Black	Black	—	●
SO	Lunar silver with Rock grey piping	Black	Black	Lunar silver	—	●

RS 4 front bucket seats (PS5, N1T, 4A3)

Order code	Upholstery	Carpet	Dashboard	Headlining	Fine Nappa leather (N1T)
UB	Black metallic with Rock grey stitching	Black	Black	Black	●
QI	Black metallic with Rock grey stitching	Black	Black	Silver	●

Options are subject to availability and may extend delivery.

— = Not available
 ● = Available
 S = Standard

Upholstery

Audi exclusive

With Audi exclusive, you can specify your seats in Valcona leather or Valcona leather/Alcantara, in an array of different colours shown to the right.

Select just one all-over shade for each seat, or customise each panel in two or more complementary colours from the distinctive Audi exclusive palette. You can even choose the colour of the decorative stitching – to match or contrast with your chosen upholstery – from this varied collection. Whatever combination you decide upon, we think you'll be extremely comfortable with the result.

Options are subject to availability and may extend delivery.

– = Not available
• = Available
S = Standard

*Leather and stitching (where applicable) can be specified in a variety of colours from the Audi exclusive range.

RRP – Recommended Retail Price.

VAT is calculated at 20% but this may alter to reflect any change in the applicable VAT rate.

Order Code		RS 4 Avant	Basic RRP	Total RRP inc VAT
PYC S3G	Audi exclusive leather package 1 in Valcona leather/Alcantara. Seat side sections, head restraints, front centre armrest and door armrest in Valcona leather with RS 4 embossing in front seat backrest. Front and rear seat centre section and door trim inserts in Alcantara*	•	£3,191.67	£3,830.00
PYB S3G	Audi exclusive leather package 1 in Valcona leather. Front and rear seat upholstery, head restraints, door trim inserts, front centre armrest and door armrests in Valcona leather, with RS 4 embossing in front seat backrest*	•	£3,191.67	£3,830.00
PYE S3G	Audi exclusive leather package 2 in Valcona leather. Includes all the contents of leather package 1 (PYB/S3G) plus leather-covered seat backrest covers. Seat-side trims and add-on parts are colour-coordinated*	•	£3,616.67	£4,340.00
PYO S3G	Audi exclusive design package: RS 4 bucket seats in Black quilted Valcona leather with diamond design and red stitching. Seat upholstery, head restraints, door trim inserts, front centre armrest and door armrests in black Valcona leather with RS 4 logo embossed in the front seat backrests. Crimson red stitching to door armrests and controls, and includes black floor mats with Crimson red leather piping. Please see image on page 24*	•	£5,783.33	£6,940.00
PYI S3G	RS 4 bucket seats with Audi exclusive quilted Valcona leather with diamond design. Seat upholstery, head restraints, door trim inserts, front centre armrest and door armrests in Valcona leather with RS 4 logo embossed in the seatbacks of the front seats. Includes stitching to door armrests and controls*	•	£5,783.33	£6,940.00



Chestnut brown



Jet grey



Alabaster white

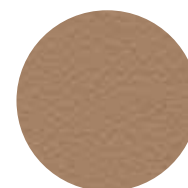

Sand beige

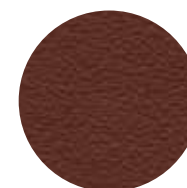

Saddle brown

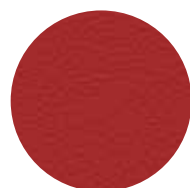

Crimson red



Magnolia white



Havanna brown

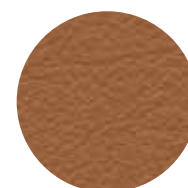

Cognac brown



Night blue

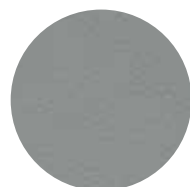

Cloudy grey

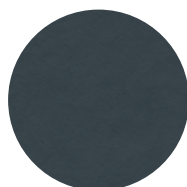

Smoky blue

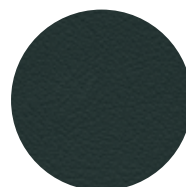

Iceland green



Powder beige



Classic red

Also available:

Alcantara colours: available in all the Audi exclusive colours shown, except for Crimson red, Jet grey and Sand beige. Alcantara equivalents are Chilli red, Amethyst grey, and Sesame beige respectively.

Carpet colours: available in all the Audi exclusive colours shown.

Please consult your Audi Centre for examples of Alcantara and carpet colours.

Inlays

Attention to detail can make a big impact. From contemporary black Piano finish to stainless steel mesh, our selection of inlays make the perfect finishing touch to your car's interior.





Inlays

Inlays are the all-important finishing touch that add flair and interest to your car's interior.

Order Code		RS 4 Avant	Basic RRP	Total RRP inc VAT
5MB	Carbon	S	No charge	No charge
5TG	Matt-brushed aluminium	•	No charge	No charge
5TL	Piano finish, black	•	No charge	No charge
5MD	Aluminium Race	•	No charge	No charge
5MZ	Stainless steel mesh (centre console in Piano black)	•	No charge	No charge

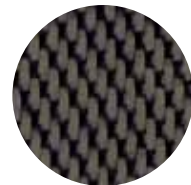

Carbon – **5MB**

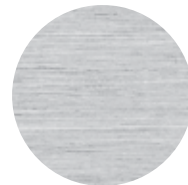

Matt-brushed aluminium – **5TG**

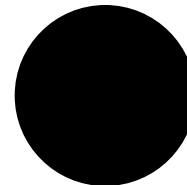

Piano finish, black – **5TL**

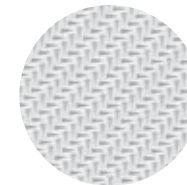

Aluminium Race – **5MD**

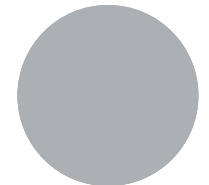

Stainless steel mesh – **5MZ**

Options are subject to availability and may extend delivery.

- = Not available
- = Available
- S = Standard

RRP – Recommended Retail Price.

VAT is calculated at 20% but this may alter to reflect any change in the applicable VAT rate.

Inlays

Audi exclusive

Audi exclusive has sourced a varied range of materials from which to craft these elements. You can even customise your gear knob and steering wheel with one of the available woods.

Order Code		RS 4 Avant	Basic RRP	Total RRP inc VAT
YTA S3G 5TG	Audi exclusive inlays	●	£675.00	£810.00



Fine grain ash, nougat



Quilted maple, gold



Oak, sepia

Options are subject to availability and may extend delivery.

- = Not available
- = Available
- S = Standard

RRP - Recommended Retail Price.

VAT is calculated at 20% but this may alter to reflect any change in the applicable VAT rate.

Options

Every driver has different needs, which is why we have created some useful options to further enhance your car. For extra comfort, support, style or function, you can choose from a variety of additional features, tailoring everything from your infotainment and audio equipment to your wheels and lighting.



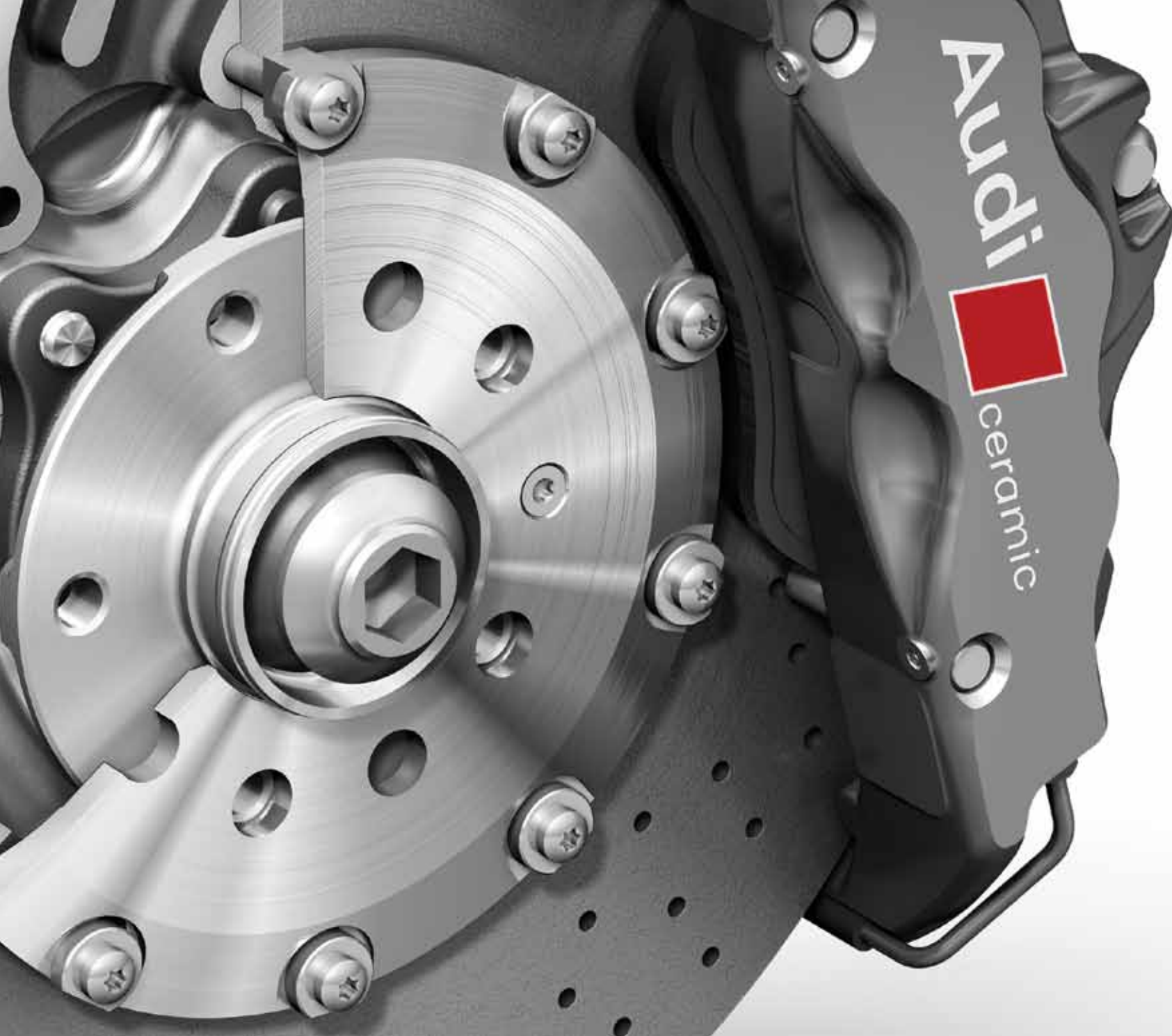

Wheels and tyres

Choose a set of specially-selected alloy wheels to subtly enhance the way your car looks and drives.

Order Code		RS 4 Avant	Basic RRP	Total RRP inc VAT
C5H	19" x 9J '10-spoke' design alloy wheels with 265/35 R19 tyres	S	No charge	No charge
PQW	20" x 9J '5-arm Rotor' design Aluminium look alloy wheels with 265/30 R20 tyres	●	£1,041.67	£1,250.00
PQ3	20" x 9J '5-arm Rotor' design Titanium look alloy wheels with 265/30 R20 tyres	●	£1,125.00	£1,350.00
PQI	20 x 9J '5 V-spoke' design polished Titanium alloy wheels with 265/30 R20 tyres	●	£1,125.00	£1,350.00



19" x 9J '10-spoke' design alloy wheels – C5H



20" x 9J '5-arm Rotor' design Aluminium look alloy wheels – PQW



20" x 9J '5-arm Rotor' design Titanium look alloy wheels – PQ3



20" x 9J '5 V-spoke' design polished Titanium alloy wheels – PQI

Options are subject to availability and may extend delivery.

- = Not available
- = Available
- S = Standard

RRP – Recommended Retail Price.

VAT is calculated at 20% but this may alter to reflect any change in the applicable VAT rate.

Performance

We've developed a whole range of performance options to complement the capabilities of the RS 4 Avant – everything from an increased top speed to a high performance brake system.

Options are subject to availability and may extend delivery.

*Where the law permits

- = Not available
- = Available
- S = Standard

RRP – Recommended Retail Price.

VAT is calculated at 20% but this may alter to reflect any change in the applicable VAT rate.

Order Code		RS 4 Avant	Basic RRP	Total RRP inc VAT
NM5	Design package in Carbon for engine bay	●	£366.67	£440.00
1LW	Ceramic brakes – front. High performance brake system with carbon-fibre reinforced, vented and perforated ceramic brake discs. Brake callipers in 'Anthracite' with 'Audi ceramic' logo on front. Benefits include extremely high level of wear resistance and enhanced fading resistance due to a lower sensitivity to high thermal loads. Also benefits from lower (unsprung) weight compared with steel brake discs	●	£3,333.33	£4,000.00
0P6	Sports exhaust which further enhances the engine sound of the RS 4 Avant, with black tailpipe trims	●	£741.67	£890.00
6Y9	Top speed restriction increase to 174mph*	●	£1,083.33	£1,300.00
2MC	Sports suspension plus with Dynamic ride control (DRC). Enhanced suspension setup which consists of a special shock absorber system that counteracts pitch and body roll movements without using any electronic devices. With DRC, diagonally opposed shock absorbers on the car are linked together hydraulically. A central valve varies the shock absorber operating characteristic, for instance when the steering wheel is turned and the car is cornered, so that movement around the longitudinal axis (roll) is significantly reduced. DRC uses the same principle to counteract body movement around the transverse axis (pitch) when the car is accelerated or braked. There is a choice of 3 settings; comfort, dynamic or auto. Also available as part of the Sports package (WC9)	●	£1,425.00	£1,710.00
1N8	Dynamic steering. Improves comfort and handling by dynamically regulating steering according to the driving situation. Allows the steering feel to be adapted to road speed and the chosen Audi drive select mode. With this technology, driving is significantly more agile under everyday conditions, while directional stability and precision are increased at high speeds and in demanding driving situations. Also enhances active safety with corrective steering inputs if critical situations are detected. Also available as part of Sports package (WC9)	●	£312.50	£375.00



Sports exhaust. Oval shaped dual exhaust pipes in matt black



Carbon design package for engine bay



Ceramic brakes – front

Packages

Some items work well together, which is why we've created these special packages. They provide increased convenience and value by combining several of our most popular options.

Order Code	RS 4 Avant	Basic RRP	Total RRP inc VAT
<p>Sports package</p> <p>20" '5-arm Rotor' design alloy wheels in Aluminium look or Titanium look finish</p> <p>Sports suspension plus with Dynamic Ride Control (DRC). Enhanced suspension setup which consists of a special shock absorber system that counteracts pitch and body roll movements without using any electronic devices. With DRC, diagonally opposed shock absorbers on the car are linked together hydraulically. A central valve varies the shock absorber operating characteristic, for instance when the steering wheel is turned and the car is cornered, so that movement around the longitudinal axis (roll) is significantly reduced. DRC uses the same principle to counteract body movement around the transverse axis (pitch) when the car accelerates or brakes. There is a choice of 3 settings: comfort, dynamic or auto</p> <p>Dynamic steering. Improves comfort and handling by dynamically regulating steering according to the driving situation. Allows the steering feel to be adapted to road speed and the chosen Audi drive select mode. With this technology, driving is significantly more agile under everyday conditions, while directional stability and precision are increased at high speeds and in demanding driving situations. Also enhances active safety with corrective steering inputs if critical situations are detected</p> <p>Sports exhaust. Further enhances the engine sound of the RS 4 Avant, with black tailpipe trims</p>	●	£1,875.00	£2,250.00
<p>Sound package</p> <p>Bang & Olufsen sound system. Features 14 high-performance speakers and two amplifiers which create 505 Watts of stunning surround sound, balanced to suit the specific acoustic properties of the car's interior. The system constantly and automatically adapts the sound characteristics to the vehicle's speed and background noise, providing the highest level of quality. The digital signal-processing amplifier takes output from standard stereo sources such as CD players, iPods or DAB radios and creates exceptional five-channel surround sound</p> <p>DAB digital radio. Receives programmes from digital radio transmitters in addition to the range of analogue stations, with better sound quality. A second DAB twin tuner permanently searches for alternative reception frequencies of the set station, and the station list is updated at the same time. Please note – reception depends on local digital network availability. When combined with HDD Navigation (PNQ), it is also capable of receiving DAB+ and DMB audio signals</p>	●	£500.00	£600.00
<p>Technology package – Advanced</p> <p>Satellite Navigation with MMI 3G – HDD-based. Hard disk navigation with topographical map displays places of interest and town models in 3D, with high-resolution 7" colour TFT display. The system offers three alternative routes, with the ability to scroll along the selected route and manoeuvre within the map. Uses 7-digit postcode recognition. Includes split-screen mode for route information, dynamic route guidance (TMC), intersection zoom function, motorway exits and lane recommendations in Driver's Information System (DIS).</p> <p>When combined with Mobile telephone preparation – High with Audi connect (9ZW), the system uses Google Earth images for navigation. Includes 2 SD card readers, single CD/DVD player and 40GB hard drive, Jukebox (20GB) for storing and managing music files in WMA and MP3 format. Includes European navigation data (where digitised)</p> <p>Adaptive cruise control with braking guard. Intelligent automatic speed and distance control system. Works at speeds from 19-124mph, using radar sensors to measure and maintain required distance to vehicle ahead by braking and accelerating. Includes Audi braking guard – a system which triggers a visual and acoustic alarm when it detects the risk of a rear end collision with the vehicle in front.</p> <p>Audi parking system advanced. Aids parking by acoustically and visually indicating distances to obstacles with guiding lines.</p> <p>Audi active lane assist. Helps the driver to stay in lane with gentle steering impulses for greater safety and convenience, particularly on motorways and country roads</p>	●	£1,183.33	£1,420.00

Options are subject to availability and may extend delivery.

- = Not available
- = Available
- S = Standard

RRP – Recommended Retail Price.

VAT is calculated at 20% but this may alter to reflect any change in the applicable VAT rate.

Audio and communication

Stay in touch using our range of communication functions, and give each journey its own soundtrack with our advanced audio equipment.

Order Code		RS 4 Avant	Basic RRP	Total RRP inc VAT
QV3	DAB digital radio. Receives programmes from digital and analogue radio transmitters with better sound quality. A second DAB twin tuner permanently searches for alternative reception frequencies of the set station, and the station list is updated at the same time. When combined with HDD Navigation (PNQ), it is also capable of receiving DAB+ and DMB audio signals. Reception depends on local digital network availability. Also available as part of the Sound package (WB3)	●	£254.17	£305.00
9VK	Bang & Olufsen sound system. Featuring 14 high-performance speakers and two amplifiers which create 505 Watts of stunning surround sound, balanced to suit the specific acoustic properties of the car's interior. The system constantly and automatically adapts the sound characteristics to the vehicle's speed and background noise, for the best quality output. The digital signal-processing amplifier takes output from standard stereo sources such as CD players, iPods or DAB radios and creates exceptional five-channel surround sound. Also available as part of the Sound package (WB3)	●	£445.83	£535.00
7A6	CD changer. For 6 CDs, located in the glove box. Operated via MMI system. Not in combination with HDD Navigation (PNQ) or Technology package - Advanced (PCB)	●	£254.17	£305.00
7D1	CD changer and DVD player. For 6 CDs, located in the glove box. Operated via MMI system. Only in combination with HDD Navigation (PNQ) or Technology package - Advanced (PCB)	●	£254.17	£305.00
PNQ 7QA	Satellite Navigation with MMI 3G – HDD-based. Hard disk navigation with topographical map displays places of interest and town models in 3D, with high-resolution 7" colour TFT display. The system offers three alternative routes, with the ability to move along the selected route and manoeuvre within the map. Uses 7-digit postcode recognition. Includes split-screen mode for route information, dynamic route guidance (TMC), intersection zoom function, motorway exits and lane recommendations in Driver's Information System (DIS). When combined with Mobile telephone preparation – High, with Audi connect (9ZW), the system uses Google Earth images for navigation. Includes 2 SD card readers, single CD/DVD player and 40GB hard drive and Jukebox (20GB) for storing and managing music files in WMA and MP3 format. Includes European navigation data (where digitised). Also available as part of Technology package – Advanced (PCB)	●	£391.67	£470.00
9ZW	Mobile telephone preparation – High, with Audi connect. A mobile phone can be connected to the internal UMTS (3G) module via Bluetooth (provided the mobile telephone has SIM Access Profile ¹), or alternatively through the additional SIM card reader ² . It is possible to transfer phone book entries to the car and manage call lists. Audi connect features include: navigation using Google Earth images and Google Street View, destination entry via Google Maps or myAudi, online point-of-interest search and information services such as weather forecasts and the latest world news. Audi connect also includes Audi traffic information online, which gives accurate real-time forecasts of the traffic situation along the chosen route. The traffic situation can be displayed on the navigation map or Google Earth image. Audi connect can also create a Wi-Fi hotspot in the car for convenient internet access using a mobile device (e.g. laptop or tablet) ³ . Many Audi connect features can be simply operated via the MMI Navigation Plus, the multi-function steering wheel or the voice control system. Only in combination with HDD Navigation (PNQ) or Technology package – Advanced (PCB)	●	£291.67	£350.00
QU7	Digital TV reception. Receives digital (DVB-T) uncoded television stations (MPEG-2 standard), TV picture, teletext and Electronic Programme Guide (EPG). Facility to connect 2 external AV sources via adaptor cables (available from Audi Genuine Accessories). TV reception depends on local digital network availability. No AV or TV video output when driving (audio output available when driving). Only available in combination with HDD Navigation (PNQ) or Technology package – Advanced (PCB)	●	£687.50	£825.00

Options are subject to availability and may extend delivery.

- = Not available
- = Available
- S = Standard

¹To check the compatibility of your mobile phone and whether it has SIM Access Profile compatibility, please visit www.audi.co.uk/owners-area/phone-compatibility.html

²Please note that when a data SIM card is inserted into the SIM card reader, Bluetooth hands-free connectivity is disabled, as the SIM card takes priority over the Bluetooth connection.

³Online services are only available for mobile phone contracts including a data option and only within the coverage of the mobile phone network; there may be additional costs for the use of these services (charges and billing correspond to the personal mobile phone contract). Due to high data volumes, a mobile phone contract including an unlimited data plan is strongly recommended. The content and scope of the online-based services offered may vary.

RRP – Recommended Retail Price.

VAT is calculated at 20% but this may alter to reflect any change in the applicable VAT rate.

Interior equipment

Specify every detail of your car's interior with this range of exclusive options.

Options are subject to availability and may extend delivery.

-- = Not available
• = Available
S = Standard

*HomeLink® is a registered trademark of Johnson Controls. For information on compatibility, visit www.homelink.com

**The leather, stitching, seat belts and leather piping (where applicable) can be selected from any of the Audi exclusive colours shown on page 35. The carpet colour can also be selected from any of the Audi exclusive colours shown on page 35.

RRP – Recommended Retail Price.

VAT is calculated at 20% but this may alter to reflect any change in the applicable VAT rate.

Order Code		RS 4 Avant	Basic RRP	Total RRP inc VAT
4F2	Advanced key. Access and authorisation system which automatically exchanges data between key and vehicle, allowing the driver to keep the key in their pocket or bag at all times. To unlock and open, simply lift the exterior door handle. To lock, press the button on the handle. Pressing the start/stop button integrated in the centre console starts and stops the engine	•	£391.67	£470.00
8T4	Adaptive cruise control with braking guard. Intelligent automatic speed and distance control system. Works at speeds from 19 – 124mph, using radar sensors to measure and maintain required distance to vehicle ahead by braking and accelerating. Four programs (distance 1 to distance 4) set via steering column controls of the cruise control system. Includes Audi braking guard – a system which triggers a visual and acoustic alarm when it detects the risk of a rear end collision with the vehicle in front. At speeds below 19mph the system can initiate partial braking or full deceleration if a potential impact is detected or if it is not possible to completely prevent a collision, the system will focus on reducing the speed at which the vehicles collide. Also available as part of Technology package – Advanced (PCB)	•	£750.00	£900.00
3GN	Load area fixing kit. Includes load-area rails, telescopic bar and securing belt for dividing up luggage compartment	•	£129.17	£155.00
6SJ	Reversible load floor mat. Luggage compartment floor mat can be reversed to provide a rubber mat which extends to protect the rear bumper	•	£70.83	£85.00
3Y4	Side window blinds – manual	•	£83.83	£100.00
QE1	Storage package. Comprising storage nets on front seat backrests, storage compartment under the front seats (in combination with Convenience package, only under the front passenger seat), drinks holder in the rear centre armrest and a lockable glove compartment	•	£83.33	£100.00
VC1	Garage door opener (HomeLink®)** programmable radio operated remote control for compatible doors/gates, control buttons integrated in the roof module at the front	•	£150.00	£180.00
YSR S3G	Audi exclusive floor mats with leather piping**. Includes 4 floor mats for front and rear (cannot be combined with optional YSQ/S3G – Audi exclusive carpets)	•	£254.17	£305.00
YSQ S3G	Audi exclusive carpets**. Includes 4 Audi exclusive floor mats with leather piping (cannot be combined with option YSR/S3G – Audi exclusive floor mats)	•	£750.00	£900.00



Exterior equipment

Make sure your car looks exactly as you want it to, by selecting some of our striking options.

Options are subject to availability and may extend delivery.

- = Not available
- = Available
- S = Standard

RRP – Recommended Retail Price.

VAT is calculated at 20% but this may alter to reflect any change in the applicable VAT rate.

Order Code		RS 4 Avant	Basic RRP	Total RRP inc VAT
4ZD	Black styling package – Radiator grille frame in highly polished black, with radiator grille number plate holder and roof rails in matt black. Not available in combination with matt aluminium styling package (VJ4)	•	£304.17	£365.00
VJ4	Matt aluminium styling package – front lip spoiler and bottom edge of rear diffuser in matt aluminium. Not available in combination with black styling package (4ZD)	•	£400.00	£480.00
2Z0	Deletion of model and engine technology designation at rear	•	No charge	No charge
6XK	Door mirrors – electrically folding, heated and auto dimming	•	£241.67	£290.00
8N7	High-beam assist. Variable headlight range control, featuring a camera on the interior mirror which registers sources of light from other road users. The range and width of the headlight beam is continuously varied between dipped and main beam to suit ambient conditions, ensuring that the headlights provide good visibility without dazzling other road users	•	£91.67	£110.00
4E9	Power-operated tailgate. Opened by pressing button on the car key, button in the driver's door panel or soft-touch button in the handle recess on the luggage compartment lid. Closed by pressing a button on the inside of the luggage compartment lid. The opening of the luggage compartment lid can be programmed to desired height	•	£183.33	£220.00
VW1	Privacy glass. Dark tinted rear window, rear door windows and rear side windows	•	£275.00	£330.00
3FU	Open sky panoramic sunroof. Comprising glass roof with electric slide and tilt control and sunshade at front and rear	•	£937.50	£1,125.00



Black styling package and Privacy glass



Matt aluminium styling package



Open sky panoramic sunroof

Safety and security

Intelligent technology designed to give you better all-round awareness and safety on the road.

Options are subject to availability and may extend delivery.

- = Not available
- = Available
- S = Standard

RRP - Recommended Retail Price.

VAT is calculated at 20% but this may alter to reflect any change in the applicable VAT rate.

Order Code		RS 4 Avant	Basic RRP	Total RRP inc VAT
7X8	Audi parking system advanced , aids parking by acoustically and visually indicating distances to obstacles in front of and behind your RS 4. Measured by ultrasonic sensors and camera integrated discreetly in the boot handle. Also available as part of Technology package - Advanced (PCB)	•	£283.33	£340.00
UH2	Audi hill-hold assist - Holds the vehicle stationary on both uphill and downhill gradients allowing the driver to move away smoothly and comfortably without having to operate the electromechanical parking brake	•	£54.17	£65.00
7Y1	Audi side assist . Aids the driver when changing lane. Audi side assist monitors the area behind your car using radar sensors located discreetly in the rear bumper. It informs the driver with a visual warning signal in the door mirror if there is a vehicle in their blind spot or approaching quickly from behind. The system is activated using a button in the driver's door	•	£366.67	£440.00
7Y4	Audi active lane assist . Helps the driver to stay in lane with gentle steering impulses for greater safety and convenience, particularly on motorways and country roads. The system informs the driver if the car is drifting out of its lane unintentionally above approximately 37mph. The driver has the choice of two system settings in the MMI: Early steering intervention - continuously helps the driver to stay in lane with steering impulses that centre the vehicle in its lane Late steering intervention - alerts the driver that the vehicle is possibly crossing the lane markings at the same time as providing a corrective steering prompt An additional warning in the form of vibrating steering wheel is issued when lane markings are crossed, if specified by driver. Also available as part of Technology package - Advanced (PCB)	•	£308.33	£370.00
4X4	Rear side airbags . For the outer rear seats, incorporated into the seat backrests. These supplement both the side impact protection in the doors and the head airbag system	•	£212.50	£255.00

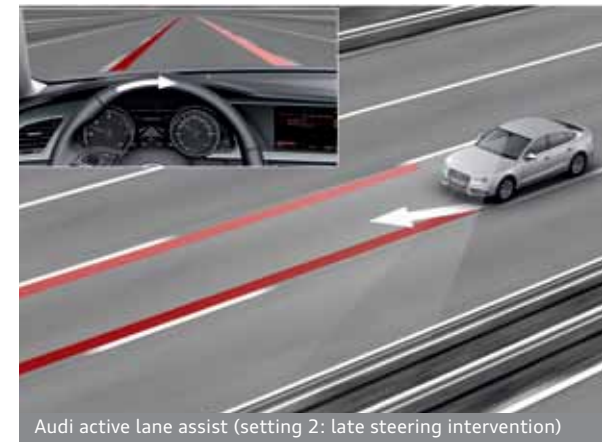
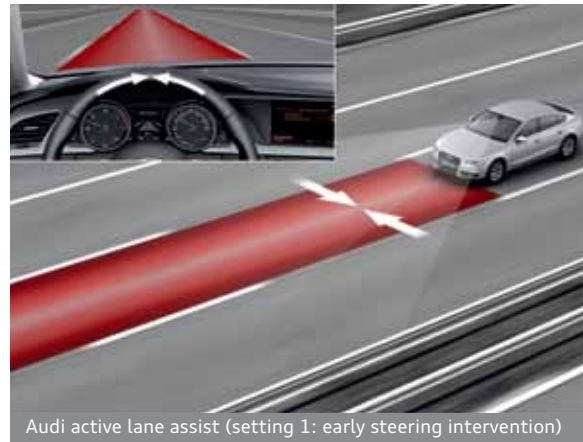
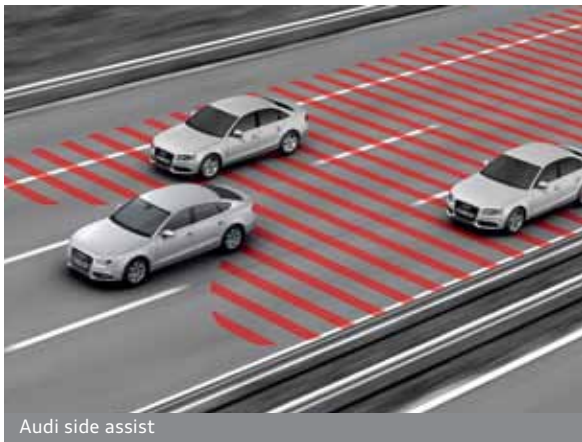

Steering wheels and controls packs

Audi exclusive

With Audi exclusive, you can choose a luxurious leather steering wheel or controls pack in a choice of colours from the Audi exclusive range.

The leather, stitching and leather piping (where applicable) can be selected from any of the Audi exclusive colours shown on page 35.

Options are subject to availability and may extend delivery.

- = Not available
- = Available
- S = Standard

RRP – Recommended Retail Price.

VAT is calculated at 20% but this may alter to reflect any change in the applicable VAT rate.

Order Code		RS 4 Avant	Basic RRP	Total RRP inc VAT
YRH S3G	Audi exclusive leather-covered steering wheel	•	£304.17	£365.00
YRB S3G	Audi exclusive controls package – includes leather-covered steering wheel, gear selector and gear selector gaiter	•	£512.50	£615.00
YUC S3G	Audi exclusive controls package in black suede – includes steering wheel rim and gear selector in black suede	•	£629.17	£755.00



Looking after your Audi

When you've chosen your ideal model, it's reassuring to know that it will remain in safe hands. That's why we've created products to protect your Audi, from extended warranties to Audi Complete – our comprehensive service and maintenance package. And there's also a range of Audi accessories and merchandise to choose from, enabling you to further enhance and safeguard your car.





Warranty

Order Code		RS 4 Avant	Basic RRP	Total RRP inc VAT
-	Audi Warranty , covering you for unlimited mileage in the first two years of ownership, and up to 60,000 miles in the third year. Transferable between owners**	S	No charge	No charge
EA6	Audi Warranty , covering you for up to 4 years or 75,000 miles, whichever comes soonest. Cover includes a two-year unlimited-mileage warranty, and up to 75,000 miles in the third and fourth years. Transferable between owners**	●	£320.83	£385.00
EA9	Audi Warranty , covering you for up to 5 years or 90,000 miles, whichever comes soonest. Cover includes a two-year unlimited-mileage warranty, and up to 90,000 miles in the third, fourth and fifth years. Transferable between owners**	●	£754.17	£905.00

Options are subject to availability and may extend delivery.

- = Not available
- = Available
- S = Standard

**Only available prior to registration of your Audi RS 4. Please speak to your Audi Centre for full details.

RRP – Recommended Retail Price.

VAT is calculated at 20% but this may alter to reflect any change in the applicable VAT rate.

Merchandise

From the enthusiasts' motorsport collection to the sophisticated Audi collection, there's a wide variety of adults' and children's clothing, lifestyle accessories and collectables, all of which bear the Audi name.

Please speak to a member of our team at your local Audi Centre to see the full Audi collection and to place an order. A selection of Audi merchandise is also available to buy from audi.co.uk/merchandise.



Audi Difference

The experts in Vorsprung durch Technik

Our Audi Approved Master Technicians have undergone an impressive 100,000 hours of training over a 10-year programme to ensure they have the latest technical expertise for maintaining and servicing your Audi. All our Service Advisors undergo a specialist induction and training to ensure they are Audi professionals and able to talk to you about any issues you may have with your Audi vehicle.

Servicing tailored to your needs

Regular servicing is key to safeguarding your Audi's performance and a full Audi service history could help you enhance the future re-sale value. To make servicing easy, the Audi Service Schedules have been designed to work with your individual driving style and vehicle.

We offer two different schedules: the fixed Inspection Service and the variable LongLife Service schedule. The conventional fixed Inspection Service schedule has fixed intervals for the Oil-change Service and Inspection Service, which are determined by time and distance.

With the variable LongLife Service schedule, the Inspection Service intervals are also fixed but the Oil-change Service intervals are variable. Sensors take account of driving style and conditions to determine when the Oil-change Service is required and the driver is informed via the on-board service interval display.

The choice of Service Schedule will depend on journey type and mileage as well as individual driving style and conditions. The table to the right can be used for guidance but your Audi Centre will help you to determine the most suitable Service schedule for you based on your individual circumstances and preferences.

Fixed Inspection Service Schedule

	Vehicle usage:
Mileage	Less than 10,000 miles per annum Mainly city/town centre driving. Short journeys.
	Service Intervals:
Oil-change Service	Fixed to every 9,000+ miles/1 year
Inspection Service	Fixed to every 19,000+ miles/2 years

Variable LongLife Service Schedule

	Vehicle usage:
Mileage	More than 10,000 miles per annum Motorway and main road driving. Mainly longer distance journeys. Constant speeds.
	Service Intervals:
Oil-change Service	Variable to a maximum of every 19,000+ miles/2 years
Inspection Service	Fixed to every 19,000+ miles/2 years

When a vehicle is frequently used in the following conditions, we recommend the vehicle is on a Fixed Inspection Service Schedule, regardless of mileage:

Uneconomical driving styles, i.e. heavy acceleration and braking, constant use of high revs
High engine loading conditions, i.e. frequent towing and hill climbs

*As indicated by the service interval display. Mileages are approximate as the Service Indicator system uses kilometres as its distance measurement.

Your convenience comes first

At Audi you can choose from a range of convenient services that suit your needs. Why not book a 'service while you wait' appointment* and enjoy our complimentary refreshments while your car is with us? Or, if you need to be mobile, take advantage of one of our courtesy cars which we can even collect and deliver to you.* We guarantee we can service your Audi within 5 days without a courtesy car, or within 10 days if you need transport. We will also ensure your car is returned to you with a full valet.

Audi Genuine Parts

You can rest assured that only Audi Genuine Parts will be used on your vehicle. What's more, Audi parts and labour come with a 2-year guarantee.**

No hidden costs

We believe strongly in transparency when it comes to our prices. For added peace of mind, we will give you a quotation over the phone for the work you have requested and email you the price confirmation. We'll consult you if any additional work on your car is needed when it is with us. We won't carry out any extra work without asking your permission first.

All part of the service

Whenever we see an Audi for a service, we connect it directly to our headquarters in Ingolstadt which enables us to check your car's software and make sure it's as up-to-date as possible. If the factory has released a software upgrade for your model, it can be applied immediately - improving anything from your car's efficiency to the precision of its parking system.

Audi Roadside Assistance

Your new car comes complete with 3 years' complimentary roadside assistance and recovery across the UK provided by RAC Motoring Services. Also included is roadside assistance throughout Europe, managed by RAC Motoring Services.

For further information and terms and conditions please visit audi.co.uk

* Subject to availability

**Excludes wear and tear.



RS 4 Avant technical data

Engine	4.2 FSI quattro
Transmission	7-speed S tronic
Cylinder	8-cylinder
Displacement, cubic cm (valves per cylinder)	4163
Max. power ¹ , PS at rpm	450/8250
Max. torque, Nm at rpm	430/4000-6000
Top speed, mph*	155
0-62mph acceleration, seconds	4.7
CO ₂ emissions ² , g/km	249
Benefit in kind (BIK)%	35%
Fuel consumption ² , mpg (l/100km) Urban	19.3 (14.6)
Fuel consumption ² , mpg (l/100km) Extra Urban	33.2 (8.5)
Fuel consumption ² , mpg (l/100km) Combined	26.4 (10.7)
ABI insurance group 1-50**	41E
Unladen weight ³ , kg	1795
Gross weight limit, kg	2345
Roof load limit/ nose weight ⁴ , kg	90
Luggage compartment capacity, litres ⁵	490/1430
Fuel tank capacity approx, litres	61

*Electronically limited. Please see page 43 for option to increase limit.

**Highest insurance group rating shown. Group may be lower dependent on trim level. Please visit www.thatcham.org/wabigrouprating for details.

¹The given value was obtained in accordance with the specified measurement procedure (the respective current version of Directive 80/1269/EEC).

²Fuel consumption and CO₂ emissions figures are obtained under standardised test conditions (Directive 93/116/EEC) using a representative model. This allows direct comparison between different models from different manufacturers, but may not represent the actual fuel consumption achieved in 'real world' driving conditions. More information is available at www.vca.gov.uk.

³Vehicle's unladen weight without driver (calculated in accordance with the current version of Directive 92/21/EEC). The fitting of additional equipment may increase the vehicle's unladen weight and drag coefficient, whereupon the potential carrying capacity and top speed will be correspondingly reduced.

⁴Vehicle not suitable for towing equipment.

⁵Second value; loaded up to roof with rear seat folded down.



RS 4 Avant dimensions

The technical drawings opposite show the exact dimensions of the RS 4 Avant, so you can check everything – from whether the car will fit in your garage to whether your luggage will fit in the boot.

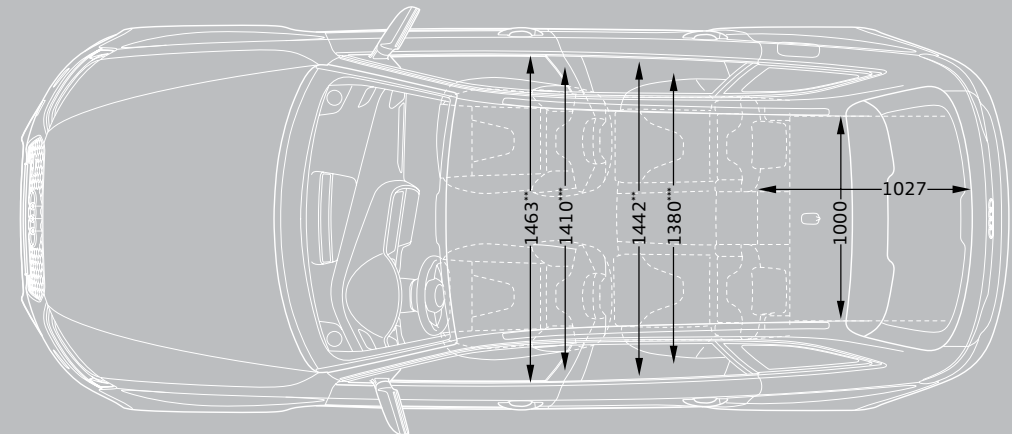
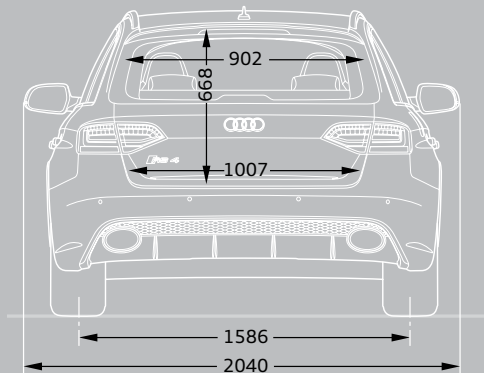
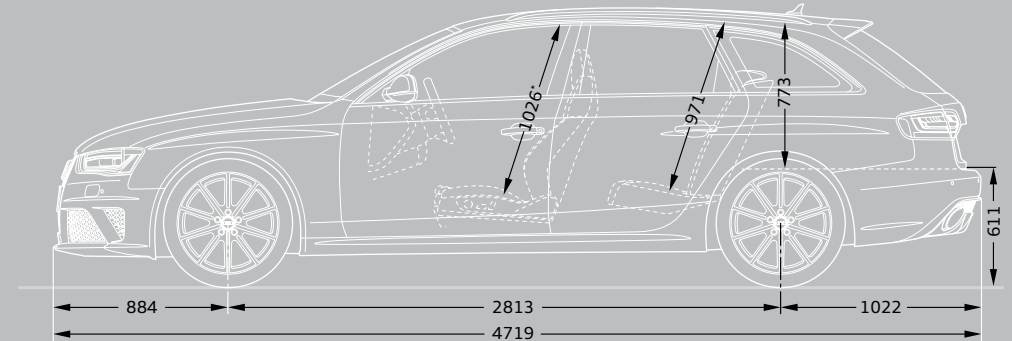
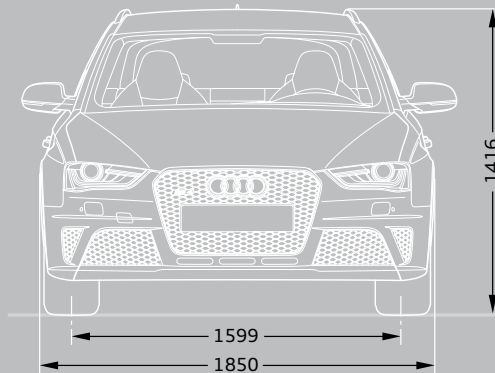

Dimensions in millimetres

*Maximum headroom

**Elbow width room

***Shoulder width room

Dimensions were measured with vehicle at unladen weight, ground clearance measured with vehicle carrying its maximum load.

Luggage compartment volume in litres: 455/829 (measured by the VDA standard test method using 200 x 100 x 50mm blocks; second value: with rear seat folded down). Turning circle approx. 11.6m.

Pricing and Additional information

Welcome to Audi

By placing an order for your Audi, you're choosing to get behind the wheel of one of the most sophisticated cars on the road. And because we believe the service we offer should be just as advanced, we wanted to let you know exactly what you can expect from us, now and in the future.

We've agreed a set of standards with all our Centres, which governs the way we do business with you. It outlines the kind of service we promise to deliver for every customer, right down to filling each new Audi we sell with half a tank of fuel.

So whether you're interested in the date your car will arrive in the UK or the way we'll dispose of non-biodegradable materials after we service your Audi, you can have total confidence in us.

Audi Promise

Audi Centres

We guarantee that all our Centres will be open as follows:

Sales: Monday to Friday 9am–6pm
Saturday 9am–5pm

Service: Monday to Friday 8am–6pm
Saturday 8.30am–1pm

Sunday opening is at local discretion.

New car delivery

Once we've confirmed a delivery date for your car, we'll keep you informed of progress. Subject to reasonable notice, we'll then deliver it to a place of your choice, whether that's your home or work. In the unlikely event of a delay, we'll provide a courtesy car to minimise inconvenience and keep you mobile..

Environmental commitment

We promise to dispose of all non-biodegradable materials from your vehicle in a responsible manner.

*Subject to availability.

**Excludes wear and tear.

Pricing

Prices and specifications given are correct at the time of printing. Always check details with your Audi Centre, as Audi policies are continually developing. We reserve the right to change prices or specifications at any time.

All prices are subject to VAT, currently charged at 20% but this may alter to reflect any change in the applicable VAT rate.

Delivery charges and number plates are not included in the vehicle price.

Delivery charge	£471.66
Number plate	£20.00
VAT	£98.34
Total	£590.00

Audi Insurance is a trading name of Volkswagen Insurance Service (Great Britain) Limited, an appointed representative of Volkswagen Financial Services (UK) Limited, Brunswick Court, Yeomans Drive, Blakelands, Milton Keynes MK14 5LR. Registered in England number 2835230. Audi Insurance is sold, underwritten and administered by Allianz Insurance plc registered in England number 84638. Registered office 57 Ladymead, Guildford, Surrey GU1 1DB. Volkswagen Financial Services (UK) Limited and Allianz Insurance plc are authorised and regulated by the Financial Services Authority. Volkswagen Financial Services (UK) Limited and Allianz Insurance plc are not part of the same corporate group.

Audi Customer Care

Every new Audi benefits from the comprehensive Audi Customer Care Package, which comprises:

- ▶ A 3-year Audi warranty, which covers you for unlimited mileage in the first 2 years of ownership, with a full mechanical and electrical warranty which covers you for up to 60,000 miles in the 3rd year
- ▶ A 3-year paint warranty
- ▶ A 12-year anti-corrosion warranty
- ▶ 3 years' UK roadside assistance and recovery

You also have the option when ordering your new car of choosing a 4-year or 5-year Audi warranty. Speak to a member of the sales team for more information.

Audi Tax-Free Sales

If you are entitled to purchase a vehicle free of VAT, normally through Military or Diplomatic privilege, please contact your local Audi Centre for full details.

Should you have any difficulty obtaining the information you require, please call Freephone 0800 585878.

Audi Finance

Audi Finance specialise in providing funding solutions for Audi drivers. Whether your Audi is for private or business use, there are a range of funding options to choose from.

Below is the full range of finance products.

- ▶ Solutions – a Personal Contract Plan
- ▶ Hire purchase
- ▶ Lease purchase
- ▶ Finance lease
- ▶ Contract hire

With all products, you can choose a fixed-cost maintenance plan designed to help you budget accurately.

No matter what Audi model you choose, your local Audi Centre can provide you with a personalised quote which could fit your budget and motoring needs.

Audi Finance is a trading name of Volkswagen Financial Services (UK) Limited. An offer of finance depends on certain conditions. Available to people over 18 in the UK only.

Audi Insurance

We want you to start enjoying your new car from day one and thanks to Audi Insurance complimentary seven day cover, you can. Call free on 0800 316 7893 (lines are open Monday to Friday 8am - 9pm, and Saturday 9am - 5pm), provide a few details and a cover note will be sent to your Audi Centre. They will then tax your car and you can drive it away.

Additional information

CO₂ data and information

CO₂ emissions-based Vehicle Excise Duty

Vehicle Excise Duty (Road Fund Licence) is based upon the amount of Carbon Dioxide (CO₂) a vehicle emits, measured in grams per kilometre (g/km). First year VED rates apply to the first year of ownership. Annual VED rates apply thereafter. The DVLA has created thirteen categories:

Petrol and Diesel engines	First year	Annual rate (second year onwards)
A – up to 100g/km	£0.00	£0.00
B – 101 to 110g/km	£0.00	£20.00
C – 111 to 120g/km	£0.00	£30.00
D – 121 to 130g/km	£0.00	£100.00
E – 131 to 140g/km	£120.00	£120.00
F – 141 to 150g/km	£135.00	£135.00
G – 151 to 165g/km	£170.00	£170.00
H – 166 to 175g/km	£275.00	£195.00
I – 176 to 185g/km	£325.00	£215.00
J – 186 to 200g/km	£460.00	£250.00
K – 201 to 225g/km	£600.00	£270.00
L – 226 to 255g/km	£815.00	£460.00
M – over 255g/km	£1,030.00	£475.00

Vehicle Excise Duty (VED) rates correct at time of going to print, but these may alter to reflect any change in the applicable VED rate





Audi UK

Customer Services
Selectapost 29
Sheffield
S97 3FG
0800 699888
audi.co.uk

Specifications and prices subject
to change without notice.

© Audi UK

Printed in the UK
Edition 1.3 03/13
2013 model year

Images are for illustrative purposes only.

