

The BMW Z4

www.bmw.co.uk
www.bmw.ie



The Ultimate
Driving Machine



THE BMW Z4.

DRIVEN BY THE HEART.

BMW EfficientDynamics
Less emissions. More driving pleasure.

THE URGE TO MOVE.

PASSION: it's what makes life worth living. Without it, an automobile like the BMW Z4 could not exist. As a true roadster, it embodies this unique feeling in each detail and line of its body. If you want to express your personal passion even more clearly, you can choose the Pure Traction Design package. This transforms the classic sporting personality of the BMW Z4 into an athletic character that adds a very special quality to the car's typical roadster feeling: individuality.





The BMW Z4

MADE TO INSPIRE.

- 06 Design**
Sharpened gaze, accelerated pulse.
- 12 Driving dynamics**
For the love of the road.
- 16 Interior**
Goosebumps for the senses.
- 18 BMW ConnectedDrive**
Listen to your instincts – follow your heart.
- 22 Pure Traction Design package**
Intensity down to your fingertips.
- 30 Motorsport editorial**
A natural for the racetrack.

Technology

DEVELOPED FROM EMOTIONS.

- 32 BMW ConnectedDrive**
So connected, you're free.
- 36 BMW EfficientDynamics**
The technology package for reduced fuel consumption and emissions.
- 38 BMW TwinPower Turbo engines**
Maximum performance combined with minimum fuel consumption.
- 40 Chassis and safety**
Innovative systems for enhanced driving enjoyment.

Equipment

AS INDIVIDUAL AS YOUR DREAMS.

- 44 BMW Z4 sDrive35is**
- 46 Pure Traction Design package**
- 48 M Sport**
- 50 Pure Fusion Design package**
- 52 Colours, upholstery and interior trims**
- 56 Standard / Optional equipment**
- 63 Genuine BMW Accessories**

Overviews

THE BMW Z4 AT A GLANCE.

- 64 Technical data and information on fuel consumption and CO₂ emissions**
- 66 BMW Service and BMW Brand Experience**
Exclusive offers for BMW customers.

www.bmw.co.uk
www.bmw.ie



www.facebook.com/bmwuk
www.facebook.com/bmwireland

Editorial

LET YOUR HEART RULE YOUR HEAD.

While we use our heads to make important decisions, the most emotive decisions are made by our hearts. Choosing the BMW Z4 is an excellent example. The efficiency of its engines is a convincing rational argument – but one look at its irresistible lines is enough to awaken roadster love in the heart of the observer.

So join us for a day of spirited driving on Italy's twisting roads to find which BMW Z4 model makes your heart beat faster. Whether it's as a classic roadster in elegant Mineral Grey metallic or an extravagant athlete with the Pure Traction Design package – the BMW Z4 embodies the excitement of aesthetics and dynamism in more uncompromising style than ever before. Because when it comes to real driving pleasure, there's one emotion that comes first: passion.

www.bmw.co.uk/Z4

Equipment of model shown: BMW Z4 sDrive35is. Pure Traction Design package.

Engine: BMW TwinPower Turbo six-cylinder in-line petrol
Max. output: 340hp (250kW)
Wheels: 19" light alloy M Double-spoke style 326 M with mixed tyres
Exterior colour: Valencia Orange metallic
Upholstery: Black/Orange Alcantara/leather combination
Interior trim: Metal Weave

Equipment of model shown: BMW Z4 sDrive20i.

Engine: BMW TwinPower Turbo four-cylinder in-line petrol
Max. output: 184hp (135kW)
Wheels: 19" light alloy V-spoke style 296 with mixed tyres
Exterior colour: Mineral Grey metallic
Upholstery: Walnut Extended Kansas leather
Interior trim: Finesse Anthracite wood, High-gloss



SHARPENED GAZE, ACCELERATED PULSE.

DECISIVENESS: is what makes things move – it's easy to see that the BMW Z4 has it in abundance. The redesigned headlights with corona rings and white LED eyebrow immediately make your heart beat faster. They lend the front its distinctive appeal and make it absolutely clear that this vehicle was built to excite. Only BMW knows how to build roadsters like this.

**IMPRESSIVE.
EXPRESSIVE.**

FASCINATION: can be expressed in many ways – the contemporary design language of the BMW Z4 is just one of them. It reflects the harmonious interplay of sportiness and elegance. From the trademark kidney grille to the dynamic side creases with redesigned, integrated indicators, to the powerful rear wheel arches – every shape contributes to the car's imposing overall appearance. In addition, the seat position just in front of the rear axle is ideal for perfect road feedback. All of this explains why the BMW Z4 leaves such a positive impression on drivers – and all those who turn their heads to get a second look before it moves out of sight.







FOR THE LOVE OF THE ROAD.

TRUST: is the basic prerequisite for a close relationship with the road – and true roadster spirit. With the BMW Z4, BMW engineers have demonstrated once more how to become one with the road. The aluminium front suspension makes a key contribution here – it reduces front axle weight for an ideal 50/50 weight distribution, ensuring precise and agile handling all the way up to the car's limits.

But when it comes to exploring the physical limits of driving, the handling of the BMW HP4 motorcycle is no less impressive. As in the BMW Z4, top-quality materials and innovative technology such as Dynamic Damper Control (DDC) and Dynamic Traction Control (DTC) as well as Race ABS ensure maximum traction and safety. Despite its power, the 193hp BMW HP4 delivers outstanding control combined with exceptional agility and dynamic behaviour on both road and track.

In a BMW, it makes no difference whether it's two or four wheels touching the ground – they all share a love of the road.



**MORE
EXCITEMENT
WITH EVERY
BREATH.**

VERVE: is something that comes naturally in the BMW Z4. Its aluminium front axle saves a significant amount of weight, ensuring a balanced front-rear weight distribution. The BMW TwinPower Turbo four-cylinder petrol engine in the BMW Z4 sDrive20i exploits this advantage: its 184hp (135kW) of power delivers an immediate punch as soon as you put your foot to the pedal, accelerating the car from 0 to 62mph in just 6.9 seconds. In partnership with the eight-speed automatic transmission this creates a peerless and breathtaking driving experience. It's one time your head and your heart will be in happy agreement: because at just 41.5mpg (6.8l/100km), the car's fuel efficiency is equally impressive.



GOOSEBUMPS FOR THE SENSES.

EXUBERANCE: comes naturally in the BMW Z4 – all you need to do is get in. It doesn't matter how fast you want to go, the optional Sport seats for the driver and passenger offer outstanding lateral support for spirited driving. SunReflective Technology ensures that the leather upholstery is comfortable even in direct sunshine, enabling you to enjoy open-top driving to the full. Beautiful craftsmanship and premium materials like fine wood and high-gloss trim elements create an exclusive ambience in the interior – making every drive in the BMW Z4 a journey of discovery for all the senses.



ADDICTED TO FREEDOM.

INDEPENDENCE: means freedom. In the BMW Z4, it also means a plethora of innovative functions. BMW ConnectedDrive Services, Apps and Driver Assistance systems connect you with the outside world: keep in touch via Facebook or Twitter and share moments with your friends. With standard BMW Emergency Call, you can be assured that in an emergency, this service connects your vehicle to the local Emergency Services. In addition, the free AUPEO! personal internet radio app ensures that each drive will be accompanied by your own personal soundtrack. Freedom of choice is at the heart of this service: you pick your own musical preferences from a library of 120 genres and around 1 million songs. The result is that the BMW Z4 makes it even easier to escape the daily routine – without having to compromise on comfort.





THE THRILL OF ATTRACTION.

DESIRE: is awakened as something casts a spell over us. One place that has this power of attraction is the cockpit of the BMW Z4, equipped with the Pure Traction Design package, which combines spirited design with perfect ergonomics. The asymmetrical centre console faces the driver, as does the instrument panel, whose round controls hark back to the legendary BMW Z8. The Pure Traction Design package includes the premium Alcantara/leather combination upholstery and decorative stitching in distinctive Orange, which make for a strikingly sporty ambience – and provides an unforgettable caress to the fingertips with every touch.



ADRENALINE LEVEL – LIMITLESS.

EUPHORIA: is like a spark that sets our feelings alight. One look at the Valencia Orange metallic paint, exclusively available within the Pure Traction Design package, combined with the BMW Individual hardtop in contrasting non-metallic Black, immediately makes the adrenaline level rise. It emphasises the distinctive sporty character of the BMW Z4, turning it into an even more consummate athlete. This impression remains unchanged even with the roof up, because the aluminium hardtop's lines harmonise perfectly with the design of the body, just like the top does not compromise the roadster's typically slim rear when retracted. One press

of a button is enough to start the fully automatic closing process, which takes around 19 seconds to complete and can be initiated at speeds of up to 20mph, where opening the roof takes 22 seconds. Whether the hardtop is up or down isn't a question of style, but simply a response to the needs of the moment.

THE EXTRAVAGANCE OF HIDDEN RESERVES.

STRENGTH: implies having the confidence to master any challenge. The BMW Z4 makes an extravagant statement in any situation – providing a first indication of its superiority. The optional Adaptive M Sport suspension enables it to transmit its full power to the road, taking dynamic ability to a new level without ever compromising comfort. For a lower centre of gravity and higher cornering speeds, ride height is lowered by ten millimetres. Sensors capture all relevant acceleration data and perform automatic adjustments of damping parameters within hundredths of a second. With Drive Performance Control, you can always make sure that the strengths of the BMW Z4 are deployed to maximum effect.





OVERPOWERS THE MIND. UNLEASHES THE HEART.

ECSTASY: proves that passion can always be taken to another level. The BMW TwinPower Turbo six-cylinder in-line petrol engine in the BMW Z4 sDrive35is proves it: up to 450Nm of torque and 340hp (250kW) of power propels the roadster from 0 to 62mph in just 4.8 seconds. As it does so, you'll find your heartbeat accelerating at the same rate. Every gear change is executed within fractions of a second by the standard seven-speed Double Clutch Transmission (DCT) without any gaps in

power delivery – unleashing pure intensity and instantly making one thing clear: that your heart is in charge.



Udo Mark is the head of Customer Sports at BMW Motorsport. In this interview, he talks about the BMW Z4 GT3.

Hardly a weekend goes by without a BMW racing car driver winning a race somewhere in the world. This does not just apply to the BMW Motorsport drivers participating in the DTM or the American Le Mans series; private teams use our race cars to participate in all kinds of championships around the globe. Leading the BMW Motorsport field is the BMW Z4 GT3.

Sportiness is part of the heritage of every BMW. Is this why BMW automobiles are so uniquely suited for the racetrack?

Of course. Every BMW is sporty by nature. This is a good basis for motorsport success. We at BMW Motorsport build on this basis to develop race cars that have the potential to earn victories across the world.

The BMW Z4 GT3 is your most successful model. Where do you use it?

The BMW Z4 GT3 has proven a true winner in the hotly contested GT3 class, in which almost all the big-name manufacturers are represented with special models. Whether it is a 24-hour endurance race or a prestigious series such as the FIA GT1 Championship, with the BMW Z4 GT3, we will be a top competitor in any race.

A NATURAL FOR THE RACETRACK.



What makes the BMW Z4 GT3 so special?

The elongated bonnet, long wheelbase and short overhangs combine to lend the volume version of the BMW Z4 its unmistakable appearance. One difference between the volume model and the race car is hidden under the bonnet: while the road version of the BMW Z4 is powered by either a six-cylinder or a four-cylinder engine, the motorsport version is fitted with a 4.4 litre eight-cylinder powerplant by BMW M. In addition, there are modifications in the chassis, brakes and aerodynamics features. One key characteristic of a race car is its versatility. Different teams from around the globe must be able to quickly adapt the BMW Z4 GT3 to the needs of each racetrack and their drivers.

Which other BMW cars are part of the BMW Motorsport range?

Our teams have also been very successful with the BMW 320 TC in the World Touring Car Championship. And the BMW M3 GT4 remains our motorsport entry-level model.

You are also supporting private BMW race drivers with the BMW Sports Trophy. Could you tell us more about this award?

We really value private drivers, for their strong performances and racing success. This is why we award trophies to the most successful among them. And this year, in addition to €250,000 in prizes, we have a special treat: a test drive in the BMW M3 DTM.

What did you think was the highlight of the 2012 motor racing season?

Of course we followed the comeback season of our colleagues in the DTM with great interest. The phenomenal success of BMW Motorsport after their return to the DTM is fantastic. But we also had some resounding successes with the BMW Z4 GT3. One absolute highlight was Uwe Alzen's record lap in the qualifying at this year's Nürburgring 24-hour race. We also celebrated other victories, nearly every weekend. 2012 was a truly outstanding year for BMW Motorsport.

BMW ConnectedDrive So connected, you're free.



Our world is becoming more connected every day with instant access to information at anytime and anyplace. With your BMW being an integral part of your lifestyle we believe it's important that you can keep up to date from behind the wheel. BMW ConnectedDrive delivers intelligent solutions that allow you to remain connected whilst on the move.



Advanced driver assistance systems can connect you to the outside world so that you know exactly what is happening around you, premium traffic solutions ensure you are taking the most time efficient route whilst online services provide direct access to information about your current location or chosen destination. Today, driving enjoyment is derived as much from being informed and relaxed as it is from impressive performance and efficiency – discover how the comprehensive range of ConnectedDrive technologies can enhance the connected capabilities of your Ultimate Driving Machine.

For more information please visit:

www.bmw.co.uk/ConnectedDrive
www.bmw.ie/ConnectedDrive

BMW CONNECTED DRIVE SERVICES AND APPS.

Wherever your journey may lead, you can stay in touch with BMW ConnectedDrive Services. The range of innovative functions provide optimum integration between the driver, vehicle and the world outside – anytime, anywhere.



BMW EMERGENCY CALL.

Known as BMW eCall, this service provides a direct link to the local Emergency Services. You can summon help manually by simply pressing the SOS emergency call button to request for assistance. Additionally, if your vehicle is involved in a more serious accident an automatic emergency call is made, providing extra reassurance that if you cannot call for help, your BMW will act on your behalf. With either the manual or the automatic emergency call, details of your vehicle and location will be sent directly to an Emergency Service Centre, so that immediate action can be taken and assistance dispatched without delay. BMW Emergency Calls are made using the integrated BMW SIM card so no mobile phone is required.



REAL TIME TRAFFIC INFORMATION (optional).

Provides a precise account of current traffic situations in real time. The information is presented on the Navigation map by using a colour coding system indicating the flow of traffic. Road networks are divided into distances as short as 500m for superior accuracy and dependency. Information is automatically updated every 3 minutes allowing the driver to monitor whether the traffic situation is improving or worsening. The system also recommends for or against alternative routes based on the potential time saving benefits.



INFORMATION PLUS (optional).

At the push of a button local information is available wherever you may be. The service connects you to a BMW operator who will be able to quickly access the information you need. So whether you are looking for a nearby hotel, restaurant or simply can't find your way then support is conveniently on hand. Information can be sent directly to your BMW so that addresses can be transferred to your Navigation system. Information Plus calls are made using the integrated BMW SIM card so there is no need for a mobile phone and you can use the service as much as you like at no additional cost.

BMW CONNECTED DRIVE SERVICES AND APPS.



MOBILE OFFICE (optional).

With a compatible mobile device you can access a host of features, including your contact lists, text messages, calendar entries and emails directly through your Control Display using the iDrive controller. Details can even be read out to you with the text-to-speech function, and with Message Dictation (with BMW Professional Multimedia Navigation system) your spoken reply is converted into a text document that you can then send out. So you can make profitable use of your time behind the wheel, and remain focussed on what's most important: the road ahead.

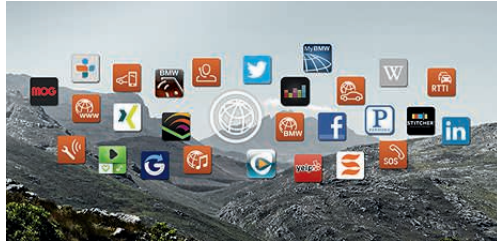

BMW APPS INTERFACE (optional).

With the BMW Apps interface, users can download the free 'BMW Connected' iPhone application. This allows you to integrate a range of popular smartphone apps within your vehicle. Using the iDrive controller, you can select web radio stations from around the world, call up the latest status reports from your Facebook and Twitter accounts and view your iCalendar on the vehicle Control Display.



BMW ONLINE SERVICES (optional).

With the internet-based services from BMW Online you can conveniently keep up to date with the latest news and sports headlines from the comfort of your BMW. You can plan ahead with Google™ send-to-car and a detailed five-day weather forecast. Search for accurate location-based information in a live online database and stay in touch with your emails using the BMW Online Office. No mobile phone is required since access to BMW Online information is via the integrated BMW SIM card, so you can use the services as much as you like at no additional cost.

BMW CONNECTED DRIVE DRIVER ASSISTANCE.

The comprehensive range of advanced driver assistance systems from BMW ConnectedDrive seamlessly integrate the driver into their immediate environment. Headlights, sensors, cameras and radars can combine to ensure the driver is fully informed about what is happening around them, delivering superior comfort and convenience as well as enhanced safety for both passengers and other road users.



PARK DISTANCE CONTROL (optional).

This allows for easy parking and manoeuvring in confined spaces. Acoustic signals and a visual indicator in the Control Display advise you when the front or rear of the vehicle is approaching an object. Distances are measured by ultrasound sensors in the bumpers.



COMFORT ACCESS (optional).

This system allows you to unlock, lock and start your BMW without inserting or having to hold the key in your hand. When you have the key fob on your person, simply touch the door handle or boot lid and the BMW unlocks or locks as required by transmitting an identification signal to the car. Similarly, a touch of the Start-Stop button is all it takes to start the engine.



BMW EfficientDynamics Less emissions. More driving pleasure.

BMW was one of the first manufacturers to pursue the goal of efficient drive technologies, as part of a multi-award-winning sustainability strategy. BMW EfficientDynamics represents an acclaimed standard package of innovative technologies that reduce fuel consumption and emissions, while simultaneously enhancing dynamic performance. It has enabled the BMW Group to lower the CO₂ emissions of its European new-vehicle fleet by more than 30% since 1995. Currently, the majority of models produce less than 140g of CO₂ per km. The BMW Group intends to achieve a further 25% reduction in CO₂ emissions by 2020.



BMW EFFICIENT DYNAMICS – MAKING A LITTLE GO A LONG WAY.

Different paths to the same destination: unmistakable BMW driving pleasure. Under the umbrella of the BMW EfficientDynamics project, BMW is continuously developing innovative systems that will bring us closer to the goal of emissions-free mobility in the long term.

THE BMW EFFICIENT DYNAMICS MEASURES IN THE BMW Z4 AT A GLANCE.

Auto Start-Stop. Auto Start-Stop automatically switches off the engine when the vehicle is stationary and the driver de-clutches. As soon as you engage the clutch or take your foot off the brake, the engine immediately starts up again and your journey continues. And without any effort on your part, you've saved fuel and helped protect the environment.

Servotronic. Varies the level of assistance according to vehicle speed. For instance, at low speeds steering will be light, as speed increases the steering becomes firmer.

BMW TwinPower Turbo technology. BMW take a TwinScroll turbocharger with VALVETRONIC, Double-VANOS and High-precision direct injection. In this way, BMW TwinPower Turbo significantly reduces the fuel consumption of petrol engines, while at the same time improving power delivery across a range of engine speeds.

Brake Energy Regeneration. Now when you brake, you won't just be slowing yourself down, you'll be helping to keep your car moving. It sounds counter-intuitive, but whenever you apply the brakes or take your foot off the accelerator and coast, you recycle energy instead of wasting it. Brake Energy Regeneration then uses this energy to recharge the battery. In the process, it reduces the demand on your engine, means you consume less fuel and keeps down your CO₂ emissions.

Optimum Shift Indicator. Changing gear at the right time can produce significant fuel savings. In Z4 models with manual transmissions, the optimum gear shift indicator tells you which gear you should select to increase fuel efficiency. The display is conveniently positioned directly in your line of vision. Depending on your driving style, the system also recommends how to go up and down the gears more effectively.

Lightweight Engineering. To make each journey even more effortless, we've introduced lightweight materials (such as aluminium) to create lighter engines and bodywork across the BMW range. The new materials reduce drag, making the car more responsive. Engine and drivetrain components contain ultra-modern magnesium alloys. Up to 24% lighter, they improve the dynamics of the vehicle thanks to a balanced weight distribution between front and rear axle. And, of course, the lighter the car the less fuel you use and fewer CO₂ emissions you produce.

ENGINES WITH THE RIGHT VALUES FOR ACCELERATION.

The engines. Power, responsiveness and revving ability characterise every BMW engine. Naturally, all the engines available for the BMW Z4 follow the BMW EfficientDynamics philosophy, aiming to combine ultimate performance with maximum efficiency, minimising both fuel consumption and CO₂ emissions. Whichever of the innovative BMW TwinPower Turbo engines you choose, you can be certain that you will enjoy maximum driving pleasure combined with superb efficiency.

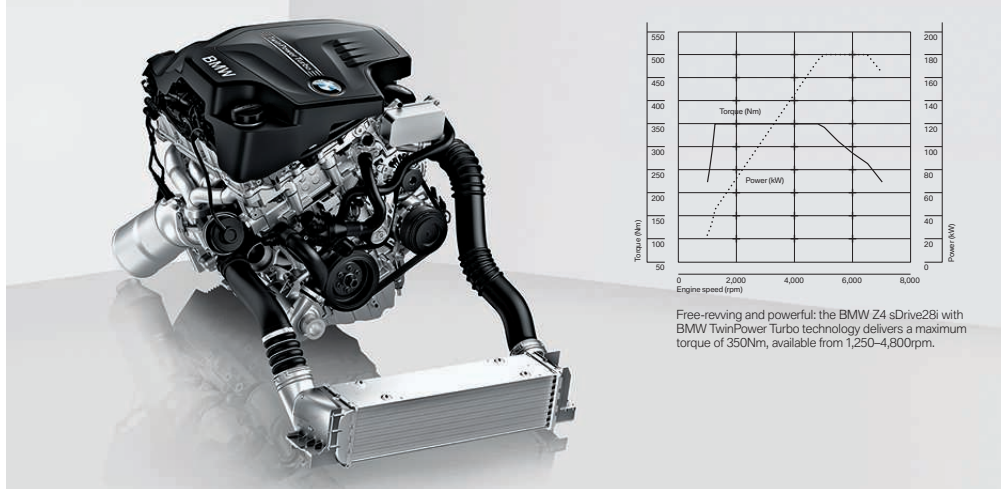

Free-revving and powerful: the BMW Z4 sDrive28i with BMW TwinPower Turbo technology delivers a maximum torque of 350Nm, available from 1,250-4,800rpm.

BMW Z4 sDrive18i. The BMW TwinPower Turbo four-cylinder petrol engine in the BMW Z4 delivers a maximum output of 156hp (115kW) along with a maximum torque of 240Nm, and combines a TwinScroll turbocharger with VALVETRONIC, Double-VANOS and High-precision direct injection. Combined with the six-speed manual gearbox (eight-speed Sport automatic transmission available as an option), it powers from 0 to 62mph in 7.9 seconds, and up to a top speed of 137mph (221km/h).

BMW Z4 sDrive20i. The BMW TwinPower Turbo four-cylinder petrol engine with High-precision direct injection, VALVETRONIC and Double-VANOS combines powerful performance with outstanding efficiency. The 2.0 litre engine delivers an output of 184hp (135kW) and a maximum torque of 270Nm, enabling the BMW roadster to accelerate from 0 to 62mph in 6.9 seconds, and to reach a top speed of 146mph (235km/h).



BMW Z4 sDrive28i. The 2.0 litre BMW TwinPower Turbo engine offers its maximum torque of 350Nm from as little as 1,250-4,800rpm. This is thanks to High-precision direct injection, VALVETRONIC and a TwinScroll turbocharger. With a power output of 245hp (180kW), the BMW accelerates quickly and effortlessly, aided by the fast response of its TwinScroll turbocharger, going from 0 to 62mph in just 5.7 seconds. An outstanding performer, it offers a top speed of 155mph (250km/h), while fuel consumption is a very efficient 41.5mpg (6.8l/100km).

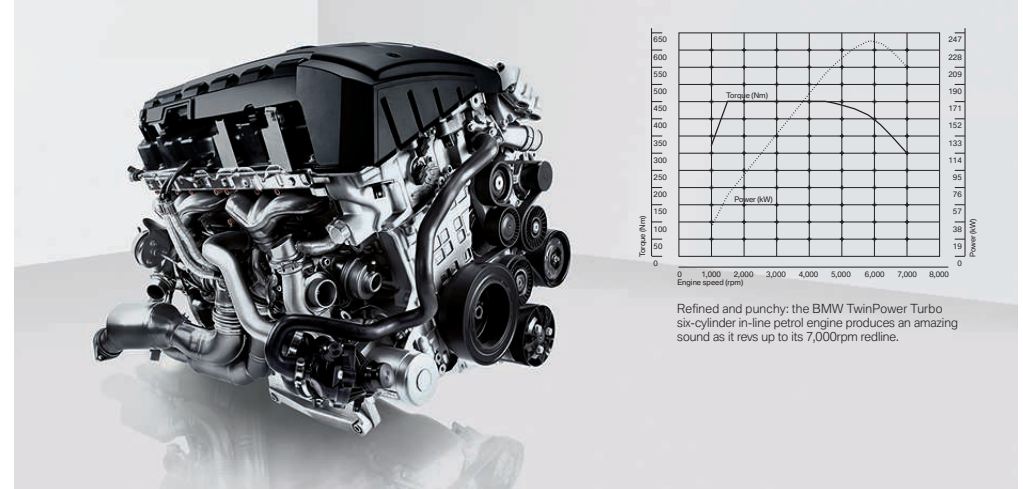

Refined and punchy: the BMW TwinPower Turbo six-cylinder in-line petrol engine produces an amazing sound as it revs up to its 7,000rpm redline.

BMW Z4 sDrive35i. This model's BMW TwinPower Turbo six-cylinder in-line petrol engine has a capacity of 3.0 litres and combines two turbochargers with Double-VANOS and High-precision direct injection to deliver a power output of 306hp (225kW) with 400Nm of torque available from just 1,300rpm. The engine's revving ability is also impressive, accelerating the BMW from 0 to 62mph in just 5.2 seconds, at up to 7,000rpm. Average fuel consumption is 30.1mpg (9.4l/100km), with CO₂ emissions of 219g/km.

BMW Z4 sDrive35is. The most powerful BMW TwinPower Turbo six-cylinder in-line petrol engine combines two turbochargers with Double-VANOS and High-precision direct injection. Based on its 3.0 litre capacity, it delivers an impressive 340hp (250kW) of power, and a stupendous 450Nm of torque. Thanks to a boost function, short-term peak torque is even higher, at 500Nm. In conjunction with the standard seven-speed automatic Double Clutch Transmission (DCT) the six-cylinder in-line engine provides continuous power uninterrupted by gear changes, catapulting the BMW Z4 from 0 to 62mph in just 4.8 seconds - with an average fuel consumption of just 31.0mpg (9.1l/100km) and CO₂ emissions of 211g/km.



It's a quality that each and every BMW embodies: pure dynamic ability. The technical foundation of this exhilarating driving experience is the chassis. It ensures optimum road contact and ideal handling in every situation. It's the result of innovative, perfectly matched components and a 50/50 front-rear weight distribution. At the same time, BMW engineers continuously reinvent and refine the typical BMW driving dynamics. Every BMW chassis has the effect of transmitting a passion for sporty driving from the vehicle to the driver – while also offering maximum safety and comfort.



THE IDEAL BASIS FOR DYNAMIC PERFORMANCE. AN EXCELLENT CHASSIS.

The BMW Z4 offers a whole host of innovative optional technologies to help you get the most out of each drive. Many of these systems are intelligently linked with each other. Their interaction ensures that you can enjoy maximum driving pleasure, with maximum safety – on every straight, in every corner, every second of your drive.

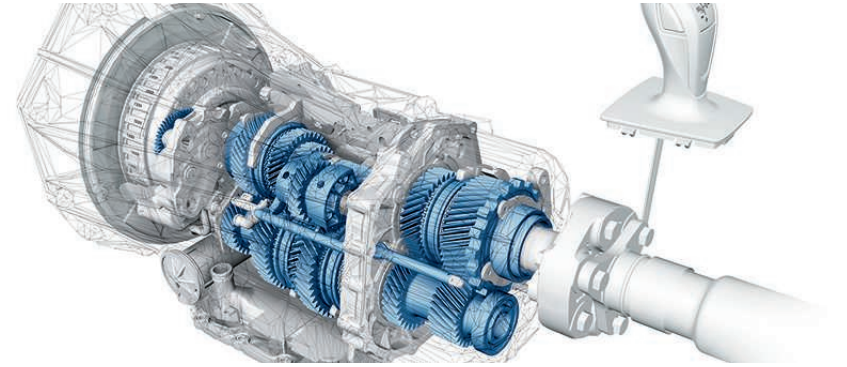

Adaptive M Sport suspension. This features electronically controlled dampers that adapt to both driving style and road conditions. Their operating characteristics can be adjusted via the Drive Performance Control button. The optional suspension (standard in the BMW Z4 sDrive35is) is also lowered by 10 millimetres, without any adverse effects on the ride comfort.

Rear-wheel drive. This is the basis of the hallmark BMW agility and manoeuvrability. At the same time, this drive configuration enables an ideal weight distribution across the entire chassis. This makes for perfect transmission of power and traction to the road.

Steering. Torque steer is completely alien to the BMW Z4 Roadster. With rear-wheel drive, the drive wheels are not the ones steering the car, so the power applied to them can never affect the steering. The steering is evenly weighted and does not harden, and steering angles are small. The result is that you can literally feel cornering speed and road surface condition.

Drive Performance Control. This enables an individual adaptation of powertrain and chassis components, for example the steering, by selecting either Comfort, Sport or Sport+ mode. The Sport+ mode enables very sporty driving all the way to the car's limits. For example by permitting more wheel slip on the rear wheels – something that you can allow at any time by pressing the 'Traction' button.

Sport automatic transmission. This optional eight-speed transmission adjusts to your style of driving – from comfortable cruising to a very dynamic experience indeed. To change gears, you can either use the shortened selector lever or the gearshift paddles on the sport leather steering wheel. The close spacing of the eight gears optimises acceleration, while also maximising efficiency and shift comfort.

Seven-speed automatic Double Clutch Transmission (DCT). Allows gear changes without a break in the flow of power to the rear wheel. Integrated with Drive Performance Control, the uninterrupted power flow from the engine gives breathtaking acceleration combined with supreme ride comfort thanks to the almost imperceptible gear changes. In addition, the fast and precise selection of the most efficient gear significantly reduces fuel consumption in automatic mode.

OPTIMUM SAFETY THANKS TO THE LATEST BMW TECHNOLOGIES.

The BMW Z4 features advanced technologies on which you can always rely. Superior driving characteristics and innovative equipment come as standard in this car. As a driver, you will be supported by state-of-the-art technology able to give you maximum support in any situation, making you feel safe no matter what condition the roads are in.

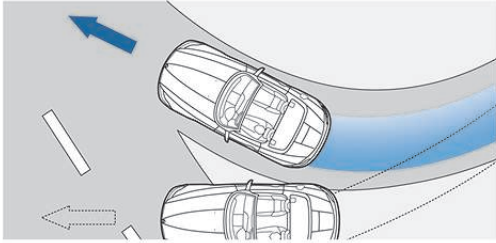

■ **Dynamic Stability Control (DSC)**, including Cornering Brake Control (CBC), Hill-start Assistant (sDrive 35i/sDrive 35is only), Brake Assist and Dynamic Brake Control (DBC). DSC recognises the risk of skidding before it occurs and stabilises the car in milliseconds. The Dynamic Traction Control (DTC) allows increased wheel slip to optimise acceleration in certain driving conditions and to enable more dynamic driving.

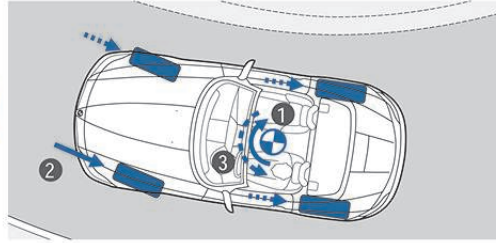

■ **Cornering Brake Control (CBC)** increases vehicle stability when braking gently in a fast bend. During braking manoeuvres, the load on the rear wheels is reduced, which can lead to oversteering (1). In brake manoeuvres that are outside the ABS control range, CBC addresses this tendency using asymmetric brake pressure control (2) in order to create a stabilising counterforce (3).

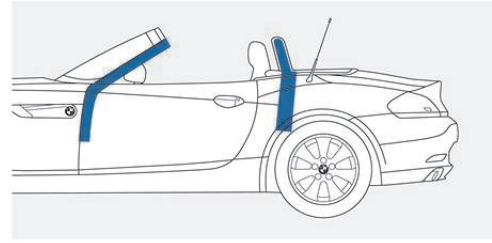

■ **Rollover protection system**, comprises two steel roll bars behind the headrests, together with a high-tensile chassis cross member. The system also includes a roll bar of high-strength tubular steel integrated into the roof and A-pillars providing maximum safety should the car turn over.

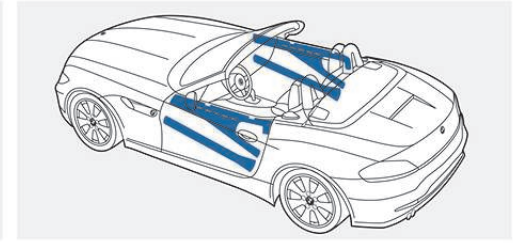

■ **Door reinforcements** provide maximum occupant protection in the event of a side impact. Added strength is provided by diagonal crossmembers in the doors.

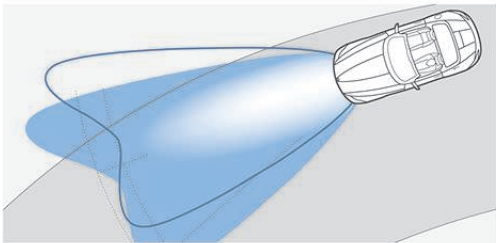

□ **524 Adaptive Headlights** with variable light distribution, including cornering lights, illuminate bends at greater distances by optimally adjusting the swivelling headlights as soon as the driver turns the steering wheel. To improve short-range visibility, the cornering lights integrated into the foglights are automatically activated, even when the vehicle is at a standstill, as soon as the indicator is switched on or the steering wheel is turned.

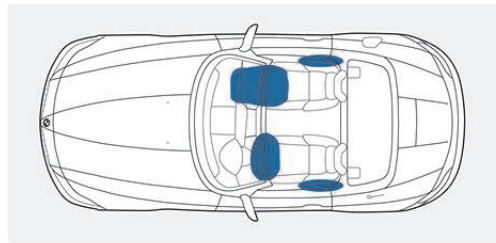

■ **Airbag system:** In a BMW, all safety features complement each other perfectly. Four airbags offer specific protection: driver and front passenger airbags, as well as head and upperbody airbags which cushion the head, ribcage and pelvis area.

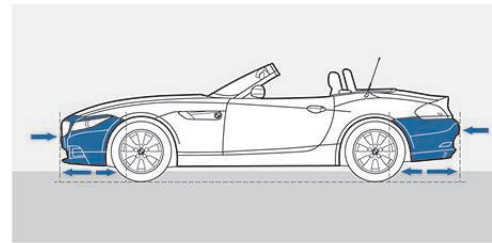

■ **Bumpers** with reversible aluminium impact absorbers at the front (steel impact absorbers at the rear) withstand impacts at up to 2.5mph (4km/h) without damage. Special deformation zones at the front and rear absorb impact forces at speeds of up to 9mph (15km/h) without damage to the car's body.

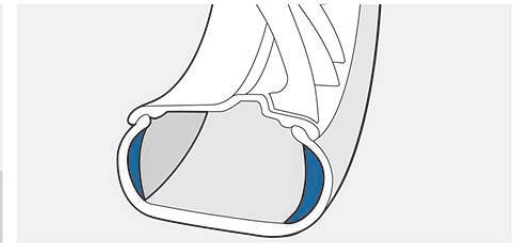

■ **Run-flat tyres** are fitted as standard. These tyres feature reinforced side walls which maintain their shape and rim position even after suffering a complete loss of pressure. The driver is warned of a slight decline in tyre pressure by an indicator in the instrument panel. If the pressure loss is more serious, an additional acoustic warning is triggered.

■ **Tyre Pressure Monitoring.**

BMW Z4 sDRIVE35is – DYNAMIC.

The BMW Z4 sDrive35is stands for uncompromising driving enjoyment. BMW TwinPower Turbo technology enables the BMW Z4 sDrive35is to deliver an impressive output of 340hp (250kW) and an equally impressive torque of up to 450Nm – thanks to a boost function, short-term peak torque is even higher, at up to 500Nm. With sporty seven-speed Double Clutch Transmission (DCT) as standard, the six-cylinder in-line engine can rev up to a 7,000rpm redline and takes just 4.8 seconds to accelerate the car from 0 to 62mph, its power delivery uninterrupted by gear changes. Its average fuel consumption is a frugal 31.0mpg (9.1l/100km), with CO₂ emissions of 211g/km. The dynamic power that the BMW Z4 sDrive35is is able to unleash is apparent just from looking at it. The standard 18" light alloy Star-spoke style 295 wheels with mixed tyres reflect this car's thoroughbred character. Its appearance is defined by the long bonnet, short overhangs and low position of the seats close to the rear axle. An exclusively modified aerodynamics package in vehicle colour, consisting of a front apron with integrated Matt Aluminium twist motif, a colour coded rear bumper inset with diffuser panel, and exterior mirrors with a matt Oxide Silver finish completes the aesthetic and powerful appearance.

Adaptive M Sport suspension comes as standard, ensuring superior road holding, with Sport seats providing perfect lateral support. The interior of the BMW Z4 sDrive35is radiates sporting appeal and highlights include optional Alcantara/leather combination upholstery in Black with Orange contrast stitching, Carbon Aluminium interior trim, and surrounds for the Control Display and vents in High-gloss Black. The M leather steering wheel with multi-function buttons and paddles, M door sills, floor mats with sDrive35is designation and Anthracite Headlining round off the overall appeal of the cabin.



Pure Traction Design package includes Metal Weave interior trim combined with Black, High-gloss surrounds, and rounds off the appeal of the cockpit. See pages 46-47 for further information regarding the Pure Traction Design package.



Eye-catching appearance.



Black Sapphire metallic paint emphasises this car's athletic looks.

PURE TRACTION DESIGN PACKAGE – SPIRITED.

The BMW Z4 Roadster embodies a passion for the road as well as undiluted joie de vivre. The Pure Traction Design package is one way of expressing this joy. It combines Metal Weave interior trim with Sport seats in Black Alcantara/leather combination which is enriched by contrasting Orange highlights. The Alcantara door inserts and instrument panel bottom come in either Orange or Black to provide athletic accents and Extended Kansas leather upholstery is available as an option. The centre console surround and door handle inserts in Piano Black provide highlights which radiate a powerful energy. An exclusive exterior paint in Valencia Orange metallic combines with the contrasting Black hardtop to emphasise the sporty character of this car. The Pure Traction Design package can optionally also be combined with various other exterior colours.



Alcantara/leather combination upholstery with Orange highlights.



Coloured door panel insets.



Valencia Orange metallic paint, exclusive to the Pure Traction Design package.



Pure Traction Design package sporty interior.

BMW Z4 M SPORT – ATTRACTIVE.

Independently of what engine you select for your BMW Z4, you can emphasise the dynamic appearance of this timelessly beautiful roadster by opting for an exclusive M Sport model. This provides your vehicle with excellent aerodynamic qualities and even sportier looks, courtesy of the M aerodynamics bodystyling with specially designed front and rear aprons and M designation on the front side panels. Complete the exterior look with standard 18" M light alloy Star-spoke style 325 M wheels with mixed tyres or optional 19" M light alloy Double-spoke style 326 M wheels (shown below). The M Sport suspension on this model ensures impressively agile handling, while the M Sport leather steering wheel provides excellent grip. For an even more confident appearance, you can order your BMW Z4 with a striking exterior in Melbourne Red metallic, an optional paint available exclusively for M Sport models. Interior features include Sport seats for the driver and passenger, M door sill inlays, Anthracite Headlining as well as the attractive Aluminium Carbon interior trim.



For exceptional grip – the M Sport leather steering wheel.



Door sill inlays with M designation.



Exclusive Melbourne Red metallic paint.



M aerodynamic bodystyling.

PURE FUSION DESIGN PACKAGE – EXCLUSIVE.

This equipment package provides an especially high-quality, harmoniously balanced combination of colours and materials. This includes exclusive Sparkling Brown metallic paint, which creates a warm, dark appearance. If you wish, you can of course combine the Pure Fusion Design package with other exterior colours. With the Pure Fusion Design package, the interior of the BMW Z4 provides an exquisite contrast with velvety soft Exclusive Nappa leather upholstery in Ivory White. This sophisticated upholstery is stylishly complemented by the Finesse Brown wood, High-gloss interior trim. The Pure Fusion Design package also comes with elegant Sport seats, which will attract admiring glances and provide superior support in every driving situation.



Automatic air conditioning controls offset by Finesse Brown wood interior trim.



A sophisticated contrast: the centre console reflects the interplay of Exclusive Nappa leather in Ivory White and Finesse Brown wood, High-gloss interior trim.



Matched to aesthetic perfection: the colours and materials in the interior.











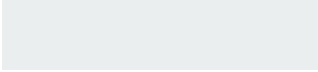



The Sparkling Brown metallic paint finish conveys a harmonious appeal.



The sporty and elegant interior provides optimal ergonomics for the driver.











Exterior colours.

		
<input checked="" type="checkbox"/> 300 Alpine White Non-metallic	<input checked="" type="checkbox"/> 668 Jet Black¹ Non-metallic	<input checked="" type="checkbox"/> A61 Crimson Red¹ Non-metallic
		
<input type="checkbox"/> 475 Black Sapphire Metallic	<input type="checkbox"/> A76 Deep Sea Blue Metallic	<input type="checkbox"/> B39 Mineral Grey Metallic
		
<input type="checkbox"/> A75 Melbourne Red² Metallic	<input type="checkbox"/> B44 Valencia Orange³ Metallic	<input type="checkbox"/> A83 Glacier Silver Metallic
		
<input type="checkbox"/> B53 Sparkling Brown⁵ Metallic	<input type="checkbox"/> A96 Mineral White Metallic	
		
<input type="checkbox"/> BMW Individual	<input type="checkbox"/> BMW Individual contrasting roof³ 668 Black, non-metallic	

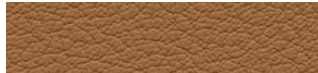
On sDrive35i/sDrive35is models, metallic paint is standard and non-metallic paint is optional.

These pages show the colours and materials available for the BMW Z4. Use them to identify your favourite colours, or compare various combinations. These colour samples are meant to give you a first impression of paints and materials. Experience has shown, however, that printed versions of paint, upholstery, and interior trim colours cannot always faithfully reproduce the colour appearance of the originals. We recommend therefore that you consult your BMW Dealer who will be happy to show you original samples and assist with any requests.

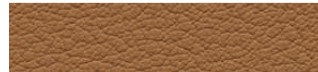
Upholstery colours.

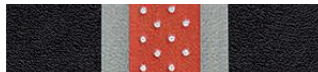
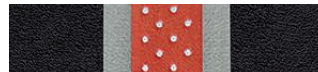
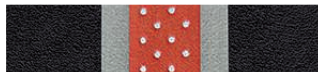
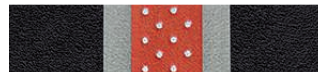
		
<input checked="" type="checkbox"/> ASAT Anthracite⁴ Panama cloth		
		
<input type="checkbox"/> LYSW Black Kansas leather	<input type="checkbox"/> LYCY Canberra Beige Kansas leather	<input type="checkbox"/> LYD1 Coral Red Kansas leather
		
<input type="checkbox"/> LYSY Walnut Kansas leather	<input type="checkbox"/> PASW Black Extended Kansas leather	<input type="checkbox"/> PACY Canberra Beige Extended Kansas leather
		
<input type="checkbox"/> PAD1 Coral Red Extended Kansas leather	<input type="checkbox"/> PASY Walnut Extended Kansas leather	
		
<input type="checkbox"/> NAEW Ivory White⁵ Exclusive Nappa leather		
		
<input type="checkbox"/> GMOE Black/Orange/Black^{3,6} Alcantara/leather combination	<input type="checkbox"/> GMOF Black/Orange^{3,6} Alcantara/leather combination	
		
<input type="checkbox"/> GUOE Black/Orange/Black^{3,6} Extended Alcantara/leather combination	<input type="checkbox"/> GUOF Black/Orange^{3,6} Extended Alcantara/leather combination	

¹ Not available with M Sport models.

² Only available with M Sport models.

³ Only available with Pure Traction Design package.

⁴ Not available with Sport seats.

⁵ Only available with Pure Fusion Design package.

⁶ Only available with Sport seats.

Please note that individual interior elements may differ from the interior colour, depending on the selected upholstery colour.

Interior colour.



Black

Interior trims.



■ 4CG Satin Silver, matt



□ 4AD Brushed Aluminium



□ 4MW Carbon Aluminium¹



□ 4CE Finition Anthracite wood, High-gloss



□ 4FE Metal Weave²



□ 4E0 Finition Brown wood³

□ 7RY Pure Fusion Design package

□ 7HY Pure Traction Design package



□ B53 Sparkling Brown Metallic³



□ B44 Valencia Orange² Metallic

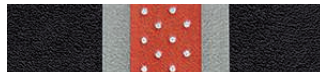

□ GUOE Black/Orange/Black²
Extended Alcantara/leather combination



□ 4E0 Finition Brown wood³



□ 4FE Metal Weave²



□ GUOF Black/Orange²
Extended Alcantara/leather combination

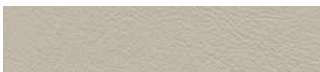

□ NAEW Ivory White
Exclusive Nappa leather³



□ GMOE Black/Orange/Black²
Alcantara/leather combination

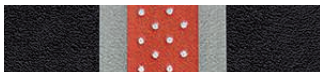

□ GMOF Black/Orange²
Alcantara/leather combination

Combinations.

	BMW upholstery colours													
	Panama cloth	Kansas leather				Extended Kansas leather				Exclusive Nappa leather³	Alcantara/leather combination²	Extended Alcantara/leather combination²		
Standard seats	•	•	•	•	•	•	•	•	•	—	—	—	—	—
Sport seats	—	•	•	•	•	•	•	•	•	•	•	•	•	•
Upholstery colour	Anthracte	Black	Canberra Beige	Coral Red	Walnut	Black	Canberra Beige	Coral Red	Walnut	Ivory White	Black/Orange	Black/Orange	Black/Orange	Black/Orange
Interior colour	Black	Black	Black	Black	Black	Black	Black	Black	Black	Black	Black	Black/Orange	Black	Black/Orange

BMW exterior colours

300 Alpine White, non-metallic	•	•	•	•	•	•	•	•	•	•	•	•	•	•	•
668 Jet Black, non-metallic⁴	•	•	•	•	•	•	•	•	•	•	•	•	•	•	•
A61 Crimson Red, non-metallic⁴	•	•	•	•	•	•	•	•	•	•	•	•	•	•	•
475 Black Sapphire, metallic	•	•	•	•	•	•	•	•	•	•	•	•	•	•	•
A76 Deep Sea Blue, metallic	•	•	•	•	•	•	•	•	•	•	•	•	•	•	•
B39 Mineral Grey, metallic	•	•	•	•	•	•	•	•	•	•	•	•	•	•	•
A75 Melbourne Red, metallic¹	—	•	•	•	•	•	•	•	•	•	•	•	•	•	•
B44 Valencia Orange, metallic²	—	—	—	—	—	—	—	—	—	•	•	•	•	•	•
A83 Glacier Silver, metallic	•	•	•	•	•	•	•	•	•	•	•	•	•	•	•
B53 Sparkling Brown, metallic³	—	—	—	—	—	—	—	—	—	•	•	•	•	•	•
A96 Mineral White, metallic	•	•	•	•	•	•	•	•	•	•	•	•	•	•	•

BMW interior trim

4CG Satin Silver, matt	•	•	•	•	•	•	•	•	•	—	—	—	—	—	—
4AD Brushed Aluminium	•	•	•	•	•	•	•	•	•	—	—	—	—	—	—
4MW Carbon Aluminium¹	•	•	•	•	•	•	•	•	•	—	—	—	—	—	—
4CE Finition Anthracite wood, High-gloss	•	•	•	•	•	•	•	•	•	—	•	•	•	•	•
4FE Metal Weave²	—	—	—	—	—	—	—	—	—	—	•	•	•	•	•
4E0 Finition Brown wood³	—	—	—	—	—	—	—	—	—	•	•	•	•	•	•

• Recommended colour combination — Not available

¹ Only available with M Sport models.
² Only available with Pure Traction Design package.
³ Only available with Pure Fusion Design package.
⁴ Not available with M Sport models.

Please note that even normal long or short-term use can lead to unrecoverable upholstery damage. This can be caused in particular by non-colourfast clothing.

Standard / Optional equipment.



■ **Xenon Headlights**, for high and low beam, with automatic headlight range control, headlight washing system, welcome light and daytime driving lights.
 □ **524 Adaptive Headlights** improve visibility by following the angle of the front wheels, giving better illumination of the road through corners.



□ **313 Exterior mirrors, folding** enables drivers to fold in both exterior mirrors (for example in a car wash) at the touch of a button and automatic dipping function for front passenger side mirror when reverse is selected.
 □ **431 Rear-view mirror, automatically dimming** senses bright headlights from vehicles behind and automatically dims to prevent light distraction whilst driving at night (standard on sDrive28i, 35i and 35is).



□ **5AC High-beam Assistant** automatically switches between high and low beam when there is oncoming traffic or another car ahead or when the road is sufficiently illuminated.
 □ **521 Rain sensor with automatic headlight activation** automatically switches on the windscreen wipers when it begins to rain, adjusting the wiper frequency in line with rainfall intensity and automatic headlight activation in the rain, at dusk and in tunnels (standard for sDrive20i, 28i, 35i and 35is).



■ **Side indicators with LED technology.**



■ **Retractable Hard-top**, with two-piece remote opening control in key, operational at speeds up to 20mph.
 □ **387 Wind deflector**, enhances the enjoyment of open-top driving by reducing buffeting. Can be folded and stored in the luggage compartment.



□ **563 Extended lighting** with vicinity lighting in the exterior door handles for safe access in the dark. Footwell lights and exit lighting also included.



□ **2FT 17" light alloy V-spoke style 514** with 8J x 17 with 225/45 R17 front and 255/40 R17 rear run-flat tyres.



■ **2S3 17" light alloy Star-spoke style 290** with 8J x 17 with 225/45 R17 run-flat tyres (standard on sDrive18i and 20i).



□ **2S5 18" light alloy Multi-spoke style 293** with 8J x 18 225/40 R18 front and 8.5J x 18 255/35 R18 rear run-flat tyres.



□ **2FU 18" light alloy V-spoke style 515** with 8J x 18 225/40 R18 front and 8.5J x 18 255/35 R18 rear run-flat tyres.



□ **2KW 19" light alloy V-spoke style 296** with 8J x 19, 225/35 R19 front and 9J x 19 255/30 R19 rear run-flat tyres.



■ **2S4 18" light alloy Star-spoke style 295** with 8J x 18 225/40 R18 front and 8.5J x 18 255/35 R18 rear run-flat tyres (standard on and only with sDrive35is).



■ **2MU 18" M light alloy Star-spoke style 325 M** with 8J x 18 225/40 R18 front and 8.5J x 18 255/35 R18 rear run-flat tyres (standard on M Sport models).



□ **2MV 19" M light alloy Double-spoke style 326 M** with 8J x 19 225/35 R19 front and 9J x 19 255/30 R19 rear run-flat tyres.

Standard / Optional equipment.

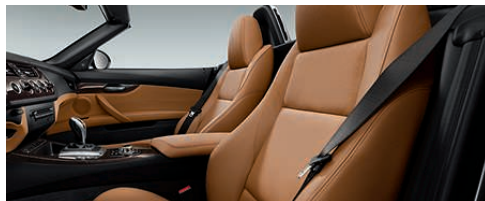

□ **481 Sport seats**, for driver and passenger, with manual adjustment of fore/aft position, seat height, backrest and seat angle, and thigh support; the electrically adjustable seat sides provide optimal lateral support (standard for M Sport and Z4 sDrive35is).

□ **488 Lumbar support**, for driver and passenger, electrically adjustable for height and depth, for an ergonomically perfect seat position and support for back muscles.

■ **Armrest, front centre**, with large storage compartment.



■ **Standard seats** with fixed integrated headrests and wide range of fore/aft adjustment as well as individually adjustable seat height and backrest angle.

□ **459 Seat adjustment, electric with memory**, for driver and passenger seats, with two memory positions for the driver's seat and mirror position memory for both exterior mirrors.

□ **494 Seat heating** for driver and passenger (three settings): seat surface, backrest and sides are heated and quickly radiate comfortable warmth.



□ **2TB Sport automatic transmission**, eight-speed with manual override, integrated with Drive Performance Control for faster gear changes. Includes uni-directional gearshift paddles on the Sport leather steering wheel (available for the sDrive18i, 20i, 28i).

□ **2TC Seven-speed Double Clutch Transmission (DCT)** for particularly fast gear changes without break in the flow of power, operated electronically or through the paddles on the leather steering wheel; for optimal dynamism and excellent fuel efficiency (standard for the Z4 sDrive35is, optionally available for the Z4 sDrive35i).



■ **Six-speed manual transmission** for a very sporty drive. Smooth, with perfect ratios and precise, short-throw gearshifts. The tight spacing of gear ratios mean that you can make even more individual use of the engine power (not available for the Z4 sDrive35is).



■ **Drive Performance Control** allows you to easily switch between Comfort, Sport, and Sport+ modes for individual choice of driving style.

□ **2VF Adaptive M Sport suspension**, lowers the vehicle height by 10mm and electronically adjusts the dampers, boosts agility and impresses with precise responses. Comfort, Sport or Sport+ modes can be selected via the Drive Performance Control button (standard for sDrive35is).



□ **2XA Sport leather steering wheel with uni-directional gearshift paddles** for even sportier gear changes in conjunction with an automatic transmission.



■ **Sport multi-function leather steering wheel**, with integrated multi-function buttons.



□ **Multi-function buttons** on Sport leather steering wheel, for operating the telephone, voice and audio functions as well as the cruise control.



■ **M Sport leather steering wheel** including M gear lever knob with M designation (only in conjunction with six-speed manual transmission).

□ **7XA M leather steering wheel with uni-directional gearshift paddles** for even sportier gear changes in conjunction with an automatic transmission (standard for Z4 sDrive35is).

□ **248 Steering wheel heating** quickly warms up the steering wheel rim at the touch of a button.



■ **BMW Professional radio** (shown above): with single CD player (MP3 playback facility) plus two-line display for expanded representation of telephone numbers, names and audio/MP3 titles, direct telephone operation via radio station buttons.

■ **DAB tuner** offers a large selection of digital radio stations with perfect sound quality.



■ **Air conditioning system, manual, single-zone** including microfilter. Ensures comfortable climatic conditions in the vehicle interior at any time of the year. Manual temperature control and air recirculation, seven-speed blower and knee-level vent.

□ **534 Air conditioning, automatic with two-zone control** (shown above), with temperature controls for driver and passenger, fan control with Max Cool button, personal profile, automatic air recirculation (AAR), filter, temperature and fan controls, solar and humidity sensors.

Standard / Optional equipment.



□ **677 Loudspeaker system - BMW Professional** 650W multi channel digital amplifier, 14 loudspeakers and digital equaliser which perfectly adapts the sound to the cabin environment.



□ **6AR Internet**, as part of Media package, enables full web browsing with content shown in the Control Display with the iDrive acting as the mouse.



□ **601 TV function** for access to digital TV channels shown in the Control Display, when the vehicle is stationary.



□ **ZNP Media package - BMW Professional**, including BMW Professional Multimedia Navigation system with 8.8" folding Control Display, built in hard disc drive and 12GB storage for audio files. Other features include: BMW Online Services for local information such as weather and Online Search; BMW Apps interface which enables your iPhone to be integrated in the Control Display for easy



access to social media such as Facebook and Twitter, also web radio access; Remote Services for remote control of specific vehicle functions; Information Plus; Enhanced Bluetooth telephone preparation with USB audio interface and Voice Control; and Real Time Traffic Information for accurate up-to-date congestion reports.



■ **Storage options** are provided by the compartment behind the seats, a folding compartment in the dashboard for vehicles without Navigation system, under the centre console, door pockets, glove box and luggage compartment.



■ **Bluetooth hands-free facility with USB audio interface** enables wireless connection of Bluetooth mobile telephones and can be operated via the iDrive controller.¹

¹ For information on compatible devices see www.bmw.com/bluetooth

Standard / Optional equipment.



□ **4UT Through-loading system with integrated transport bag** provides plenty of space for expanding the luggage compartment, including a ski rest for the boot's loading sill. With this option, even larger items such as a second golf bag (46") can be easily accommodated. You will even be able to transport two pairs of skis (max. 170 cm), with the hardtop up or down.



■ **Luggage compartment**, with an extremely practical capacity of 180 litres (hardtop down) or 310 litres (hardtop up). When the hardtop is closed, there is space for a full-size golf bag.



□ **493 Extended storage** includes two cup holders in the centre console, a folding compartment on the drivers side, nets on the backrest rear panel and passenger footwell, a clothes hook on each side and straps in the luggage compartment. Storage compartment between bulkhead (pictured) also included when not in conjunction with Through-loading feature with integrated transport bag.



□ **322 Comfort Access** for keyless access to driver and passenger doors and luggage compartment, also includes keyless starting of the engine and remote opening/closing of the Retractable Hard-top.



□ **BMW Service Inclusive.** Service costs are another area where your BMW Dealer can offer you an intelligent solution. With BMW Service Inclusive, routine maintenance service will be provided at no extra cost for the agreed duration or mileage. For more information visit:
www.bmw.co.uk/serviceinclusive

Genuine BMW Accessories.



19" light alloy Star-spoke style 276, rear bike carrier, lockable.



Drinks holder affixes to the centre console and accommodates containers of up to 1.0 litre.



Progressive floor mats and Aluminium pedals.



Black kidney grille emphasises the sporty look of the BMW Z4.

A BMW always delivers a special driving experience and can be enhanced further with Genuine BMW Accessories. The extensive product range includes accessories for the exterior, interior, mobile communications and luggage carrying solutions. All Genuine BMW Accessories have one thing in common, they are innovative ideas executed with design flair and are underpinned by BMW technology and quality. A brochure containing the full range of Genuine BMW Accessories is available from you local BMW Dealer. For further information, please visit

➔ www.bmw.co.uk/accessories

		Z4 sDrive18i	Z4 sDrive20i	Z4 sDrive28i	Z4 sDrive35i	Z4 sDrive35is ¹
--	--	--------------	--------------	--------------	--------------	----------------------------

Weight

Unladen EU ²	kg	1470 [1495]	1470 [1495]	1475 [1495]	1580 [1600]	1600
Max. permissible	kg	1725 [1750]	1725 [1750]	1730 [1750]	1835 [1855]	1855
Permitted load	kg	330	330	330	330	330
Permitted axle load front/rear	kg	795/975	800/970	800/970	870/1000	870/1000

Engine^{3,6}

Cylinders/valves		4/4	4/4	4/4	6/4	6/4
Capacity	cc	1997	1997	1997	2979	2979
Stroke/bore	mm	90.1/84.0	90.1/84.0	90.1/84.0	89.6/84.0	89.6/84.0
Output/engine speed	kW/rpm	115/5000	135/5000	180/5000–6000	225/5800	250/5900
	hp/rpm	156/5000	184/5000	245/5000–6000	306/5800	340/5900
Max. torque/engine speed	Nm/rpm	240/1250–4400	270/1250–4500	350/1250–4800	400/1300–5000	450/1500
Compression ratio	:1	10.0	10.0	10.3	10.2	10.2

Transmission

Standard transmission ratios						
	II/III:1	3.68/2.06/1.31	3.68/2.06/1.31	3.68/2.06/1.31	4.06/2.40/1.58	4.78/3.06/2.15
	IV/V:1	1.0/0.81/0.68	1.0/0.81/0.68	1.0/0.81/0.68	1.19/1.0/0.87	1.68/1.39/1.20
	VI/VIII:1	–3.35 [3.30]	–3.35 [3.30]	–3.35 [3.30]	–3.68 [4.45]	1.0/4.45
Final drive ratio	:1	3.73 [3.08]	3.73 [3.08]	3.08 [3.73]	3.08 [2.56]	2.56

Performance

Top speed	mph/kmh	137 [137]/221 [220]	146 [144]/235 [232]	155/250 ⁴	155/250 ⁴	155/250 ⁴
Acceleration 0–62mph (100km/h)	sec	7.9 [8.1]	6.9 [6.9]	5.7 [5.5]	5.2 [5.1]	4.8

Fuel consumption^{3,6}

Urban	mpg/l/100km	31.7 [30.1]/8.9 [9.4]	31.7 [30.1]/8.9 [9.4]	31.0 [30.1]/9.1 [9.4]	21.1 [21.9]/13.4 [12.9]	21.9/12.9
Extra-urban	mpg/l/100km	50.4 [53.3]/5.6 [5.3]	50.4 [53.3]/5.6 [5.3]	53.3 [51.4]/5.5 [5.3]	39.8 [41.5]/7.1 [6.8]	41.5/6.8
Combined	mpg/l/100km	41.5 [41.5]/6.8 [6.8]	41.5 [41.5]/6.8 [6.8]	41.5 [41.5]/6.8 [6.8]	30.1 [31.0]/9.4 [9.1]	31.0/9.1
CO ₂ emissions	g/km	159	159	159	219 [211]	211
Tank capacity, approx.	l	55	55	55	55	55

Wheels

Tyre dimensions	front	225/45 R17 W	225/45 R17 W	225/45 R17 W	225/45 R17 W	225/40 R18 W
	rear	225/45 R17 W	225/45 R17 W	225/45 R17 W	255/40 R17 W	255/35 R18 W
Wheel dimensions		8J x 17	8J x 17	8J x 17	8/8.5J x 17	8/8.5J x 18
Material		Light alloy	Light alloy	Light alloy	Light alloy	Light alloy

Electrical system

Battery capacity	Ah	70	70	80	70	70
Alternator output	A	170	170	170	170	170
	W	2380	2380	2380	2380	2380

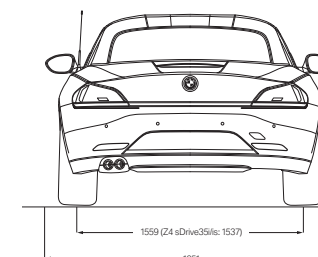
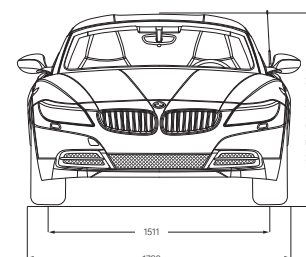
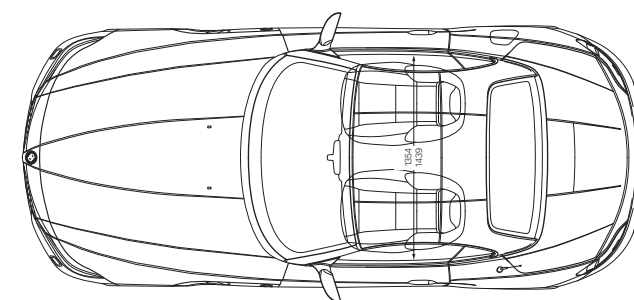
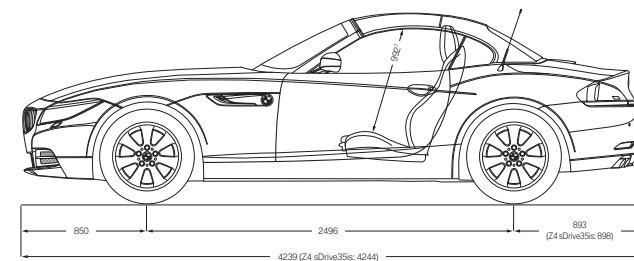

All dimensions in millimetres. Luggage compartment volume 180 litres (hardtop down) to 310 litres (hardtop up).

¹ Seven-speed Double Clutch Transmission (DCT) as standard.

² The figure quoted includes a 90% tank filling, 68kg for the driver and 7kg for luggage. Unladen weight applies to vehicles with standard equipment. Optional equipment may increase this figure.

³ The BMW Z4 engines are designed for RON 95 fuel. They may be run on lower fuel grades down to RON 91, with a decrease in power. Engines may also be run on unleaded fuel (minimum RON 91) with a maximum ethanol content of 10% (E10). Output and fuel consumption figures apply to RON 98 fuel.

⁴ Short-term peak torque with overboost function: 500Nm.

⁵ Electronically limited.

⁶ All engines comply with the EU6 emissions standard. Fuel consumption is determined in accordance with the ECE driving cycle (93/116/EC) made up of approximately one-third urban traffic and two-thirds extra-urban driving (based on the distance covered). CO₂ emissions are measured in addition to fuel consumption. Optional equipment can increase these figures. For further information on fuel consumption and CO₂ emissions please contact your BMW Dealer.

⁷ Maximum height when opening the hardtop: 1,800mm.

Values in [] apply to vehicles with automatic transmission.

Condition Based Service. A key feature in most BMW models, Condition Based Service (CBS) signals an innovative leap forward in BMW Service diagnostic technology. The way it works is simple. CBS uses sensors to constantly monitor the areas of your BMW that are subjected to wear and tear. Based on the results of the data, CBS decides the extent to which servicing is necessary. This information is then stored in your vehicle's key. Using a KeyReader, BMW Service staff can download information to provide an accurate analysis of your vehicle. This means your BMW goes for a service only when it needs to, saving you an immeasurable amount of both time and money.

Service Intelligence. BMW Approved Technicians are experts in the use of diagnostic equipment, which quickly identifies if and why the vehicle is running at anything less than peak efficiency. This leads to rapid identification and rectification.

Service Assurance. For additional peace of mind, take comfort in the fact that every new BMW is covered by a three-year warranty³ that includes BMW Emergency Service throughout Europe. For more information on BMW Service, please contact your local BMW Dealer, BMW Service Authorised Workshop or visit www.bmw.co.uk/service or www.bmw.ie



TAILOR-MADE FOR YOUR VEHICLE. BMW SERVICE.



BMW Service Inclusive. Wouldn't it be good to know your comprehensive servicing costs in advance? Well, that's exactly what BMW Service Inclusive¹ provides and for a low one-off payment.

BMW Service Inclusive¹ lasts for 5 years or 50,000 miles (whichever occurs first) and covers all your vehicle's comprehensive servicing requirements. Alternatively you can choose BMW Service Inclusive¹ Plus, which in addition to servicing also covers maintenance items such as brake pads, brake discs and windscreen wipers. And whenever servicing and maintenance work is carried out on your BMW, you can be sure that it will only be done by fully qualified BMW Service Approved Technicians at one of over 150 BMW Service Authorised Workshops around the country. Furthermore, only Genuine BMW Parts are used – each covered by a two year warranty.

BMW Service Inclusive and Service Inclusive Plus are transferable to subsequent owners within the time and mileage period, which can enhance the resale value of your car.²

¹ Service Inclusive and Service Inclusive Plus are available as cost options. Terms and conditions apply, for full details speak to your dealer or visit

www.bmw.co.uk/serviceinclusive

² For further information, please contact your local BMW Dealer.

³ Every new BMW registered within the Republic of Ireland is covered by a two-year manufacturer's warranty – for details, please contact your local BMW Dealer.



BMW ConnectedDrive Services. Function using the built-in BMW SIM card to provide telematic and online services that are fully integrated into your BMW vehicle. All services require connection to a UK mobile network. Some services are available in other European countries. The range of ConnectedDrive Services that are available depends on the specification of the vehicle. The service duration varies depending on the ConnectedDrive Service.

For further information on BMW ConnectedDrive Services and terms and conditions please visit www.bmw.co.uk/connecteddrive-information



BMW Emergency Service. BMW Emergency Service is the only roadside and assistance programme designed specifically for BMW vehicles offering an exceptional range of benefits and services. It is available 24 hours a day, 7 days a week and utilises a dedicated fleet of BMW Approved Technicians, equipped with Genuine Parts and tools, ensuring that you and your vehicle receive the best possible care in the event of any motoring emergency. This tailor-made programme has been specifically designed to meet the needs of BMW drivers travelling in the UK, Republic of Ireland and Continental Europe giving complete reassurance and peace of mind. Every new BMW is covered for three years.



BMW Financial Services. BMW Financial Services offers a range of solutions designed to help you drive the BMW of your choice. All our products offer you the flexibility to customise your finance, making driving away a BMW a reality. After all, who knows more about financing your BMW than BMW.

If you would like more information, visit www.bmwfs.co.uk. Here, you will also find details of our comprehensive range of products engineered for every eventuality.

You can view all of our current offers at the touch of a button using the BMW Financial Services Offers App. Download it now for free.



**BMW
FINANCIAL
SERVICES.**

Finance is subject to status and available to over 18's in the UK only (not the Channel Islands or the Isle of Man). Guarantees and indemnities may be required. Advertised finance is provided by BMW Financial Services, Bartley Way, Hook, Hampshire RG27 9UF.



BMW Magazine. Every new BMW customer receives a complimentary subscription to BMW Magazine. This publication features all the latest news and developments from BMW, together with a variety of driving and lifestyle features.

BMW News. To ensure you're one of the first to hear the latest BMW news and developments, BMW UK offer an email programme. Sign-up at www.bmw.co.uk/newsletter



BMW World, an iconic building in the Munich skyline. The BMW World is a true brand experience where it's possible to marvel at the historic BMWs in the museum, learn about our engineers' newest innovations and take a tour of the plant to experience with your own eyes the cutting-edge and exacting methods used to create a BMW.

SHAPING THE FUTURE – RESPONSIBLY.

The BMW Group has been ranked the most sustainable automotive company worldwide in the Dow Jones Sustainability Index for the sixth time in a row. Sustainability is an integral part of our value chain: from the development of efficiency and alternative vehicle concepts to environmentally-friendly production processes and recycling. Our research and development philosophy BMW EfficientDynamics delivers tangible benefits to customers, our climate and the environment. This is reflected in the reduction of CO₂ emissions by around 30% since 1995 within our European fleet of new cars.

Because vehicle manufacturing requires a lot of water, we have developed intelligent circulation systems for our plants to recycle it as often as possible. We have already achieved our goal of zero waste water production at our engine plant in Steyr where, in 2008, 733,500 engines were manufactured without any waste water.

Sustainability is a key concern for the BMW Group. This is why we rely primarily on environmentally friendly means of transportation such as rail and ships. For instance, we cover approximately 15.8 billion tonne-kilometres annually transporting materials and new vehicles and 79%

of the entire volume is conveyed by sea. This eases the burden on roads and the environment. The BMW Group is always looking to the future, so your BMW is part of an extensive recycling concept where every vehicle can be recycled easily and economically. To hand back your end-of-life vehicle, please contact your BMW Dealer. Further information is available at:

www.bmw.com/recycling
www.bmw.co.uk/EfficientDynamics

More about BMW

www.bmw.co.uk
www.bmw.ie



The Ultimate
Driving Machine



The models illustrated in this brochure show the specifications and configurations (standard and optional equipment) of vehicles produced by BMW AG for the German market. According to the specific requirements of other markets, alterations in standard and optional equipment and the configurations available for the different models, as described in this brochure, may occur. For more precise information about country-specific vehicle versions, please contact your local BMW Dealer. Subject to change in design and equipment. March 2014.

Part number 94 231 148 900.

© BMW AG, Munich/Germany. Not to be reproduced wholly or in part without written permission of BMW AG, Munich.

BMW recommends  **EDGE**

