

FORD ECOSPORT



Go Further



Visionary. Ingenious. Remarkable.
Every car bears his signature.

Henry Ford



Unlock extra content online. Use an appropriate app on your smartphone or tablet to scan the QR codes in this brochure.



360°



High driving position. High ground clearance.

With its high driving position giving outstanding visibility, the EcoSport lets you see more of what's going on around you. Add to that increased ground clearance, and you can make easy work of potholes and puddles.

More fun!



“Call Dad”

“Shuffle”

“Read message”

“Call office”

“Play album Greatest Hits”



“Call Chris”

“Call home”

“List mobile apps”

“What’s playing?”

Use your voice like another pair of hands.

Ford SYNC with AppLink* lets you play music, make and receive hands-free calls, read out text messages and even control apps on your smartphone. In the event of a collision Ford Emergency Assistance† communicates with the Emergency services directly providing co-ordinates of the incident and allowing occupant control at all times. (Standard)



*Compatible mobile phone required. You can browse a list of AppLink-compatible apps from www.Ford.co.uk, or via the App Catalog available in iOS and Android stores. SYNC AppLink is not supported by all European languages.

†Ford Emergency Assistance is an innovative SYNC feature that uses a Bluetooth®-paired and connected mobile phone to help vehicle occupants initiate a direct call to the local Communications Centre, following a vehicle crash event involving an airbag deployment or fuel pump shut off. The feature operates in more than 40 European countries and regions. SYNC and Emergency Assistance is not supported by all European languages. See www.ford.co.uk for the latest information.

Control at your fingertips

Within the EcoSport's quiet and sophisticated interior lies an array of technologies, all of which are easy to control. The **multifunction steering wheel** lets you control the audio system (Standard). And once you've set the **Electronic Automatic Temperature Control** (EATC), it takes care of the interior temperature, ensuring it remains at the level you've set, no matter how the weather changes outside. (Standard on Titanium, Titanium S and as part of the optional Winter Pack)





Ford EcoBoost. Sub 1-litre International Engine of the Year 2016.

With direct petrol injection, turbocharging and variable valve timing, Ford EcoBoost engines deliver power and torque consistent with larger displacement engines. The result is remarkable performance* from such an economical engine. Winner at the International Engine of the Year Awards for five years running, the 1.0 EcoBoost is available for the EcoSport in the 125 PS and 140 PS versions.



*For fuel, performance and emissions data see page 42

Powered by **FORD EcoBoost**



Life: it's about
getting the most out of it.

Find extra pleasure in the small details.

Ford KeyFree System - includes keyless entry and Ford Power Starter Button

Start the car and lock or unlock the doors without ever holding the key. Just keep the key fob with you in your pocket or bag. (Standard on Titanium and Titanium S)



Zetec

Key Exterior Features

- 16" alloy wheels
- LED signature lights
- Silver-finish front grille
- Front fog lights with integrated day running lights

Key Interior Features

- Radio/CD with USB connectivity, AUX input and Ford SYNC with Emergency Assistance*
- Manual air conditioning
- Remote central locking
- Multifunctional leather steering wheel - adjustable for rake and reach
- Power front and rear windows
- Trip computer
- Thatcham alarm
- Electrically-operated door mirrors
- Driver's seat armrest
- Courtesy lights with theatre-style dimming
- 60:40 split-folding rear seats (see page 35)
- Electronic Stability Programme (ESP)
- Tyre Pressure Monitoring System (TPMS)

Engines:

- Petrol:
 - 1.0 EcoBoost (125 PS)
 - 1.5 Duratec (112 PS)
- Diesel:
 - 1.5 Duratorq TDCi (95 PS)

*Ford Emergency Assistance is an innovative SYNC feature that uses a Bluetooth®-paired and connected mobile phone to help vehicle occupants initiate a direct call to the local Communications Centre, following a vehicle crash event involving an airbag deployment or fuel pump shut off. The feature operates in more than 40 European countries and regions. See www.ford.co.uk for the latest information.



Rear parking distance sensors

An audible warning helps you to safely judge parking distances. (Option)



16" 6x2-spoke alloy wheel



Rear-view camera

Selecting reverse gear activates the rear-view camera, allowing you to see objects behind the car through your display. (Option - Requires Sony navigation system. Not available in combination with spare wheel)





Titanium

Key Exterior Features additional to Zetec

- 17" alloy wheels
- Silver roof rails
- Chrome-finish front grille and fog lights
- Silver lower-bumper lip front and rear
- Front threshold plates - Stainless steel with 'EcoSport' logo

Key Interior Features additional to Zetec

- Partial leather seats
- Ford KeyFree system - includes keyless entry and Ford Power Starter Button
- Electronic Automatic Temperature Control (EATC)
- Cruise control
- Automatic headlights
- Rain-sensing wipers
- Auto-dimming rear-view mirror

Engines:

- Petrol:
 - 1.0 EcoBoost (125 PS)
 - 1.5 Duratec (112 PS)
- Diesel:
 - 1.5 Duratorq TDCi (95 PS)



Partial leather seats
(Standard)



17" 5x2-spoke Machined alloy wheel
(Optional as part of the Style Pack)





Titanium S

Key Features additional to Titanium

- 17" black alloy wheels
- Sports suspension
- Contrast black painted roof
- Contrast black painted mirror housings
- Rear privacy glass
- Sony radio with DAB and Ford SYNC with Emergency Assistance*

Engines:

Petrol:

1.0 EcoBoost (125 PS)

1.0 EcoBoost (140 PS)

Diesel:

1.5 Duratorq TDCi (95 PS)



Painted black roof



Sony radio with DAB and Ford SYNC

*Ford Emergency Assistance is an innovative SYNC feature that uses a Bluetooth®-paired and connected mobile phone to help vehicle occupants initiate a direct call to the local Communications Centre, following a vehicle crash event involving an airbag deployment or fuel pump shut off. The feature operates in more than 40 European countries and regions. See www.ford.co.uk for the latest information.



Wheels



16" 6x2-spoke alloy wheel
(Standard on Zetec)



17" 5x2-spoke Machined alloy wheel
(Available as part of the Style Pack on Titanium)



17" 5-spoke alloy wheel in Sparkle Silver
(Standard on Titanium)



17" 7x2-spoke alloy wheel finished in silver
(Standard on Titanium)

Wheel availability	Zetec	Titanium	Titanium S
Alloy – 16", 6x2-spoke, Sparkle Silver (Fitted with 205/60 tyres)*	●	-	-
Alloy – 17", 5x2-spoke Sparkle Silver (Fitted with 205/50 tyres)*	-	●	-
Alloy – 17", 5x2-spoke Machined finish (Fitted with 205/50 tyres)*	-	○	-
Alloy – 17", 7x2-spoke (fitted with 2015/50 tyres)*	-	-	●
16" temporary steel spare wheel (limited to 50mph top speed) – Included in tyre carrier	○	○	-
Rear-mounted outside tyre carrier (includes 16" temporary steel spare wheel) – Not available with rear-view camera	○	○	-
Locking wheel nuts – Running and spare tyre	●	●	●

● = Standard, ○ = Optional, at extra cost.
*The wheel you choose will be fitted with the tyre size noted, but no choice of tyre brand is available.



Headlights with LED signature lighting

Chrome-finish front grille*

Front fog lights with chrome surround*

*Chrome elements on Titanium and Titanium S only.

Exterior features

	Zetec	Titanium	Titanium S
Exterior design features			
Door mirrors – Body colour housing, electrically-operated, with integrated side indicator	●	●	-
Door mirrors – Body colour housing (in black), electrically-operated, with integrated side indicator	-	-	●
Front upper grille – Silver-finish	●	-	-
Front upper grille – Chrome-finish	-	●	●
Front lower grille – Silver-finish	●	-	-
Front lower grille – Chrome-finish	-	●	●
Front bumper – Body colour with dark valance	●	●	●
Rear bumper – Body colour with dark valance	●	●	●
Roof rails – Silver-finish	○	●	-
Roof – Contrast colour (painted in black)	-	-	●
Rear privacy glass	○	○	●
Style Pack - Includes rear privacy glass and 17" machined alloy wheels	-	○	-
Exterior convenience features			
Headlights – Halogen with LED signature lights	●	-	-
Headlights – Automatic headlights, halogen with LED signature lights	-	●	●
Front fog lights with day running lights	●	-	-
Front fog lights with day running lights and chrome surrounds	-	●	●
Rear-view camera – Requires Sony navigation system. Not available in conjunction with spare wheel.	○	○	○
Rear parking distance sensors	○	○	○
Wipers – Front, variable intermittent	●	-	-
Wipers – Front, automatic with rain sensor	-	●	●
Wipers – Rear wash/wipe, intermittent	●	●	●

● = Standard, ○ = Optional, at extra cost.

Interior features

Interior design features	Zetec	Titanium	Titanium S
Door lever – Chrome-finish	●	●	●
Floor mats – Front and rear, carpet	●	●	●
Gearshift knob – With chrome accent (only available on automatic transmission)	●	●	-
Gearshift knob – Leather-trimmed with black insert and aluminium-finish ring (only available on manual transmission)	●	●	●
Threshold plates - Front, stainless steel with 'EcoSport' logo	-	●	●
Steering wheel – 3-spoke, leather-trimmed, remote audio controls	●	●	●
Steering column – Rake- and reach-adjustable	●	●	●

● = Standard, ○ = Optional, at extra cost, □ = Part of an option pack, at extra cost.

A place for everything

Clever storage places help keep your EcoSport interior neat and tidy.

Underseat stowage



Centre console stowage

Sunglasses holder

Cup holders

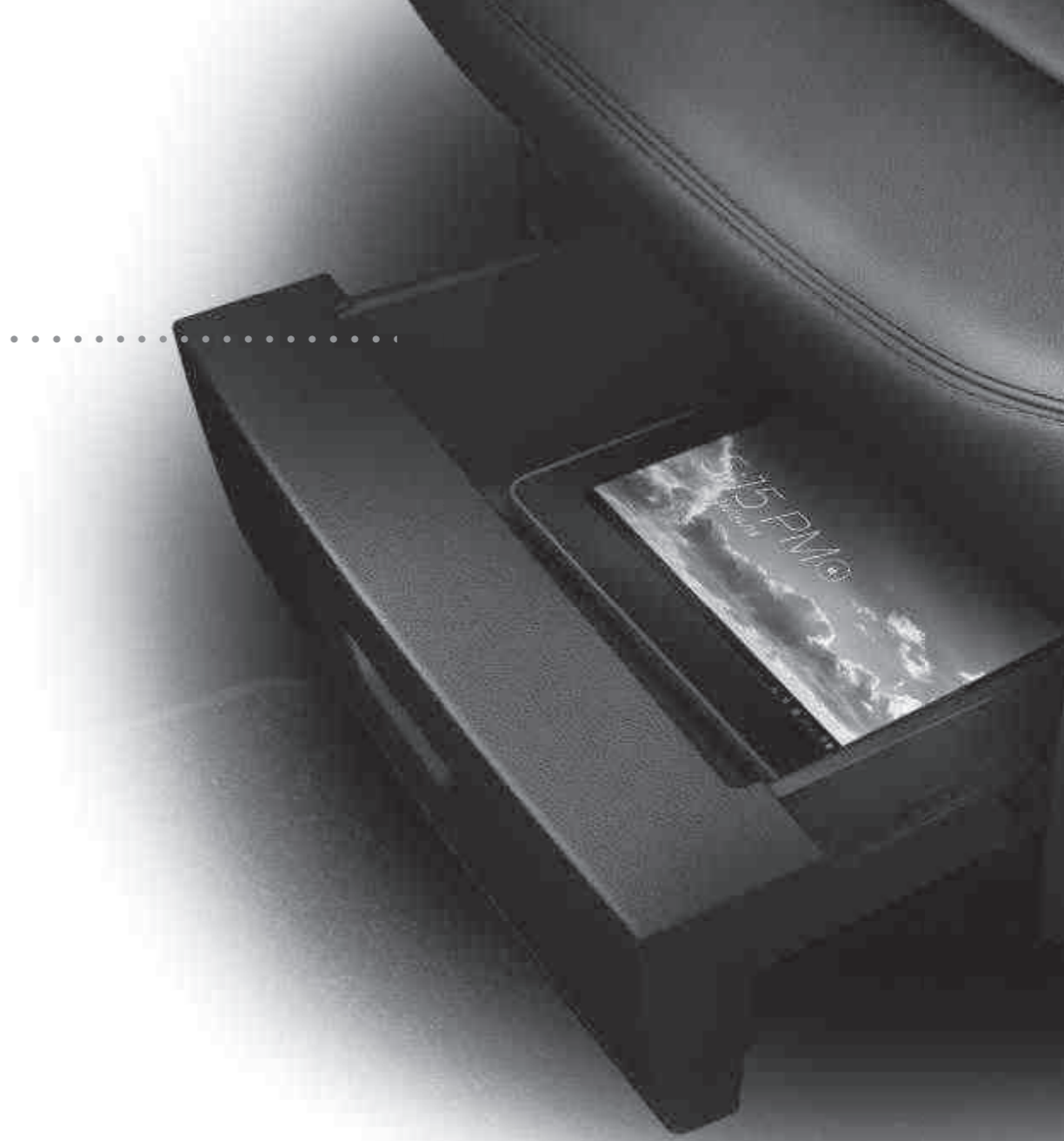

Connect with your world

A superb audio and entertainment system, with built-in connectivity for your gadgets, lets you fill your EcoSport with your favourite music and connect to the outside world.



Remote audio controls

Your hands on the wheel and your MP3 on the right track. (Remote audio controls shown on left are standard)

Audio system with Ford SYNC



USB interface

Built-in connectivity for your smartphone, MP3 player or USB stick. Lets you listen to, and operate, your player via the car's audio system.



Surround sound speaker system

Four speakers (two front and two rear) plus two tweeters give your music the intensity it deserves.





Interior features

Audio and communication systems

Radio/CD, 4.2" TFT colour display, six speakers (four front, two rear), remote audio controls, USB and AUX connections for external music devices, **Ford SYNC** – Includes Emergency Assistance*, AppLink and Voice Control.

Radio/CD with DAB, 4.2" TFT colour display, six speakers (four front, two rear), remote audio controls, diversity antenna, USB and AUX connections for external music devices, **Ford SYNC** – Includes Emergency Assistance*, AppLink and Voice Control.

Sony Radio/CD with DAB, 4.2" TFT colour display, six speakers (four front, two rear), remote audio controls, diversity antenna, USB and AUX connections for external music devices, **Ford SYNC** – Includes Emergency Assistance*, AppLink and Voice Control.

Sony Radio/CD/SD-navigation with DAB, 5.0" TFT colour display, six speakers (four front, two rear), remote audio controls, diversity antenna, USB and AUX connections for external music devices, **Ford SYNC** – Includes Emergency Assistance*, AppLink and Voice Control.

Climate control

Manual air conditioning

Air conditioning – Electronic Automatic Temperature Control (EATC)

● = Standard, ○ = Optional, at extra cost, □ = Part of an option pack, at extra cost.

*Ford Emergency Assistance is an innovative SYNC feature that uses a Bluetooth®-paired and connected mobile phone to help vehicle occupants initiate a direct call to the local Communications Centre, following a vehicle crash event involving an airbag or fuel pump shut off. The feature operates in more than 40 European countries and regions.

	Zetec	Titanium	Titanium S
Radio/CD	●	●	–
Radio/CD with DAB	○	○	–
Sony Radio/CD with DAB	–	–	●
Sony Radio/CD/SD-navigation with DAB	○	○	○
Manual air conditioning	●	–	–
Air conditioning – Electronic Automatic Temperature Control (EATC)	□	●	●

Create the perfect environment

Electronic Automatic Temperature Control (EATC)

To ensure you and your passengers enjoy the perfect in-car temperature, you can set it anywhere between 16°C and 28°C. Sensors in the car measure and maintain the selected temperature. (Standard on Titanium, Titanium S and as part of the optional Winter Pack)

Front and rear courtesy lights with theatre-style dimming

Dimming courtesy lights create an inviting atmosphere and give you time to settle in the car.

Interior features

	Zetec	Titanium	Titanium S
Interior convenience features			
Remote central locking	●	-	-
Ford KeyFree System – Keyless entry with Ford Power Starter Button (includes 2 key fobs)	-	●	●
Winter Pack – Automatic temperature control (EATC) (standard on Titanium & Titanium S), heated front seats, Quickclear heated windscreen and heated exterior mirrors	○	○	○
Courtesy lights – Front, and rear centre, with theatre-style dimming	●	●	●
Cruise Control	-	●	●
Auto-dimming rear-view mirror	-	●	●
Gear shift indicator (only available on manual transmissions)	●	●	●
Front and rear power points (12 V)	●	●	●
Windows – Front power windows with one-touch opening/closing on driver's side	●	●	●
Windows – Rear power	●	●	●
Trip computer	●	●	●
Seats			
Seats – Fabric trim	●	-	-
Seats – Partial leather trim	-	●	●
Front seat – Driver's manual lumbar support adjustment	●	●	●
Front seat – Driver's manual height, fore/aft adjustment	●	●	●
Front seat – Driver's seat armrest	●	●	●
Front seat – Passenger's fore/aft adjustment	●	●	●
Front seat – Under passenger seat stowage	●	●	●
Front seats – Seatback map pockets	●	●	●
Front seats – 2-way front head restraint up/down	●	●	●
Rear seat – 60:40 split folding seat back and cushion with multi-step recline function	●	●	●

Interior features

	Zetec	Titanium	Titanium S
Loadspace			
Tie-down hooks	●	●	●
Package tray	●	●	●

● = Standard, ○ = Optional, at extra cost, □ = Part of an option pack, at extra cost.

Tumble-fold split rear seats

Fold-down the 60:40 rear seats and you get 1,238 litres of space in the back. The seats can also tumble forward to make room for taller objects.



Smart technology

EcoSport has a range of intelligent features designed to make life a little easier and offer peace of mind.

1. Headlight courtesy delay

The headlights stay on for a few seconds to illuminate the way to your front door. (Standard)

2. Gear shift indicator

Helps to reduce fuel consumption by signalling the optimal moment to change gear. (Only available with manual transmissions)

3. Rear parking distance sensors

Audible warnings help you park in tight spaces. (Available as an option and as an accessory)

4. Ford SYNC with AppLink

The next generation of in-car connectivity. Ford SYNC lets you operate most popular MP3 players, Bluetooth®-enabled phones, USB drives, or even control apps on your smartphone with remarkably simple voice commands. Plus the Ford Emergency Assistance¹ feature is designed to assist occupants to place an emergency call in the event of an accident. (Standard)

5. Electric power-assisted steering (EPAS)

At parking speeds, full power is delivered for feather-light manoeuvring. Once you're on the move, it steadily weights up to just the right extent for optimum feel and control. (Standard)

¹Ford Emergency Assistance is an innovative SYNC feature that uses a Bluetooth®-paired and connected mobile phone to help vehicle occupants initiate a direct call to the local Communications Centre, following a vehicle crash event involving an airbag deployment or fuel pump shut off. The feature operates in more than 40 European countries and regions.

Note The Bluetooth® word mark and logos are owned by the Bluetooth SIG, Inc. and any use of such marks by Ford Motor Company Limited and its associated companies is under licence. Other trademarks and trade names are those of their respective owners.

Note It is an offence for drivers to use a hand-held mobile phone or similar device while driving.

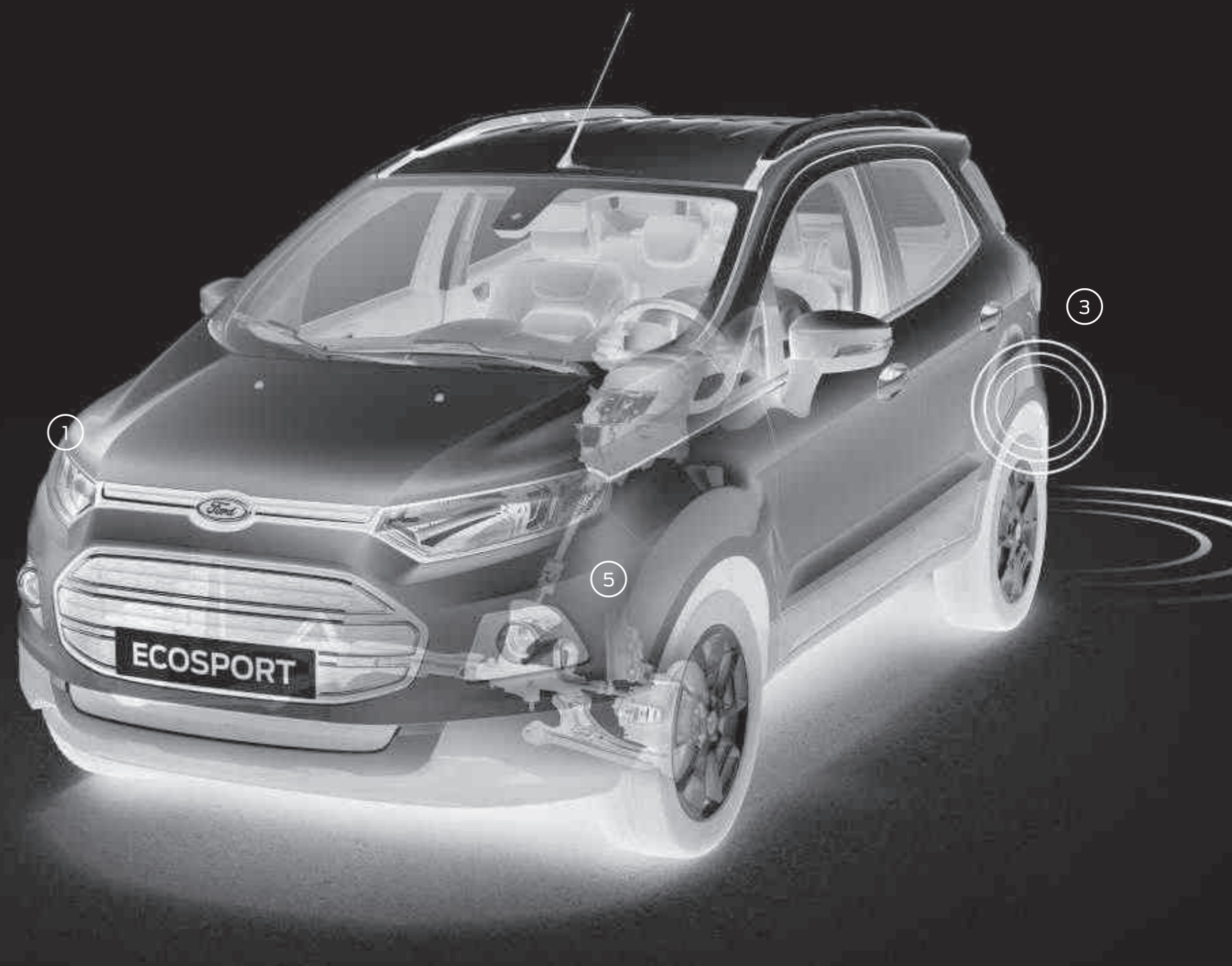

Intelligent Protection System (IPS)^{o)}

EcoSport's advanced Intelligent Protection System (IPS) uses a range of sophisticated technologies that are designed to help keep you protected, including an ultra-high-strength steel safety cage and front and side curtain airbags.

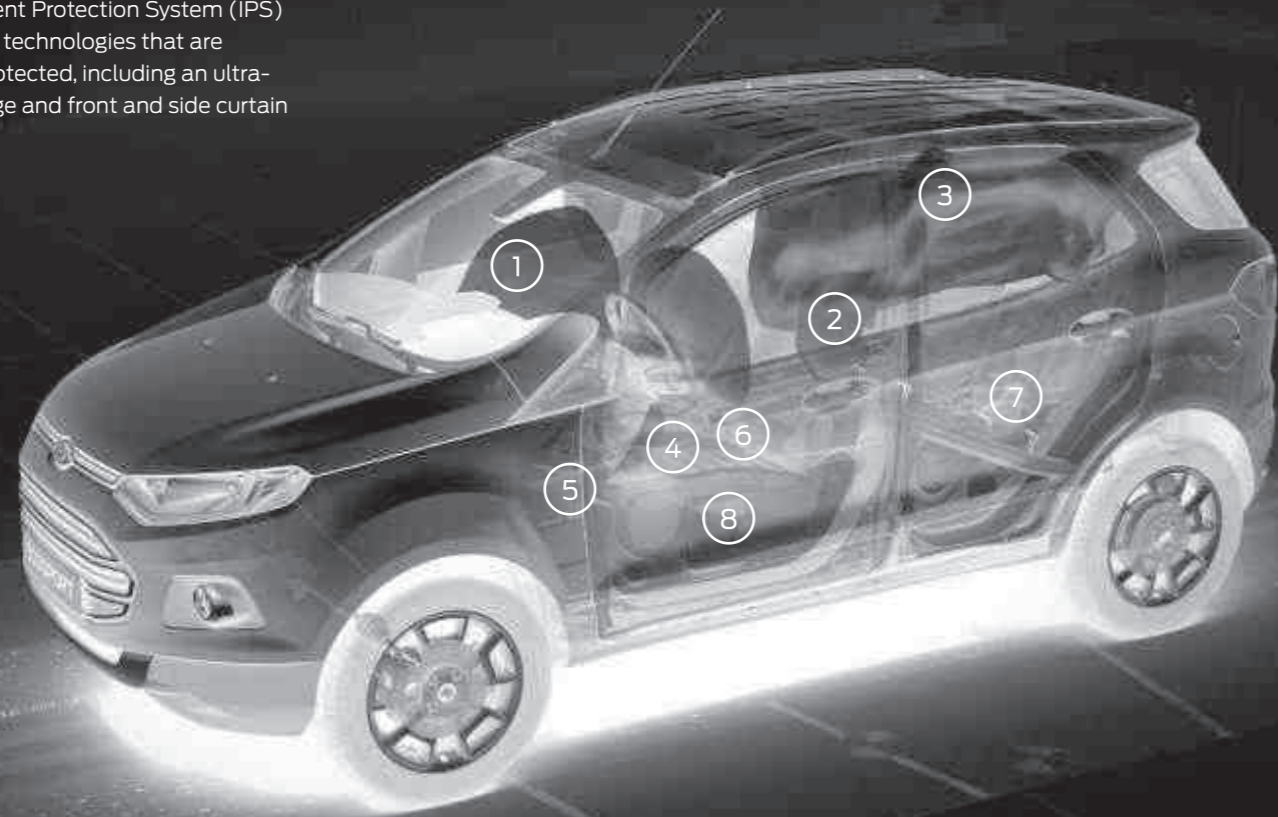

The EcoSport IPS includes:

1. Driver's and front passenger's* airbags with passenger airbag deactivation switch
2. Driver's and front passenger's side impact airbags
3. Side curtain airbags for front and rear seats
4. Driver's knee airbag
5. Robust computer-optimised body structure with ultra-rigid safety cell and crumple zones
6. Advanced lap and diagonal inertia reel seat belts on all seats. Pre-tensioners and load-limiting retractors on front seats
7. ISOFIX child seat mountings on outer rear seats
8. Anti-submarining seat bases

*Note: A rear-facing child seat should never be placed in the front passenger seat when the Ford vehicle is equipped with an operational front passenger's airbag. The safest place for children is properly restrained on the rear seat.

^{o)}Uses sensors.

Safety features

Safety and driver assistance	Zetec	Titanium	Titanium S
Intelligent Protection System (IPS) ¹⁾	●	●	●
Anti-lock Braking System (ABS) ¹⁾ with Electronic Stability Control (ESC) ¹⁾ including Brake Traction Control System (BTCS) ¹⁾	●	●	●
Hill Start Assist ²⁾	●	●	●
Airbags – Driver's and front passenger's* ¹⁾	●	●	●
Airbags – Knee (driver only) ¹⁾	●	●	●
Airbags – Front side ¹⁾	●	●	●
Airbags – Front and rear curtain ¹⁾	●	●	●
Airbags – Front passenger's de-activation switch* ¹⁾	●	●	●
Tyre Pressure Monitoring System ¹⁾	●	●	●
Seats – ISOFIX mounting provision for child seats (outer seats only) ¹⁾	●	●	●

● = Standard. ¹⁾Safety feature. ²⁾Driver assistance feature.

***Note: A rear-facing child seat should never be placed in the front passenger seat, when the Ford vehicle is equipped with an operational front passenger's airbag. The safest place for children is properly restrained on the rear seat.**

As used in the aerospace industry

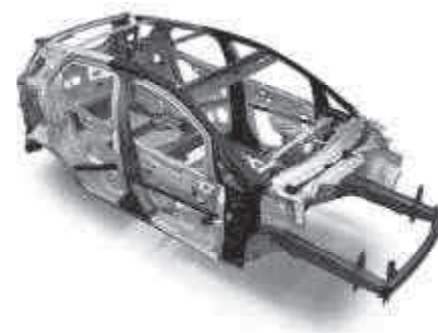

High-strength bodyshell

About half of the EcoSport's body structure is made up of high-strength and ultra-high-strength steel, such as boron steel, which is used in space programmes worldwide. This makes the bodyshell immensely strong yet lightweight.

Security features

	Zetec	Titanium	Titanium S
Security			
Child locks	●	●	●
Remote central locking	●	●	●
Thatcham alarm	●	●	●

● = Standard. ¹Safety feature, ²Driver assistance feature.

Mechanical features

	Zetec	Titanium	Titanium S
Steering			
Electric Power-Assisted Steering (EPAS)	●	●	●
Suspension			
Front – Independent with MacPherson struts and anti-roll bar	●	●	●
Rear – Semi-independent twist beam with twin gas and oil-filled shock absorbers	●	●	●

● = Standard.

PowerShift = automatic convenience + manual performance

Ford PowerShift delivers the perfect combination between automatic convenience and manual efficiency. This 6-speed automatic transmission selects the next appropriate gear at precisely the right moment for lightning-fast gear changes, with no disruption to the flow of power. The manual mode lets you switch gears at the push of a button – no clutch required. (Option on Zetec and Titanium)



Fuel, performance and emissions

The fuel economy figures quoted in the table below are achieved by following strict EU governed test procedures and are specifically designed to enable customers to compare vehicles from all manufacturers on a like-for-like basis. Fuel consumption is directly affected by the length of the journey; number of passengers and amount of luggage carried; individual driving style; road and traffic conditions; weather conditions; vehicle age, mileage, condition and standard of maintenance; use of vehicle features such as air conditioning; and any modifications to the vehicle such as the addition of a roof rack. Your fuel economy will vary based on these and other factors and, for these reasons, many drivers may not achieve the EU fuel economy figures (below) in day-to-day driving, although the vehicle is technically capable of doing so.

	Euro Stage	Trans	DriveLine	Maximum Power PS (kW)	Torque Nm	CO ₂ emissions (g/km) ^{ab}	Fuel consumption MPG (L/100km) ^{ac}			Performance ^d		
							Urban	Extra Urban	Combined	Max. speed (mph)	0-62 mph (secs)	31-62 mph* (secs)
5-Door SUV												
1.0 EcoBoost (125 PS)	Euro Stage VI	M5	4x2	125 (92)	170	125	42.8 (6.6)	60.1 (4.7)	52.3 (5.4)	112	12.7	12.8
1.0 EcoBoost (140PS)	Euro Stage VI	M5	4x2	140 (103)	180	125	42.8 (6.6)	60.1 (4.7)	52.3 (5.4)	115	11.8	12.3
1.5 Duratec (112 PS)	Euro Stage VI	M5	4x2	112 (82)	140	149	34.9 (8.1)	54.3 (5.2)	44.8 (6.3)	107	13.3	20.3
1.5 Duratec (112 PS) PowerShift	Euro Stage VI	A6	4x2	112 (82)	140	149	35.8 (7.9)	53.3 (5.3)	44.8 (6.3)	107	14.1	N/A
1.5 Duratorq TDCi (95 PS)	Euro Stage VI + DPF	M5	4x2	95 (70)	215	115	58.9 (4.8)	65.7 (4.3)	64.2 (4.4)	99	14.0	13.1

*In 4th gear. ^aFord test figures. ^{ab}The declared fuel consumptions and CO₂ emissions are measured according to the technical requirements and specifications of the European Regulations (EC) 715/2007 and (EC) 692/2008 as last amended. Fuel consumption and CO₂ emissions are specified for a vehicle variant and not for a single car. The applied standard test procedure enables comparison between different vehicle types and different manufacturers. In addition to the fuel efficiency of a car, driving behaviour as well as other non-technical factors are very important in determining a car's fuel consumption and CO₂ emissions. CO₂ is the main greenhouse gas responsible for global warming. A guide on fuel economy and CO₂ emissions which contains data for all new passenger car models is available at any point of sale free of charge or can be downloaded under <http://carfueldata.dft.gov.uk/>.

52.3mpg*

Ford EcoBoost. The small engine that thinks big.

The 1.0 litre EcoBoost is available with either 125 PS or 140 PS in the EcoSport, and delivers more power than the conventional 1.5 engine, but uses up to 16 per cent less fuel. That means a considerable saving at the petrol pump. Its improved fuel consumption is thanks to a fundamental re-engineering, resulting in a faster engine warm-up and reduced friction. *1.0 EcoBoost (125 PS/140 PS), combined cycle.

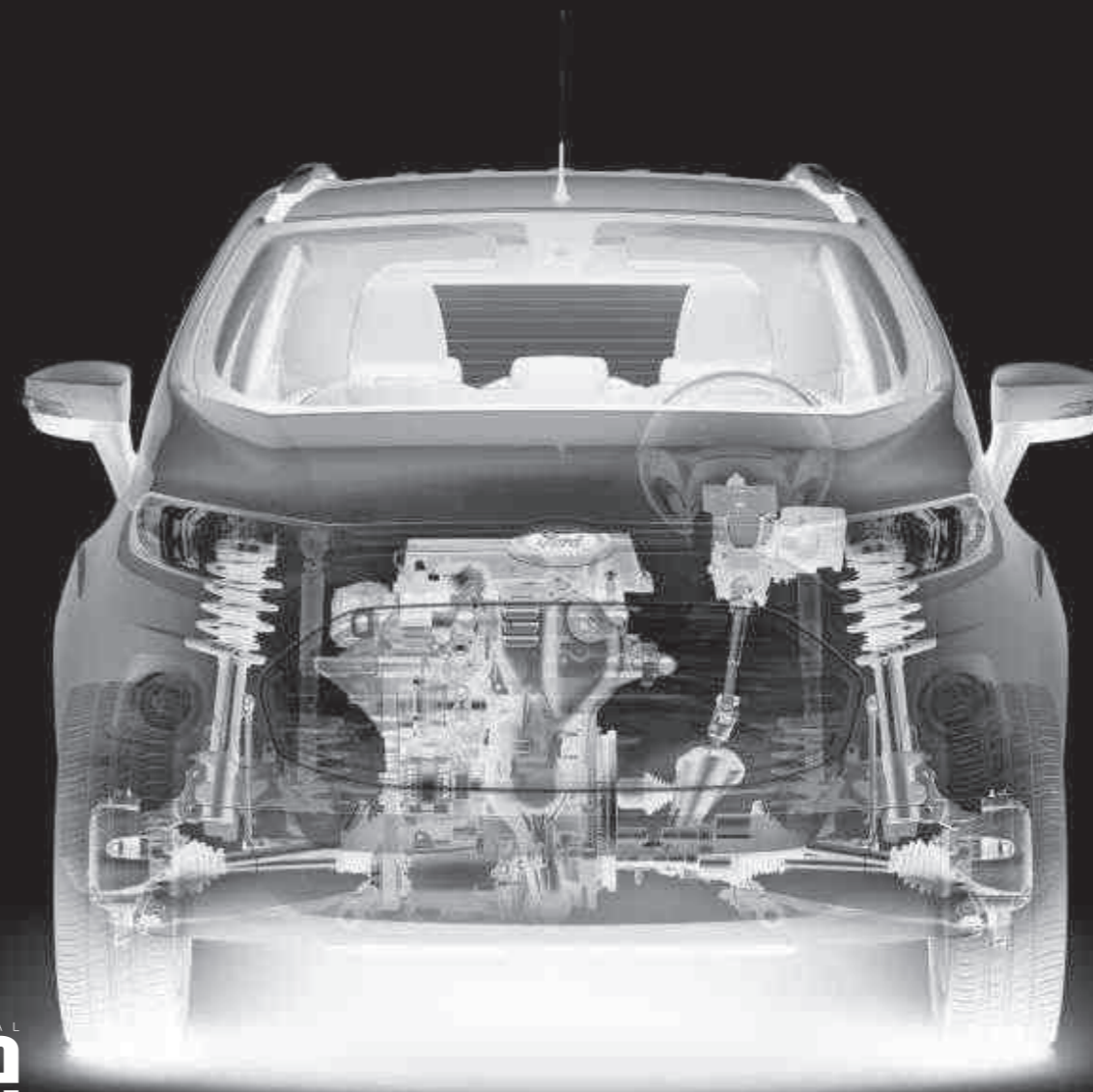

INTERNATIONAL
Engine
of the year
awards 2016
Presented by engine technology international magazine

Sub 1-litre
Ford 1.0 litre EcoBoost

Powered by **FORD EcoBoost**

Weights

5-Door SUV	Kerbweight (kg)*	Gross Vehicle Mass (kg)
1.0 EcoBoost (125 PS), Durashift 5-speed manual, 4x2	1337	1730
1.0 EcoBoost (140 PS), Durashift 5-speed manual, 4x2	1337	1730
1.5 Duratec (112 PS), Durashift 5-speed manual, 4x2	1314	1705
1.5 Duratec (112 PS), PowerShift 6-speed auto, 4x2	1350	1740
1.5 Duratorq TDCi (95 PS), Durashift 5-speed manual, 4x2	1372	1760

*Represents the lightest kerbweight assuming driver at 75 kg, full fluid levels and 90% fuel levels, subject to manufacturing tolerances and options fitted. **Nose weight limit** is a maximum of 50 kg on all models.

Flexible loadspace

Flexible space that adjusts to your needs

Fold a single rear seat and you can carry longer items and still have a passenger in the back. Or fold both rear seats flat for a full luggage load. Want more flexibility? Push the seats up again and they tumble forward to give a greater "floor-to-ceiling" space.



Thule® roof box

Designed to carry a wide variety of loads and protect them from theft and the weather. Available in various sizes, most models come with dual-opening for easy access. (Accessory)

Thule® roof bike carrier Pro Ride 591

Lightweight and easy to use. This lockable carrier is designed for frames up to 80 mm in diameter and allows you to carry your bike more securely. (Accessory)

Roof cross bars

Roof cross bars are the base for all shown roof attachments. Fixation only possible in combination with roof rails. (Accessory)



Mud flaps

Available as sets for front and rear, these practical and hard-wearing, contoured mud flaps protect the bodywork from stone chips and help to keep your Ford EcoSport clean by reducing road spray. (Accessory)

Boot liner

Moulded to fit into the Ford EcoSport. Incorporates raised edges to help keep the interior dry and clean. (Accessory)

ClimAir® wind deflector

Reduces wind turbulence and noise, allowing you a more enjoyable drive with the windows down, even during light rain whilst on the move. (Accessory)

Xvision parking distance control

An audible warning helps you safely judge the distance between your car and obstacles for easier parking and manoeuvring. (Option for rear, accessory for front and rear)

+ Item covered by third party supplier's warranty, see www.ford-accessories.co.uk for details

For more accessories for your EcoSport visit www.ford-accessories.co.uk

For a range of Ford branded items – from clothing to lifestyle products and model cars – visit www.fordlifestylecollection.com

Dimensions

	5-Door SUV
Overall length (mm)	4017
Overall length (including spare wheel) (mm)	4273
Overall width with mirrors (mm)	2057
Approach angle degree (unloaded vehicle)	21.0°
Turning circle – kerb to kerb (m)	10.6
Luggage capacity (litres)*	
5-seat mode (laden to package tray)	355
2-seat mode (laden to roof)	1238
Fuel tank capacity (litres)	
Petrol	52
Diesel	52
Interior Front	
Maximum effective headroom (mm)	1008
Maximum effective leg room (mm)	1086
Interior Rear	
Interior 2nd row headroom (mm)	971
Interior 2nd row legroom (nominal with front seat in 95% SAE position) (mm)	956

*Measured in accordance with ISO 3832. Dimensions may vary dependent on the model and equipment fitted.

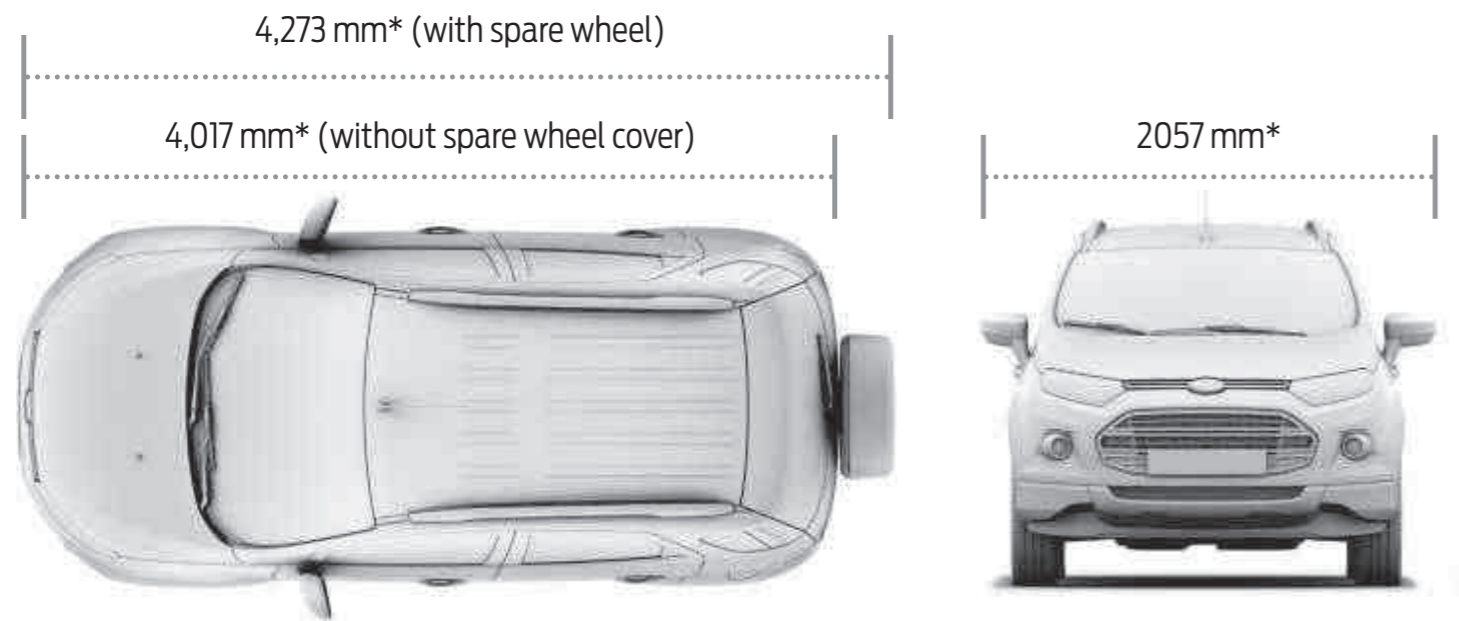

Ford Warranty and Servicing Plans

3-year/60,000 miles ¹⁾ Ford Warranty	●
1-year/unlimited mileage ¹⁾ Ford Assistance Roadside Cover (Europe)	●
2-year/2 services or 3-years/3 services ¹⁾ Ford Protect Premium Plan, including scheduled servicing and extended Ford Assistance	○
1-year/unlimited mileage ¹⁾ Paint Warranty	●
12-year/unlimited mileage ¹⁾ Perforation Warranty	●

● = Standard, ○ = Optional, at extra cost

¹⁾Whichever occurs soonest; from date of first registration. Year 1 - unlimited mileage. Subject to terms and conditions.

Colour and trim

Model	Zetec	Titanium	Titanium S
Trim	Patna fabric seat trim, Dark Shadow and Charcoal Black	Quadro partial leather seat trim, Charcoal Black	Quadro partial leather seat trim, Charcoal Black
Seat bolster trim and colour	Fabric Vigo in Charcoal Black	Capretto leather in Charcoal Black	Capretto leather in Charcoal Black
Door trim and colour	Fabric Vigo in Charcoal Black	Taurus Vinyl in Charcoal Black	Taurus Vinyl in Charcoal Black
Centre stack bezel/door handle deco strip	Graphite Anodized/Midnight Symphony	Satin Black/Midnight Symphony	Satin Black/Midnight Symphony
Upper instrument panel and Environment colour	Charcoal Black	Charcoal Black	Charcoal Black
Standard body colours			
Bright Yellow	●	●	●
Premium body colours			
Diamond White	○	○	○
Kinetic Blue	○	○	○
Moondust Silver	○	○	○
Panther Black	○	○	○
Smoke Grey	○	○	○
Exclusive body colour			
Mars Red	○	○	○

● = Available, ○ = Optional, at extra cost.

Approach angle degree (unloaded vehicle) 21.0°
 Departure angle (unloaded vehicle) 33.3°
 Ramp break over angle (unloaded vehicle) 23.3°

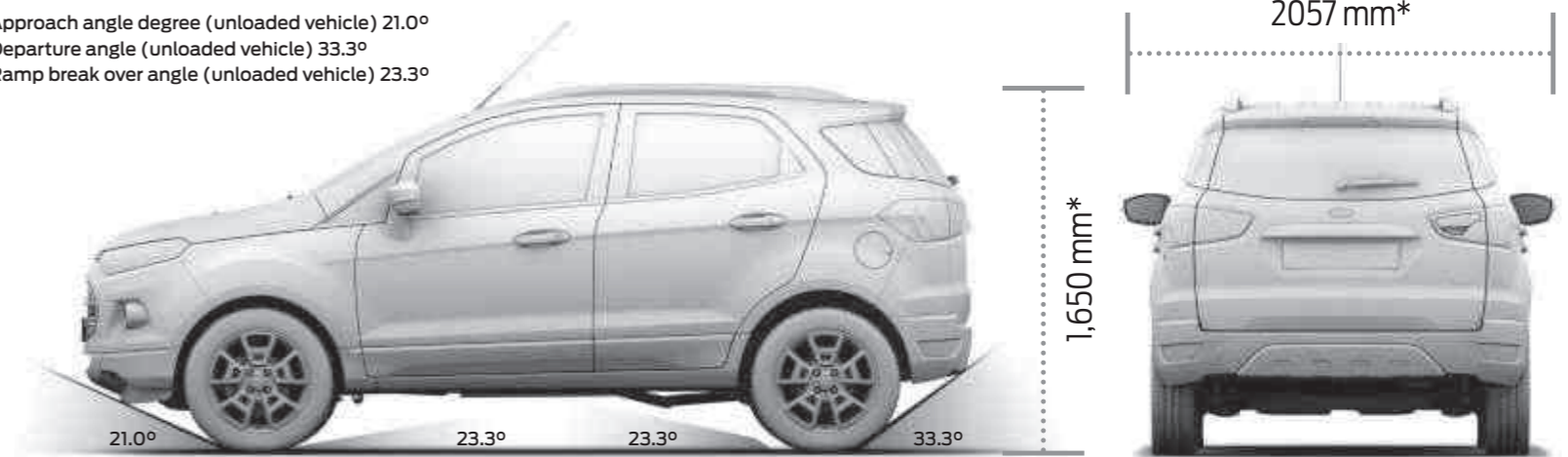



Diamond White
Premium body colour*



Panther Black
Premium body colour*



Smoke Grey
Premium body colour*

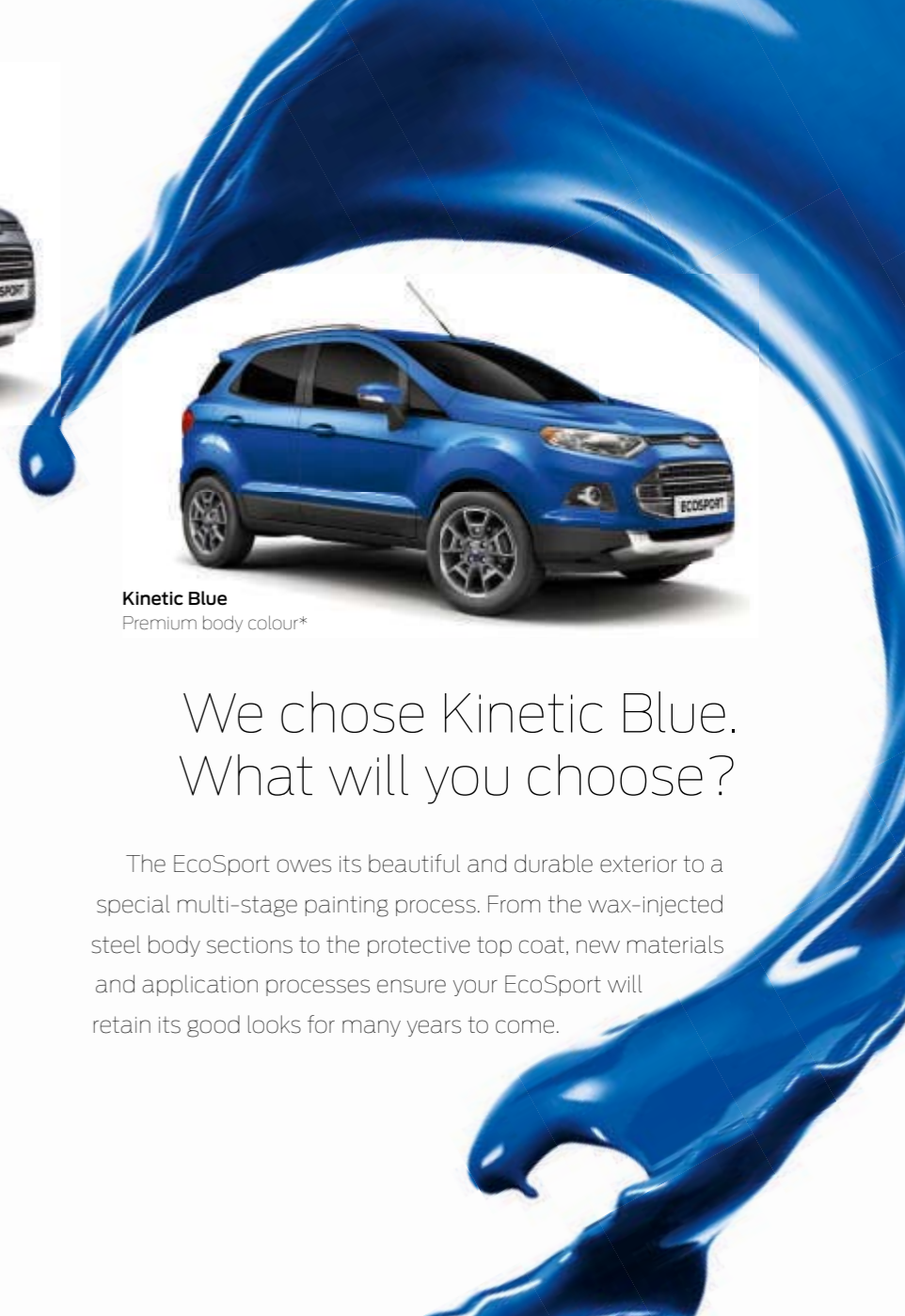

Kinetic Blue
Premium body colour*



Bright Yellow
Standard body colour



Mars Red
Exclusive body colour*



Moondust Silver
Premium body colour*

We chose Kinetic Blue. What will you choose?

The EcoSport owes its beautiful and durable exterior to a special multi-stage painting process. From the wax-injected steel body sections to the protective top coat, new materials and application processes ensure your EcoSport will retain its good looks for many years to come.

*At extra cost.

The Ford EcoSport is covered by the Ford Perforation Warranty for 12 years from the date of first registration. Subject to terms and conditions.

Note The car images used are to illustrate body colours only and may not reflect current specification or product availability in certain markets. Colours and trims reproduced within this brochure may vary from the actual colours, due to the limitations of printing processes used.

Bodystyle: _____ Series: _____

Engine: _____

Transmission: _____

Colour: _____

Trim: _____

Wheels: _____

Audio: _____

Options: _____

Option Packs: _____

Accessories: _____

Finance: _____

Choose

Specify your new car right down to the wheels, audio, options and accessories then visit your Ford dealer.

You can specify your new car online using the Ford Configurator. It lets you instantly see what your car will look like – inside and out – from multiple angles. And a tally of your choices and their prices helps you keep to your budget. Visit www.ford.co.uk/ConfigureyourCar

Finance

When it comes to financing your car, our size and expertise means we're well placed to provide you with a wide range of finance products.

Ford Credit provides a range of finance products for your car whether you are a private or business user.

Ford Lease specialises in contract hire and leasing and provides an alternative range of finance plans which can be tailored to suit your business. Business users only.

For more information about our finance products visit www.ford.co.uk

Drive

When you drive away in your new car, we're with you all the way. Ford has the largest authorised service network in the UK to help you keep your car in the best condition.

And should your new Ford ever require accident repair, a Ford Accident Repair Centre is the best place to get your car back to its pre-accident condition and on the road as quickly as possible.

Contact

Ford Credit Customer Services 0345 712 5490

Ford Lease Customer Services 0344 600 1405

Calls to 0344 and 0345 numbers are charged at the same rate as standard 01 or 02 geographic numbers, even when calling from a mobile.

To configure your Ford online visit

www.ford.co.uk/ConfigureyourCar

To look at finance for your Ford visit www.fordcredit.co.uk/BuyingAndProtectingYourFord

Business users visit www.ford.co.uk/FordFleet



Insurance Groups

	Zetec	Titanium	Titanium S
5-Door SUV			
1.0 EcoBoost (125 PS), Durashift 5-speed manual, 4x2	11E	11E	TBC
1.0 EcoBoost (140 PS), Durashift 5-speed manual, 4x2	N/A	N/A	13E
1.5 Duratec (112 PS), Durashift 5-speed manual, 4x2	9E	N/A	N/A
1.5 Duratec (112 PS), PowerShift 6-speed auto, 4x2	9E	10E	N/A
1.5 Duratorq TDCi (95 PS), Durashift 5-speed manual, 4x2	8E	10E	TBC

E = Exceeds security requirement for model concerned and group rating has been reduced. Insurance ratings are issued by the Association of British Insurers and are shown above in the new 1-50 rating scales.

Illustrations, descriptions and specifications. This catalogue was correct at the time of going to print. However, Ford policy is one of continuous product development. The right is reserved to change specifications, colours and prices of the models and items illustrated and described in this publication at any time. For the latest details always consult your Ford Dealer. **Optional equipment.** Throughout this publication, wherever a feature is described as being an 'Option' or 'Option Fitment/Pack' etc, you should assume that it will be at extra cost to the base vehicle, unless specifically stated to the contrary. All models and colour combinations are subject to availability. **Note.** Some images portrayed are of a pre-production model and/or are computer generated, therefore, the design/features on the final version of the vehicle may differ in various respects. In addition, some of the features shown on the vehicles may be optional. **Note.** This brochure contains both original Ford accessories as well as a range of products from our suppliers. **+**The identified accessories are carefully selected third party supplier branded accessories which do not come with a Ford warranty but are covered by the third party supplier's own warranty, the details of which can be obtained from your Ford Dealer. **Note.** The Bluetooth® word mark and logos are owned by the Bluetooth SIG, Inc. and any use of such marks by Ford Motor Company is under licence. The iPod word mark and logos are the property of Apple Inc. Other trademarks and trade names are those of their respective owners. **Note.** Some driver assistance features and safety features described in this brochure are designed to function using sensors, whose performance may be affected under certain weather or environmental conditions.

The Government fuel figures do not express or imply any guarantee of the fuel consumption of any particular vehicle. The vehicles themselves have not been tested and there are inevitably differences between individual vehicles of the same model. In addition, a vehicle may incorporate particular modifications. Furthermore, the driver's style and road and traffic conditions, as well as the extent to which the vehicle has been driven and the standard of maintenance, will affect its fuel consumption. **Insurance groups** are only as recommended by the Association of British Insurers. You should always consult your insurance adviser for confirmation.



Ford One Call

In the unlikely event that your Ford Dealer can't help you or if you need to speak to us directly, call 0203 5644 4444

Ford Rental - local service nationwide

Car and Van rental from our latest model range. Contact your local Ford Dealer for more information

Ford Motability

Call our Motability team on 0345 6040019

Finance

Ford Credit Customer Services 0345 712 5490
Ford Lease Customer Services 0344 600 1405
Calls to 0344 and 0345 numbers are charged at the same rate as a standard 01 or 02 geographic number, even when calling from a mobile.



Published by Ford Motor Company Limited, Brentwood, Essex, England. Registered in England No. 235446. **FA 1595/5** BUN 205458. FoE H63E. 1216/GBR en December 2016.

© Ford Motor Company Limited.

