

Ford MONDEO



Go Further



Visionary. Ingenious. Remarkable.
Every car bears his signature.

Henry Ford



Unlock extra content online. Use an appropriate app on your smartphone or tablet to scan the QR codes in this brochure.



360°



The performance figures are equally stunning.

The sleek lines of the new Mondeo cut through the air more efficiently than ever before. The trapezoid grille hides an **Active Grille Shutter** that improves airflow and reduces drag. Streamlined rear quarter panels are designed to reduce turbulence and add stability.

And when powered with the **Ford EcoBoost** engine, fuel efficiency gets even better. Ford's EcoBoost engines deliver the same performance as larger engines, but with superior fuel economy and lower emissions.*

*Please refer to the fuel economy figures shown on the Fuel, performance and emissions pages.



It makes you wish the journey was longer.

Sound absorption materials create a hushed interior, a place of harmony and control. Light pours in through the **panorama roof** to enhance the feeling of spaciousness and highlight subtle chrome detailing.

(optional feature)

In the Mondeo Titanium with optional Titanium X Pack, getting in and out of the elegant interior is made easier by the optional **powered steering column** that moves away to allow extra space. Linked to the optional **memory seat** function, it always returns to your ideal driving position.



Connects with your voice,
responds to your touch.



New **Ford SYNC 3 with Voice Control and 8" Touchscreen** offers a more sophisticated interface between driver and technology. The improved touchscreen now supports multi-touch gestures such as 'swipe' and 'pinch-to-zoom'. While Bluetooth® and USB connectivity will let you integrate SYNC 3 with your external devices, Apple CarPlay, Android Auto, Applink and Emergency Assistance¹ give complete access to your smartphone HMI through the SYNC 3 home screen.

You can also customise home screen settings by arranging application icons and background displays, just as you would on your tablet or smartphone; also switch between daytime and night modes, as well as tailor presets for multiple users.

SYNC 3's Enhanced Voice Control System lets you govern everything from interior climate to satellite navigation², and will even manage your phone calls and text messaging – all through remarkably simple voice commands.

²Satellite navigation is standard on all series (excluding Style).

¹Ford Emergency Assistance operates in over 40 European countries. This feature works when paired with a compatible connected mobile phone that is with you and switched on when an airbag is deployed or a sensor that registers a crash deactivates the fuel pump. SYNC Applink and Emergency Assistance are not supported by all European languages. See your local Ford website for latest information.

Please note: Full SYNC 3 smartphone integration only available with iPhone 5/Android 5.0 (Lollipop) or higher. Some SYNC 3 functions require a data connection, so mobile data charges will apply. To check whether Apple CarPlay and Android Auto are available in your market, please check official Apple CarPlay and Android Auto websites for the latest information. The touchscreen feature should not be used by the driver whilst driving.



"Call John"

"Listen to message"

"Find town centre"

"I need fuel"

"I need to park"

"I'm hungry"

Active Park Assist helps you find a space.



*And get in.
And get out.*

Active Park Assist can steer you into parking spaces just 20% longer or wider than the car. Simply push a button and the sensors of this innovative system locates a suitable space as you drive past. Then it automatically steers you in, while all you do is operate the accelerator, gears and brake (following on-screen instructions and audible signals). Park-out Assist helps you get out of a parallel parking space in the same way.

(Optional feature)





Bi-turbo diesel with 210 PS*

Mondeo's high-power diesel engine employs a sequential bi-turbo system for increased performance and efficiency. Its primary turbocharger delivers instant acceleration at lower speeds, while a secondary turbocharger is primed for top-end power.

Another benefit is that the vehicle warms quickly to your desired temperature on those bitterly cold winter mornings.

(*2.0 TDCI 210ps is not available on all models)





A new generation of seat belt.

Designed to reduce injuries to rear seat passengers, Ford's award-winning **rear inflatable seat belts** spread crash forces over five times more body area than conventional seat belts. This helps reduce pressure on the passenger's chest, and helps control head and neck motion. In everyday use, the inflatable belts operate like conventional safety belts, are more comfortable to wear due to their soft edges, and are compatible with booster child seats.



Intelligent All-Wheel Drive (AWD) system

Mondeo's Intelligent All-Wheel Drive system (AWD) continually monitors your driving environment, optimising traction whatever the surface by directing power to where it is needed. A special display on the cluster panel shows the power split to keep you informed about conditions beneath each wheel.

(not available on all models).

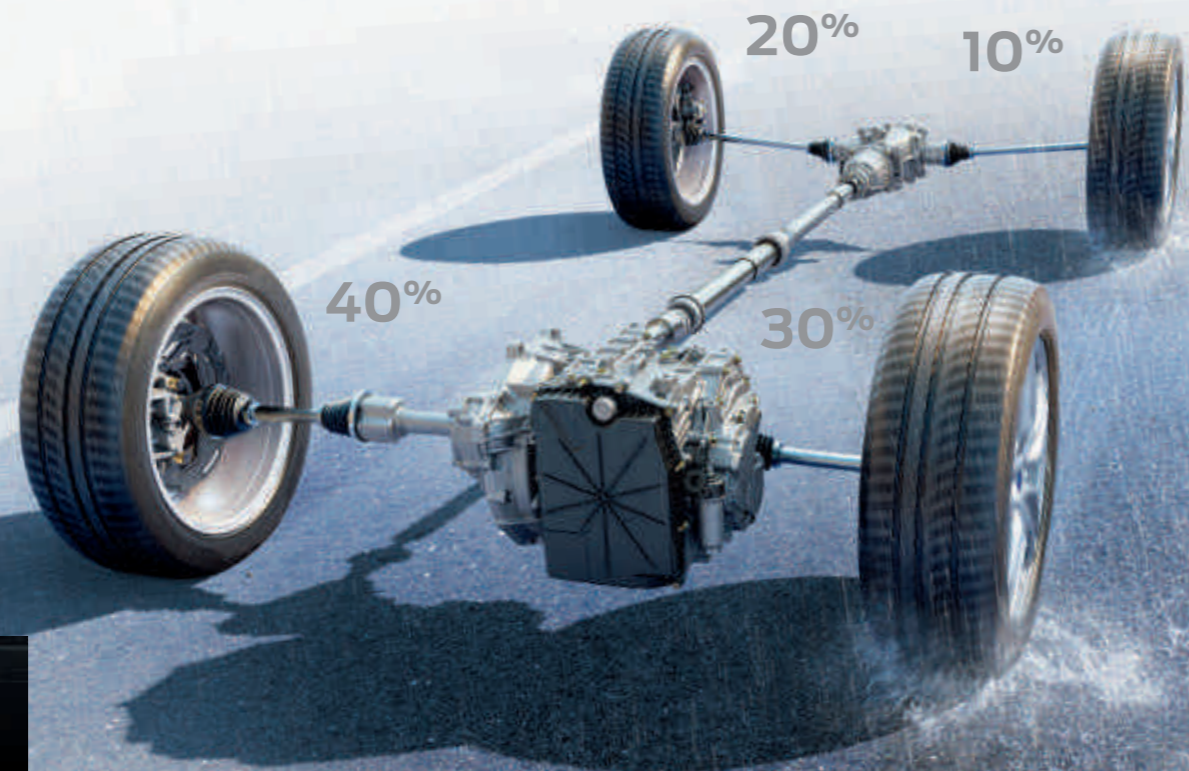

A special display on the cluster panel shows the power distribution between all four wheels. (Standard on all Intelligent All-Wheel Drive models)



The next generation of efficiency.

The **Titanium Hybrid Electric Vehicle (HEV) Mondeo** champions fuel efficiency by seamlessly switching between its electric and petrol engine.

Powered by a state-of-the-art Hybrid battery (high voltage lithium-ion technology), the traction motor operates in electric mode.

When you're accelerating at speed or overtaking, the petrol engine contributes as needed to supply extra power.

To maximise your mileage, **Smart Regenerative Charging** captures over 90% of brake energy and uses it to help recharge the battery.



Instant feedback. The more efficiently you drive, the more green leaves appear on the SmartGauge®.





A new expression of Ford.

Experience a new expression of Ford with Mondeo Vignale. Ford Vignale offers a truly unique ownership experience. The vehicles themselves shine with superior craftsmanship and attention to detail. Check our Vignale Range brochure for more information.



Ford Mondeo Vignale with optional 19" alloy wheels and Nocciola body colour, exclusive to Vignale.

Choose your Mondeo.



4-DOOR SALOON

4-Door saloon bodystyle is only available with Mondeo 2.0 187PS Titanium Hybrid Electric Vehicle (HEV), shown above in White Platinum Exclusive bodycolour (option) with 18" alloy wheels (standard), Titanium X Pack and Active Park Assist (all optional).

5-DOOR HATCHBACK

Model shown is a Mondeo Titanium 2.0TDCi 180PS 6-speed manual in Ruby Red Exclusive bodycolour (option), featuring 19" 5x2-spoke alloy wheels, Panorama roof, Active Park Assist and Titanium X Pack (all optional).

5-DOOR ESTATE

Model shown is a Mondeo Titanium 2.0 EcoBoost 240PS 6-speed automatic in Magnetic Premium bodycolour (option) with 19" 5x2-spoke alloy wheels, Active Park Assist and Titanium X Pack (all optional).



Mondeo Zetec

Standard exterior features

- 17" alloy wheels (16" alloy wheels on ECONetic models)
- Body colour front and rear lower bumper and side rocker trim
- Front fog lights & LED daytime running lights
- Halogen projector headlights
- Chrome upper grille surround, side window surrounds and roof rails (Chrome roof rails available on Estate only)
- Power-foldable door mirrors with indicator and puddle light

Standard Zetec interior features

- Ford Navigation System, DAB Audio system, Radio/CD with 8-speakers
- Ford SYNC 3 with Bluetooth, voice control, 8" colour touch screen and USB connectivity port
- Emergency Assistance
- Electrically-operated front and rear windows with global opening/closing (operated by key fob)
- Air conditioning with Dual-zone Electronic Automatic Temperature Control (DEATC)
- Cruise control with Adjustable Speed Limiter

- "Quickclear" heated front windscreen
- Leather-trimmed steering wheel
- Illumination of driver and passenger sunvisor mirrors
- Map reading lights front and rear
- Courtesy Lights with theatre-style dimming
- MyKey
- Electric Parking Brake (EPB)
- Driver and front passenger seat manual lumbar and height adjustment
- Rear seat centre armrest
- Rear seat 'Ski hatch'

Bodystyles

5-door Hatchback and Estate

Engines

Petrol:

1.0 EcoBoost 125PS, 1.5 EcoBoost 160 PS

Diesel:

ECONetic 1.5 Duratorq TDCi 120 PS and 2.0 Duratorq TDCi 150 PS (also available in ECONetic)



Mondeo ST-Line

Exterior features additional to Zetec

- 18" 5x2-spoke Rock Metallic finish alloy wheels
- Sports suspension
- Bodystyling Kit with unique design front and rear lower bumpers
- Gloss Black fog light bezels
- Body colour sports design rocker panel mouldings
- Body colour rear spoiler (standard estate, optional on 5 door)
- Black finish roof rails (wagon only)
- ST-Line badge

Interior features additional to Zetec

- Sports style front seats with red stitching
- Premium velours front and rear floor mats
- Ford Power Starter Button
- Aluminium-finish foot pedals
- Unique finish front door scuff plates
- Perforated leather-trimmed steering wheel
- Black leather-trimmed gearshift knob with embossed lettering
- Multi-colour ambient lighting

Bodystyles

5-door and Estate

Engines

Diesel:

2.0 Duratorq TDCi 150PS and 180PS.



Ford power starter button
(Standard)



Gloss Black fog light bezels
(Standard)



TITANIUM & HEV

Exterior features additional to Zetec

- 18" alloy wheels (16" alloy wheels on ECONetic models)
- Front and rear parking sensors
- High gloss lower grille with chrome detail
- Automatic headlights with Auto High/Low Beam for night driving
- Rain sensing front windscreen wipers

Note: LED Daytime running lights are located in the headlight cluster when the optional Titanium X Pack is ordered



360°

Interior features additional to Zetec

- Sports style front seats
- 10" TFT cluster display
- Lane Keeping System (includes Lane-keeping Alert and Lane-Keeping Aid)
- Traffic Sign Recognition
- Premium front and rear floor mats
- Multi-colour ambient lighting
- Rear reading lights
- Chrome finish front door scuff plates

Bodystyles

5-door Hatchback and Estate, Titanium Hybrid Electric Vehicle is only available as a 4-door saloon

Engines

Petrol:
1.5 Ford EcoBoost 160PS, 2.0 Ford EcoBoost 240PS, 2.0 TiVCT Hybrid Electric Vehicle 187PS.

Diesel:

1.5 Duratorq TDCi 120 PS ECONetic, 2.0 Duratorq TDCi 150/180PS and 210PS (150PS also available in ECONetic)



10" colour TFT cluster display
(Standard)



Lane-Keeping System
(Standard)

More of what you want.



Active Braking

Designed to detect a potential collision and automatically apply the brakes.



Ford Dynamic LED headlights

This intelligent headlight system is designed to select an appropriate beam pattern for enhanced illumination in different road conditions. When turning, the **dynamic cornering** feature throws the beam inside the curve to help you see further. And the headlight's lower edge features two LED strips: white daytime running lights, and amber indicators that flash sequentially towards the direction of turn.

(Available option)



Automatic transmission with steering wheel mounted paddle shifts

Race-inspired steering wheel-mounted paddles let you easily change gear without taking your hands off the steering wheel.

(Only available with Automatic transmissions)



Heated steering wheel

Warms up at the touch of a button to add another layer of comfort between you and the cold outside. (Option as part of Winter Pack)



Traffic Sign Recognition

Designed to automatically read standard format road signs and display the posted speed limit in the instrument cluster. (standard on Titanium)

Lane-Keeping System

Designed to recognise when you approach lane markings without using the indicator and alert you with vibrations through the steering wheel. If the system detects that an unintentional lane change is likely, it is designed to apply a steering torque back towards the lane you were in. (standard on Titanium)



Active City Stop

Designed to sense potential low-speed collisions and apply the brakes if you don't react in time for speeds up to 40 km/h. This intelligent technology could help prevent or mitigate damage from low-speed accidents.

(Available option)



Adaptive Cruise Control with Forward Alert

Part of Pre-Collision Assist. Simply enter the desired speed and distance from the vehicle in front and Adaptive Cruise Control automatically maintains the set distance if traffic conditions impede travel at the desired cruising speed. While Forward Alert offers audible and visual warnings when at risk of colliding with the vehicle in front, and Emergency Brake Assist (EBA) facilitates maximum braking performance.

(Available option)





Frozen White
Premium body colour*



Magnetic
Premium body colour*



Guard
Exclusive body colour*



Blazer Blue
Standard body colour



Moondust Silver
Premium body colour*



Deep Impact Blue
Premium body colour*



Shadow Black
Premium body colour*



Tectonic Silver
Exclusive body colour*



White Platinum
Exclusive body colour*



Ruby Red
Exclusive body colour*

We chose Ruby Red. What will you choose?

The Mondeo owes its beautiful and durable exterior to a special multi-stage painting process. From the wax-injected steel body sections to the protective top coat, new materials and application processes ensure your Mondeo will retain its good looks for many years to come.

*Premium and Exclusive body colours are options at extra cost.

Your Mondeo is covered by the Ford Perforation Warranty for 12 years from the date of first registration. Subject to terms and conditions.

Note The car images used are to illustrate body colours only and may not reflect current specification or product availability in certain markets. Colours and trims reproduced within this brochure may vary from the actual colours, due to the limitations of printing processes used.



Interior trims

The look and feel of interior materials plays a large part in appreciating the overall driving experience. That's why great care has been taken in designing and crafting the trims for the new Mondeo.



1. Cypress in Ebony with white dots in Ebony for Zetec
2. Vector in Ebony for Titanium
3. Salerno Leather in Charcoal Black for Titanium/Titanium HEV when selecting Titanium X Pack as an option.

4. Vector in Ebony with red stitching for ST-Line

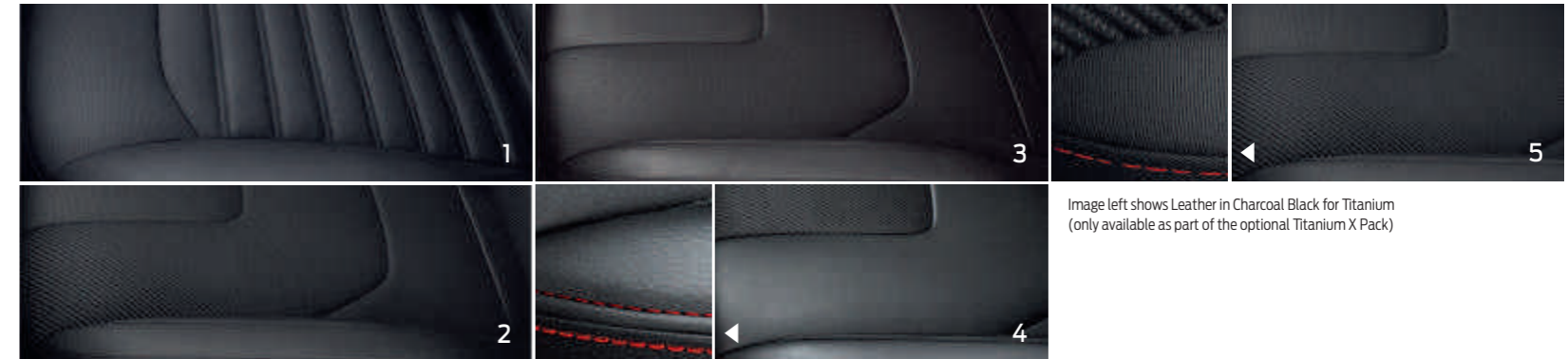

Image left shows Leather in Charcoal Black for Titanium (only available as part of the optional Titanium X Pack)



Wheels



17" alloy wheels (Accessory) 18" alloy wheels (Accessory) 18" 5-spoke alloy wheels (Standard on Titanium) 19" 5x2-spoke alloy wheels (Option on Titanium) 19" 7x2-spoke alloy wheels ST-Line and Titanium (option)



	Style	Zetec	ST-Line	Titanium	Titanium HEV
Wheels					
Alloy – 16" 10-spoke 215/60 R16 tyres (standard on TDCi ECOnetic engines)	●	●	-	●	-
Alloy – 17" 5x2-spoke 235/50 R17 tyres*	-	●	-	-	-
Alloy – 18" 5-spoke 235/45 R18 tyres*	-	-	-	●	●
Alloy - 18" Rock Metallic painted finish 235/45/R18 tyres*	-	-	●	-	-
Alloy – 19" 5x2-spoke 235/40 R19 tyres*	-	-	-	○	-
Alloy - 19" Rock Metallic painted finish 235/40/R19 tyres*	-	-	○	-	-
Alloy – 19" "Y"-spoke 235/40 R19 tyres*	-	-	○	○	-
Instant mobility system – tyre repair kit	-	-	-	-	●
Mini Spare wheel	●	●	●	●	-
Full size (16") Spare wheel	○	○	○	○	-
Locking wheel nuts – fitted to all vehicles with Alloy wheels	●	●	●	●	●

● = Standard, ○ = Optional, at extra cost, □ = Part of an option pack, at extra cost.
Note: The 18" and 19" wheels and tyres available on Ford Mondeo are designed to deliver more sporting driving characteristics and a firmer ride quality compared to 16" and 17" wheels and tyres. 16" Alloy wheels are standard with ECOnetic engines, replacing the standard specification 17" Alloys on Zetec and 18" Alloys on Titanium. * = Not available with TDCi ECOnetic and 1.5 EcoBoost engines.



The intensity and angling of Adaptive Lighting with Ford Dynamic LED headlights adjust automatically according to speed and driver input.

Adaptive Lighting with Ford Dynamic LED headlights help you see around bends and identify hidden objects. Their bright white light provides an intense and uniform illumination of the road, and the light comes much closer to natural daylight than that created by conventional halogen or xenon headlights.

Residential area lighting



City light



Country beam



Motorway light



Adverse weather beam



Manoeuvring beam



Dynamic bending



Static bending



Exterior features

Exterior design features	Style	Zetec	ST-Line	Titanium	Titanium HEV
Bodystyling Kit – Front and rear bumper lower valance, unique upper and lower grille and rocker panel moulding	-	○	●	○	-
Chrome finish to side window surrounds (Black finish in ST-Line)	-	●	-	●	●
Door mirrors – Body colour housings	●	●	●	●	●
Door mirrors – Power-operated and heated with body colour housings and side indicators	●	-	-	-	-
Door mirrors – Power-operated, heated and power foldable with body colour housings, side indicators and puddle lights	-	●	●	●	●
Front and rear upper grille – Body colour	●	●	●	●	●
Front & rear lower grille – Self colour	●	-	-	-	-
Front & rear lower grille – Body colour	-	●	●	●	●
Upper grille surround – Chrome finish	-	●	●	●	●
Lower grille – Self colour	●	●	-	-	-
Lower grille – Painted high gloss with chrome surround (includes Adaptive Cruise Control)	-	-	-	●	●
Lower grille - High gloss black finish with honeycomb mesh design	-	-	●	□	-
Front fog lights – With LED Daytime running lights	-	●	●	●	●
Front fog light bezel – Self colour	-	●	-	-	-
Fog light – Painted black with chrome ring (when optional Adaptive LED headlights are selected)	-	-	-	□	□
Rear privacy glass – Dark glass on rear windows (available within the optional Titanium X Pack)	-	○	○	○/□	○/□
Rear spoiler (not available on 4-door)(LED Daytime running lights located within headlight cluster when optional Adaptive LED headlights are selected)	-	○	●	○	-
Roof rails – Chrome finish (Estate only)	●	●	-	●	-
Roof rails - Black finish (Estate only)	-	-	●	-	-
Retractable Tow Bar with Trailer Sway Control (not available with body styling kit or on HYBRID)	○	○	○	○	-
Rocker panel mouldings – Self colour	●	-	-	-	-
Rocker panel mouldings – Body colour	-	●	●	●	●



ST-Line delivers the Ford Mondeo with the additional eye-catching aesthetics of a performance-line vehicle. Rear spoiler, bodystyling kit, Rock Metallic alloy wheels, and ST-Line exterior branding – all contribute to the car's unique blend of stylish sophistication and looks.

(Rear spoiler standard on estate only – optional on 5 door)

Exterior features

Exterior convenience features	Style	Zetec	ST-Line	Titanium	Titanium HEV
Headlights – Halogen daytime running lights	●	-	-	-	-
Headlights – LED daytime running lights (located within headlight cluster when optional Adaptive LED headlights are selected)	-	●	●	●	●
Headlights – Auto-lighting (Includes automatic high/low beam)	-	-	□	●	●
Headlights – Halogen projector headlights	●	●	●	●	●
Headlights – Adaptive LED headlights with integrated LED daytime running lights (available as part of the optional Titanium X Pack)	-	-	○	□	□
Headlights – Headlight courtesy delay, illumination for up to 120 seconds after the vehicle is locked	●	●	●	●	●
Headlights – Manual headlight levelling control	●	●	●	●	●
Parking distance sensors – Front and rear (also available with the optional Active Park Assist system)	○	○	○	●	●
Rear lights – LED technology	●	●	●	●	●
Rear-view camera - On Zetec, rear-view camera is only available with the optional front and rear parking sensors or optional Active Park Assist system	○	○	○	○	○
Wipers – Manual front windscreen wipers with variable sensitivity adjustment	●	●	●	-	-
Wipers – Automatic rain sensing front windscreen wipers with variable sensitivity adjustment	-	-	-	●	●
Winter Pack – Variable heated front seats and heated steering wheel	-	○	-	○	-
Titanium X Pack – Adaptive LED headlights with integrated LED daytime running lights, leather seats, 10-way power driver & passenger heated seats (driver seat with memory), keyless entry and rear privacy glass	-	-	-	○	○
Power Adjustable Steering Column with Memory (only available with Titanium X Pack)	-	-	-	○	○

● = Standard, ○ = Optional, at extra cost, □ = Part of an option pack, at extra cost.

Windscreen defrost

Quickclear heated front windscreen

A heated element built into the windscreen is designed to clear the glass quickly, making it ideal for frosty mornings. (Optional on Style, standard on Zetec, ST-Line, Titanium & Titanium HEV).





Rear spoiler

Give your Mondeo a sportier profile and enhanced aerodynamics. (Option and accessory - Not available on 5 door in conjunction with Power Tailgate)

Two radars monitor your blind spot

Blind Spot Information System

As another vehicle – car, van or lorry – enters your blind spot, the system is designed to alert you with a discreet warning light built into the driver's and passenger's door mirrors.

Optional on all series excluding Style.



Interior features

Interior design features	Style	Zetec	ST-Line	Titanium	Titanium HEV
Door handles – Chrome	●	●	●	●	●
Gearshift knob – Leather-trimmed	-	●	●	●	●
Gearshift knob - Leather trimmed with unique design	-	-	●	-	-
Scuff plates – Bright finish front door	-	-	-	●	●
Scuff plates - Stainless steel finish with 'ST-Line' logo	-	-	●	-	-
Steering wheel – Leather-trimmed	●	●	-	●	●
Steering wheel - Leather trimmed with unique perforated leather inserts	-	-	●	-	-

Change your perspective

Panorama roof

Enjoy the beauty of the outdoors from the comfort of your Ford Mondeo. A full-length glass panorama roof lets the sun shine in, while a solar reflect coating and powered sunblind provide shade and privacy when required.

Optional on Zetec, ST-Line and Titanium



Interior features

Audio and communication systems	Style	Zetec	ST-Line	Titanium	Titanium HEV
Ford SYNC 3 with Bluetooth®, Voice Control, 8" Touchscreen, USB connectivity port and Emergency Assistance*	●	●	●	●	●
Ford DAB Audio system, single CD, DAB Radio, AM/FM dual tuner radio with 5th channel and phased diversity, 8 speaker audio, Ford SYNC 3 with Voice Control and 8" Touchscreen, AM/FM DAB in glass antenna, FM2 diversity antenna in glass, USB port, SD card slot and GPSM	●	-	-	-	-
Ford DAB Navigation System, single CD, DAB Radio, AM/FM dual tuner radio with 5th channel phased diversity, TMC, 8 speaker audio, Ford SYNC 3 with Voice Control and 8" Touchscreen, AM/FM DAB in glass antenna, FM2 diversity antenna in glass, with USB port, SD card slot and GPS	○	●	●	●	●
Sony DAB Navigation System, single CD, DAB Radio, AM/FM dual tuner radio with 5th channel phased diversity, TMC, 12 Sony premium speakers, Ford SYNC 2 with Voice Control and Touchscreen, AM/FM DAB in glass antenna, FM2 diversity antenna in glass, with USB port, SD card slot and GPSM	-	-	-	○	○
Climate control					
Air conditioning – Dual-Zone Electronic Automatic Temperature Control (DEATC)	●	●	●	●	●
Rear compartment air-conditioning	-	●	●	●	●

● = Standard, ○ = Optional, at extra cost, □ = Part of an option pack, at extra cost.

*Ford Emergency Assistance operates in over 30 European countries. This feature works when paired with a compatible connected mobile phone that is with you when an airbag is deployed (excludes knee airbags) or a sensor that registers a crash deactivates the fuel pump. Text function and Emergency Assistance are not supported by all European languages. A compatible mobile phone is required. Please visit www.ford.co.uk for the latest mobile phone compatibility information.

One finger, dozens of choices

Touchscreen technology

You can use your voice or use your finger to easily select different controls. The four colour-coded corners offer you easy access to phone, navigation, media and climate controls. Within these lie dozens of choices to create and manage your ideal driving environment with the touch of your finger. (Touchscreen technology is standard on every Mondeo)

*Satellite navigation is standard on all series.

(Some touchscreen functions should not be used by the driver whilst driving)



Audio technology

The whisper-quiet interior of the new Mondeo is the ideal place for state-of-the-art entertainment.

Premium Sound System

Features an 8-channel amplifier and a 12 speaker system that includes a fascia-mounted tweeter and concealed sub-woofer for superb sound reproduction. The three radio tuners and two antennae work together to ensure that the best possible radio signal and traffic data is being received. Includes USB/MP3/iPod® connectivity port. (Option only available with Sony® DAB Radio Audio/CD Navigation system)

(Some touch screen functions should not be used by the driver whilst driving)

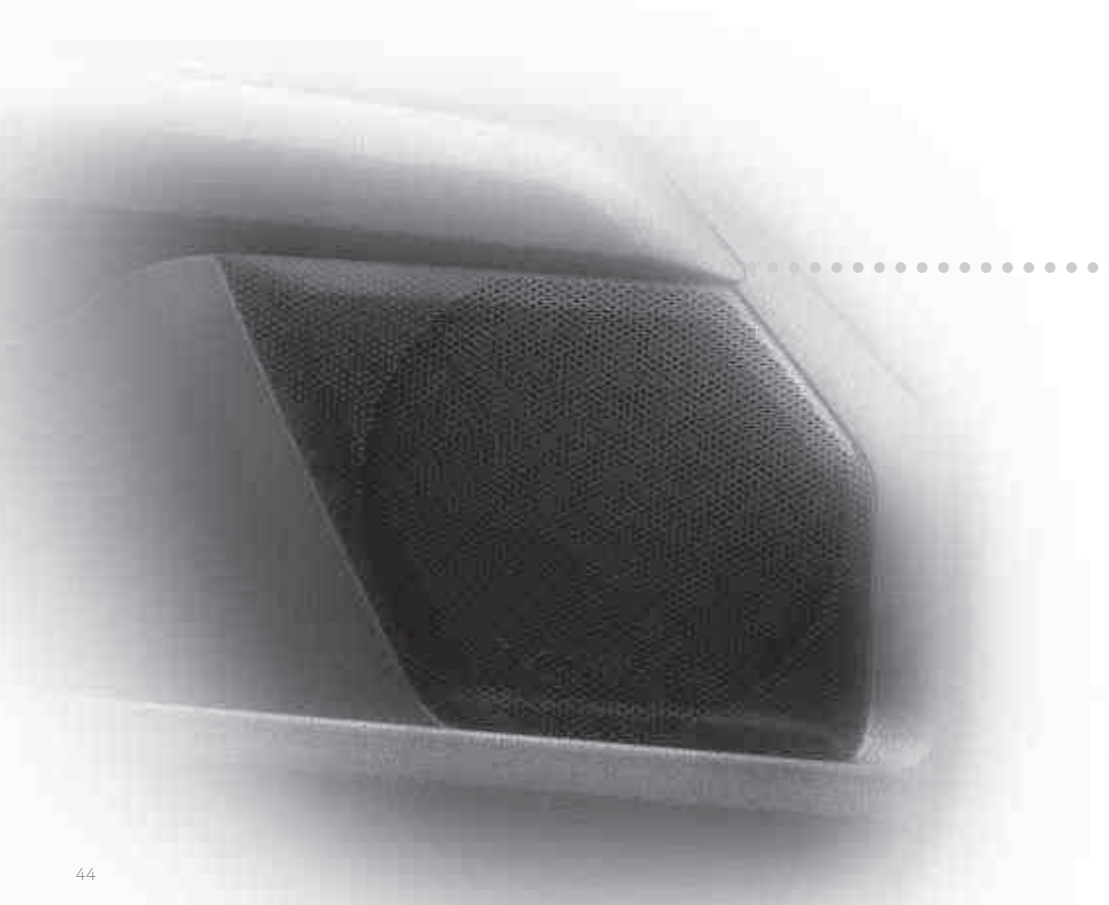



Interior features

Interior convenience features

	Style	Zetec	ST-Line	Titanium	Titanium HEV
Ford Power Starter Button (available on Zetec with optional Key Free system)	-	□	●	●	●
Cruise control	●	-	-	-	-
Cruise control – With Adjustable Speed Limiter	-	●	●	●	●
Cruise control – Adaptive Cruise control with collision mitigation and Adjustable Speed Limiter	-	-	-	○	○
Centre console – With fixed armrest, stowage and cup holders	●	●	●	-	-
Centre console – With clamshell armrest, stowage and cup holders	-	-	-	●	●
Overhead console – Short with sunglasses stowage and courtesy light (includes map lights)	-	●	●	●	●
Courtesy lights – Theatre-style dimming	-	●	●	●	●
Courtesy lights – 2nd row reading lights	-	-	-	●	●
Mirror – Auto-dimming rear-view	-	-	-	●	●
Courtesy lights – Multi-Colour ambient lighting (Front door interior release handles, front door map pockets, floor console, front/rear footwells and IP/Console pass through)	-	-	●	●	●
Stowage – Front seat back map pocket (driver & passenger)	●	●	●	●	●
Stowage – Rear seat centre armrest	●	●	●	●	●
Panorama roof – Laminated infrared, fixed glass (5-Door Hatchback only) with sun shade	-	○	○	○	-
Panorama roof – Laminated infrared, power opening/closing (Estate only) with sun shade	-	○	○	○	-
Sunroof – Power opening (Titanium HEV 4-door Saloon only) with sunshade	-	-	-	-	○
Windows – Power front with drivers/passengers one-touch lowering/closing	●	-	-	-	-
Windows – Power front and rear with global opening/closing controlled by key fob	-	●	●	●	●

● = Standard, ○ = Optional, at extra cost, □ = Part of an option pack, at extra cost.

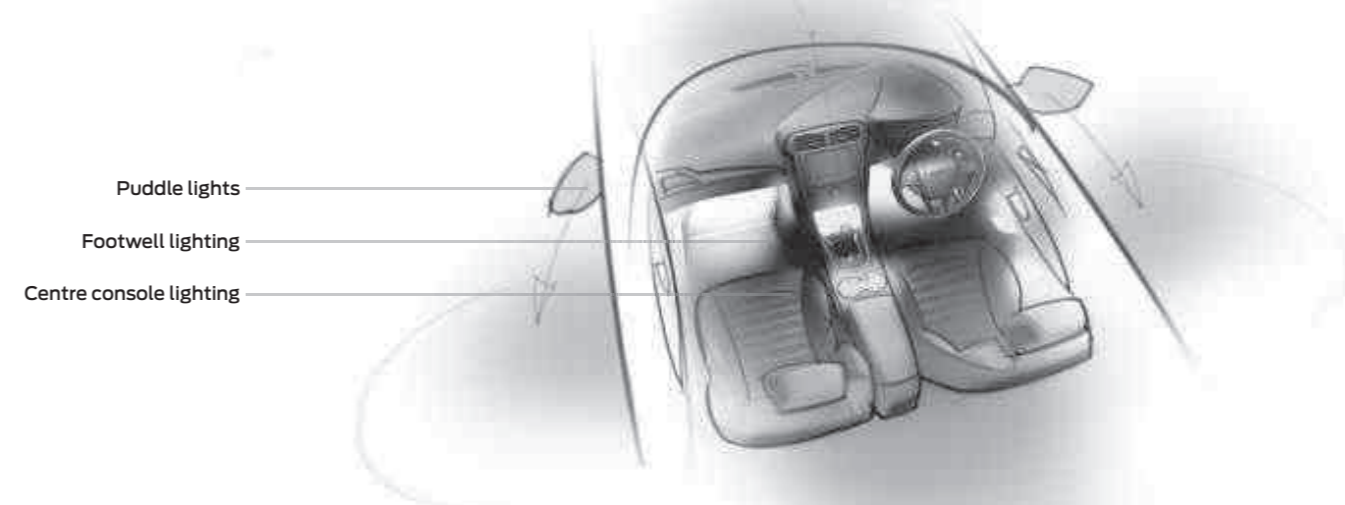

Puddle lights

Footwell lighting

Centre console lighting

Mechanical features

	Style	Zetec	ST-Line	Titanium	Titanium HEV
Steering					
Gear shift indicator light (Enabled)	●	●	●	●	●
Manual rake-and reach-adjustable steering column	●	●	●	●	●
Power Adjustable Steering Column with Memory (available in combination with Titanium X Pack only)	-	-	-	○	○
Suspension					
Sport suspension (standard with TDCi ECOnetic engines)	○	○	●	○	-
Self-levelling suspension (only available on Estate, but not in combination with with TDCi ECOnetic engines)	○	○	-	○	-
Technology					
Electric parking brake	●	●	●	●	●
Auto-Stop-Start system (Standard with all powertrains)	●	●	●	●	●

● = Standard, ○ = Optional, at extra cost.

Superior ride and handling

Ford Integral Link rear suspension system

This system has its suspension components attached via an isolated sub-frame. This is designed to deliver superior ride and handling, as well as reducing noise, vibration and harshness (NVH).

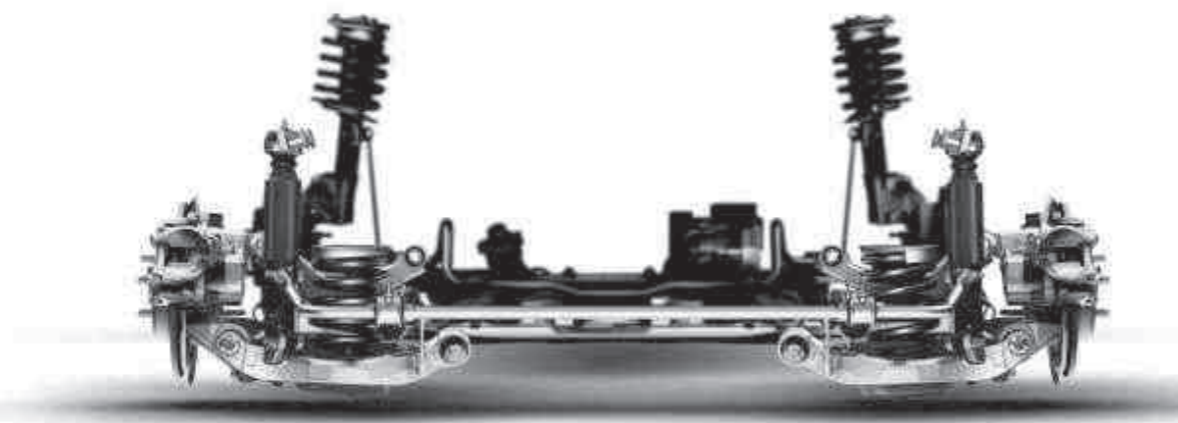

Interior features

	Style	Zetec	ST-Line	Titanium	Titanium HEV
Seats					
Front seat – Comfort style	●	●	-	-	-
Front seat – Sports style	-	-	●	●	●
Front seat – Driver side manual lumbar adjust	●	●	●	●	●
Front seat – Driver side 2-way power lumbar adjust	-	-	-	□	□
Front seat – Driver power seat recliner (power switch)	-	-	-	□	□
Front seat – Passenger side manual lumbar adjust	-	●	●	●	●
Front seat – Passenger power seat recliner (power switch)	-	-	-	□	□
Front seat – Passenger side power lumbar adjust	-	-	-	□	□
Front seat – Driver 4-way manual adjust (manual fore/aft/up/down)	●	●	●	●	●
Front seat – Driver 10-Way power adjust (power fore/aft/up/down/tilt/recline/2-way power lumbar) with memory (for track and recliner only)	-	-	-	□	□
Front seats – Variable heated driver and passenger seat (included with the optional Titanium X Pack)	-	-	-	□	□
Rear seats – 60/40 split non-sliding, Fold Flat (all bodystyles)	●	●	●	●	●
Loadspace					
Dog guard (behind second row seats, Estate only)	○	○	○	○	-
Load compartment floor hooks	●	●	●	●	●
Load Management System (Estate only) (Boot floor mounted sliding rail, D-rings & cargo net)	○	○	○	○	-
Tonneau cover (Estate only)	●	●	●	●	-

● = Standard, ○ = Optional, at extra cost, □ = Part of an option pack, at extra cost.

Active technology

1. Active City Stop (Option)

Designed to sense potential low-speed collisions and apply the brakes if you don't react in time.

2. Active Braking (Option)

Uses sensors to monitor the road ahead. When it detects a possible collision at high speed it is designed to send you a warning message on the instrument panel. If you don't react, the system applies the brakes automatically.

3. Adaptive Cruise Control (Option)

Helps maintain a preset gap between your Ford Mondeo and the vehicle ahead. If the vehicle in front slows down, the system decelerates. When the gap widens, your Ford Mondeo returns to the desired speed.

4. Blind Spot Information System (Option)

This high-tech visual aid is designed to make longer journeys a far more relaxing experience. As another vehicle – a car, van or lorry – enters your blind spot, it alerts you with a discreet warning light built into the driver's and passenger's power-foldable mirrors.

5. Driver Alert (Option, standard on Titanium & HEV)

Uses a road-monitoring camera to assess the driver's alertness levels and displays them in the instrument cluster: a steering-wheel icon represents an alert driver; a coffee cup means a break is recommended. If the driver fails to stop, the warning is repeated at regular intervals, together with a warning chime.

6. Lane Keeping Alert and Lane Keeping Aid (Option, standard on Titanium & HEV)

Designed to recognise when you approach lane markings without using the indicator, Lane Keeping Alert warns you with vibrations through the steering wheel. If the system detects that an unintentional lane change is likely to occur, Lane Keeping Aid is designed to apply a steering torque back towards the lane you were in.

7. Rear-view camera (Option)

Select reverse gear and the rear-view camera comes on automatically in the SYNC 3 touchscreen display, allowing you to see objects behind your car. For safer and easier manoeuvring, Special guidance graphics indicate the width and centre line of the car. Only available with optional front and rear parking sensors or Active Park Assist.

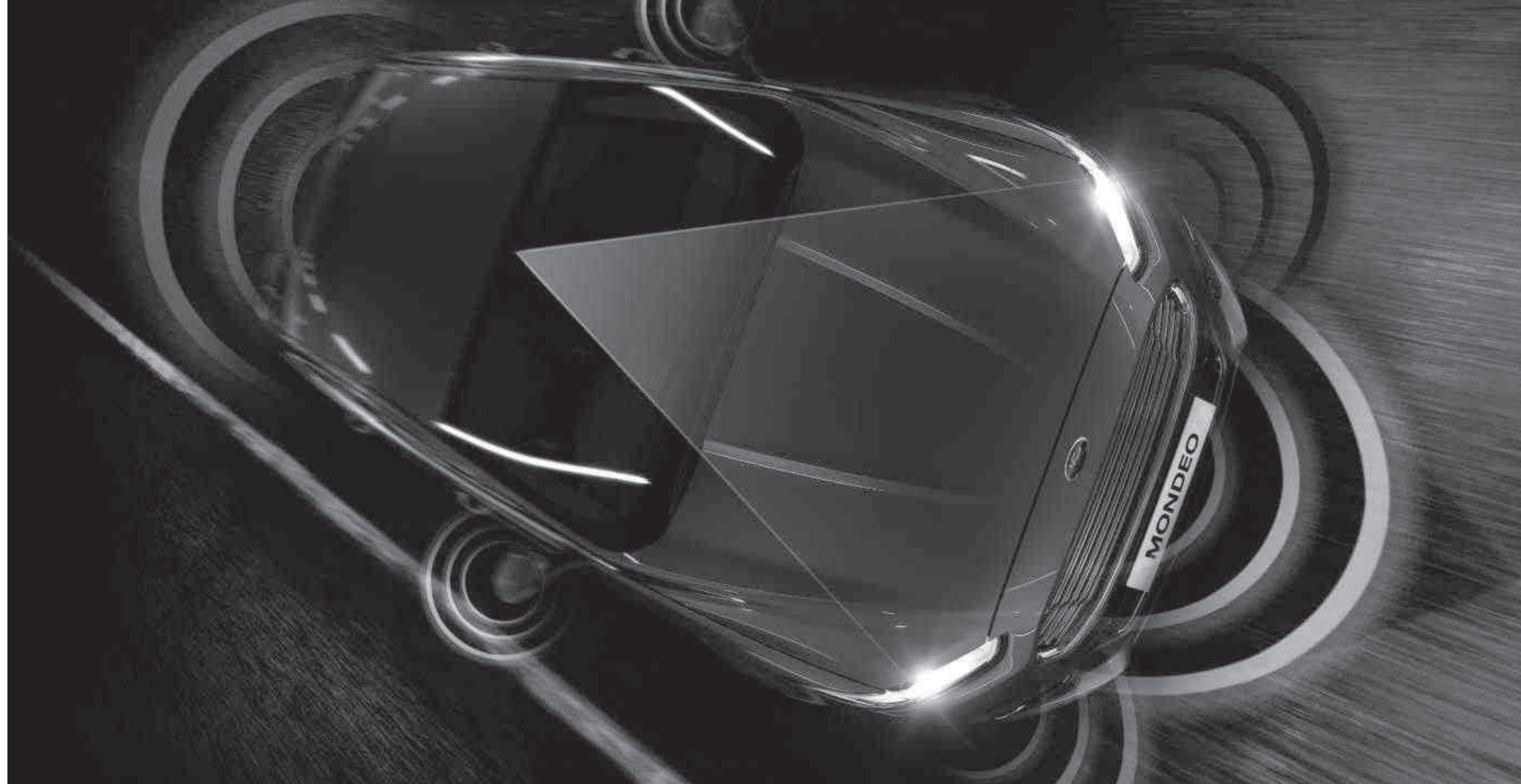

Safety and security equipment

	Style	Zetec	ST-Line	Titanium	Titanium HEV
Safety					
Active City Stop ¹⁾	○	○	○	○	○
Anti-lock braking system with electronic brake-force (ABS) ¹⁾	●	●	●	●	●
Electronic Stability Control ¹⁾ with Traction Control ¹⁾ and Emergency Brake Assist (EBA) ¹⁾	●	●	●	●	●
Blind Spot Information system ²⁾	–	○	○	○	○
Hill Start Assist (HSA) ²⁾	●	●	●	●	●
Intelligent Protection System (IPS) ¹⁾	●	●	●	●	●
Lane Keeping Alert ²⁾ (including Lane Keeping Aid ²⁾ , Auto High Beam ¹⁾ , Driver Alert ²⁾ and Traffic Sign Recognition ²⁾)	–	○	○	●	●
Traffic Sign Recognition ²⁾	–	○	○	●	●
Tyre Pressure Monitoring ¹⁾	●	●	●	●	●
Airbags – Driver's and front passenger's ^{*)}	●	●	●	●	●
Airbags – Driver's and front passenger side airbag ¹⁾	●	●	●	●	●
Airbags – Driver's and passenger's 1st and 2nd row side curtain ¹⁾	●	●	●	●	●
Airbags – Driver's knee bolster ¹⁾	●	●	●	●	●
Airbags – Inflatable Rear Seatbelts (outer seats) ¹⁾	○	○	○	○	○
Airbags – Passenger airbag deactivation switch ¹⁾	●	●	●	●	●
Security					
Ford KeyFree System with Ford Power Starter Button (Keyless starter button is standard on Titanium & Titanium HEV series. Ford KeyFree System is also available as part of the optional Titanium X Pack on Titanium & Titanium HEV)	–	○	○	○	○
Power rear door and window child locks	●	●	●	●	●
Remote, power central double locking	●	●	●	●	●
Thatcham Category 1 alarm with volume sensing, perimeter alarm battery backed	●	●	●	●	●

● = Standard, ○ = Optional, at extra cost, □ = Part of an option pack, at extra cost. ¹⁾Safety feature, ²⁾Driver assistance feature. *Please note Inflatable Rear Seatbelts are not compatible with some child seats. Please contact your Ford Dealership for more information.

***Note: A child seat should never be placed in the front Passenger seat when the Ford vehicle is equipped with an operational front Passenger's airbag. The safest place for children is properly restrained on the rear seat.**

Distributes crash forces over a wider area

Inflatable rear seat belt

In the case of a frontal or side crash, the inflatable rear safety belt's tubular bag breaks through the belt fabric as it fills with gas, expanding sideways across the passenger's body. It is designed to hold the passenger in the appropriate seating position more effectively. Crash forces are distributed over an area five times as wide as a conventional seat belt to help to reduce the risk of injury. (Optional)

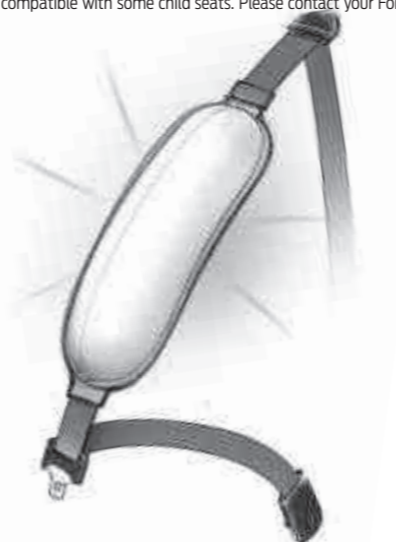

Insurance Groups

	Style	Zetec	ST-Line	Titanium	Titanium HEV
4-door Saloon					
2.0 HYBRID Electric Vehicle (187 PS), 6-speed auto	–	–	–	–	21E
5-door Hatchback					
1.0 Ford EcoBoost (125 PS) (with Auto-Start-Stop), 6-speed manual	–	17E	–	–	–
1.5 Ford EcoBoost (160 PS) (with Auto-Start-Stop), 6-speed manual	–	23E	–	23E	–
1.5 Ford EcoBoost (160 PS) (with Auto-Start-Stop), 6-speed auto	–	23E	–	23E	–
2.0 Ford EcoBoost (240 PS) (with Auto-Start-Stop), 6-speed auto	–	–	–	29E	–
1.5 Duratorq TDCi (120 PS) (with Auto-Start-Stop), 6-speed manual ECOnetic	17E	17E	–	17E	–
2.0 Duratorq TDCi (150 PS) (with Auto-Start-Stop), 6-speed manual	–	23E	23E	23E	–
2.0 Duratorq TDCi (150 PS) (with Auto-Start-Stop), 6-speed manual AWD	–	23E	–	23E	–
2.0 Duratorq TDCi (150 PS) (with Auto-Start-Stop), 6-speed manual ECOnetic	23E	23E	–	23E	–
2.0 Duratorq TDCi (150 PS) (with Auto-Start-Stop), PowerShift 6-speed auto	–	23E	–	23E	–
2.0 Duratorq TDCi (180 PS) (with Auto-Start-Stop), 6-speed manual	–	–	27E	27E	–
2.0 Duratorq TDCi (180 PS) (with Auto-Start-Stop), PowerShift 6-speed auto	–	–	27E	27E	–
2.0 Duratorq TDCi (180 PS) (with Auto-Start-Stop), PowerShift 6-speed auto AWD	–	–	26E	26E	–
2.0 Duratorq TDCi (210 PS) (with Auto-Start-Stop), PowerShift 6-speed auto	–	–	–	30E	–
5-door Estate					
1.0 Ford EcoBoost (125 PS) (with Auto-Start-Stop), 6-speed manual	–	17E	–	–	–
1.5 Ford EcoBoost (160 PS) (with Auto-Start-Stop), 6-speed manual	–	23E	–	23E	–
1.5 Ford EcoBoost (160 PS) (with Auto-Start-Stop), 6-speed auto	–	23E	–	23E	–
2.0 Ford EcoBoost (240 PS) (with Auto-Start-Stop), 6-speed auto	–	–	–	29E	–
1.5 Duratorq TDCi (120 PS) (with Auto-Start-Stop), 6-speed manual ECOnetic	17E	17E	–	17E	–
2.0 Duratorq TDCi (150 PS) (with Auto-Start-Stop), 6-speed manual	–	23E	23E	23E	–
2.0 Duratorq TDCi (150 PS) (with Auto-Start-Stop), 6-speed manual AWD	–	23E	–	23E	–
2.0 Duratorq TDCi (150 PS) (with Auto-Start-Stop), 6-speed manual ECOnetic	23E	23E	–	23E	–
2.0 Duratorq TDCi (150 PS) (with Auto-Start-Stop), PowerShift 6-speed auto	–	23E	–	23E	–
2.0 Duratorq TDCi (180 PS) (with Auto-Start-Stop), 6-speed manual	–	–	27E	27E	–
2.0 Duratorq TDCi (180 PS) (with Auto-Start-Stop), PowerShift 6-speed auto	–	–	27E	27E	–
2.0 Duratorq TDCi (180 PS) (with Auto-Start-Stop), PowerShift 6-speed auto AWD	–	–	27E	26E	–
2.0 Duratorq TDCi (210 PS) (with Auto-Start-Stop), PowerShift 6-speed auto	–	–	–	30E	–

E = Exceeds security requirement for model concerned and group rating has been reduced. Insurance ratings are issued by the Association of British Insurers and are shown above on the 1-50 rating scale.

Fuel, performance and emissions

The fuel economy figures quoted in the table below are achieved by following strict EU governed test procedures and are specifically designed to enable customers to compare vehicles from all manufacturers on a like-for-like basis. Fuel consumption is directly affected by the length of the journey; number of passengers and amount of luggage carried; individual driving style; road and traffic conditions; weather conditions; vehicle age, mileage, condition and standard of maintenance; use of vehicle features such as air conditioning; and any modifications to the vehicle such as the addition of a roof rack. Your fuel economy will vary based on these and other factors and, for these reasons, many drivers may not achieve the EU fuel economy figures (below) in day-to-day driving, although the vehicle is technically capable of doing so.

	Euro Stage	Transmission	Maximum Power PS (kW)	Torque Nm	CO ₂ emissions (g/km) ⁹⁰	Fuel consumption in MPG (L/100 km) ⁹⁰			Performance ^a		
						Urban	Extra Urban	Combined	Max. speed (mph)	0-62 mph (secs)	31-62 mph* (secs)
5-door Hatchback											
1.0 Ford EcoBoost (125 PS) (with Auto-Start-Stop)	Stage VI	M6	125 (92)	170	119	44.8 (6.3)	64.2 (4.4)	55.4 (5.1)	124	12.0	13.1
1.5 Ford EcoBoost (160 PS) (with Auto-Start-Stop)	Stage VI	M6	160 (118)	240	134	36.2 (7.8)	61.4 (4.6)	48.7 (5.8)	138	9.2	8.2
1.5 Ford EcoBoost (160 PS) (with Auto-Start-Stop)	Stage VI	A6	160 (118)	240	146	32.5 (8.7)	57.7 (4.9)	44.8 (6.3)	133	9.1	n/a
2.0 Ford EcoBoost (240 PS) (with Auto-Start-Stop)	Stage VI	A6	240 (176)	340	169	27.7 (10.2)	50.4 (5.6)	38.7 (7.3)	149	7.9	n/a
1.5 Duratorq TDCi (120 PS) (with Auto-Start-Stop) ECOnetic	Stage VI + DPF	M6	120 (88)	270	94	68.9 (4.1)	85.6 (3.3)	78.5 (3.6)	119	12.1	13.6
2.0 Duratorq TDCi (150 PS) (with Auto-Start-Stop)	Stage VI + DPF	M6	150 (110)	370	109	58.9 (4.8)	74.3 (3.8)	67.3 (4.2)	134	9.3	9.6
2.0 Duratorq TDCi (150 PS) (with Auto-Start-Stop)	Stage VI + DPF	M6 AWD	150 (110)	370	124	51.4 (5.5)	64.2 (4.4)	58.9 (4.8)	134	10.3	10.6
2.0 Duratorq TDCi (150 PS) (with Auto-Start-Stop) ECOnetic	Stage VI + DPF	M6	150 (110)	350	107	61.4 (4.6)	76.4 (3.7)	68.9 (4.1)	134	9.4	9.9
2.0 Duratorq TDCi (150 PS) (with Auto-Start-Stop)	Stage VI + DPF	MPS6 (PowerShift)	150 (110)	350	120	53.3 (5.3)	67.3 (4.4)	58.9 (4.6)	132	9.9	n/a
5-door Estate											
1.0 Ford EcoBoost (125 PS) (with Auto-Start-Stop)	Stage VI	M6	125 (92)	170	120	45.6 (6.2)	61.4 (4.6)	54.3 (5.2)	121	12.1	13.3
1.5 Ford EcoBoost (160 PS) (with Auto-Start-Stop)	Stage VI	M6	160 (118)	240	137	35.8 (7.9)	60.1 (4.7)	47.9 (5.9)	135	9.3	8.4
1.5 Ford EcoBoost (160 PS) (with Auto-Start-Stop)	Stage VI	A6	160 (118)	240	152	32.1 (8.8)	54.3 (5.2)	43.5 (6.5)	130	9.2	n/a
2.0 Ford EcoBoost (240 PS) (with Auto-Start-Stop)	Stage VI	A6	240 (176)	340	174	27.4 (10.3)	48.7 (5.8)	37.7 (7.5)	146	8.0	n/a
1.5 Duratorq TDCi (120 PS) (with Auto-Start-Stop) ECOnetic	Stage VI + DPF	M6	120 (88)	270	99	65.7 (4.3)	80.7 (3.5)	74.3 (3.8)	116	11.9	12.2
2.0 Duratorq TDCi (150 PS) (with Auto-Start-Stop)	Stage VI + DPF	M6	150 (110)	370	112	57.7 (4.9)	72.4 (3.9)	65.7 (4.3)	130	9.4	9.8
2.0 Duratorq TDCi (150 PS) (with Auto-Start-Stop)	Stage VI + DPF	M6 AWD	150 (110)	370	127	50.4 (5.6)	62.8 (4.5)	57.7 (4.9)	130	10.5	10.8
2.0 Duratorq TDCi (150 PS) (with Auto-Start-Stop) ECOnetic	Stage VI + DPF	M6	150 (110)	350	109	60.1 (4.7)	74.3 (3.8)	67.3 (4.2)	130	9.5	10.1
2.0 Duratorq TDCi (150 PS) (with Auto-Start-Stop)	Stage VI + DPF	MPS6 (PowerShift)	150 (110)	350	123	52.3 (5.4)	64.2 (4.4)	58.9 (4.8)	129	10.0	n/a

*In 4th gear ⁹⁰Ford test figures ⁹⁰The declared fuel consumptions and CO₂ emissions are measured according to the technical requirements and specifications of European Directive 80/1268/EEC or the European Regulation (EC) 715/2007 amended by (EC) 692/2008 as last amended. Fuel consumption and CO₂ emissions are specified for a vehicle type and not for a single car. The applied standard test procedure enables comparisons between different vehicle types and different manufacturers.

In addition to the fuel efficiency of a car, driving behaviour as well as other non-technical factors are very important in determining a car's fuel consumption and CO₂ emissions. CO₂ is the main greenhouse gas responsible for global warming. A guide on fuel economy and CO₂ emissions which contain data for all new passenger car models is available at any point of sale free of charge or can be downloaded from <http://carfueldata.dft.gov.uk/>

M6 = 6-speed manual, M6 AWD = 6-speed manual with Intelligent All-Wheel drive, A6 = 6-speed automatic, MPS6 = PowerShift automatic

Fuel, performance and emissions (19" wheels)

The fuel economy figures quoted in the table below are achieved by following strict EU governed test procedures and are specifically designed to enable customers to compare vehicles from all manufacturers on a like-for-like basis. Fuel consumption is directly affected by the length of the journey; number of passengers and amount of luggage carried; individual driving style; road and traffic conditions; weather conditions; vehicle age, mileage, condition and standard of maintenance; use of vehicle features such as air conditioning; and any modifications to the vehicle such as the addition of a roof rack. Your fuel economy will vary based on these and other factors and, for these reasons, many drivers may not achieve the EU fuel economy figures (below) in day-to-day driving, although the vehicle is technically capable of doing so.

	Euro Stage	Transmission	Maximum Power PS (kW)	Torque Nm	CO ₂ emissions (g/km) ⁹⁰	Fuel consumption in MPG (L/100 km) ⁹⁰			Performance ^a		
						Urban	Extra Urban	Combined	Max. speed (mph)	0-62 mph (secs)	31-62 mph* (secs)
4-door Saloon with 18" Alloy wheels											
2.0 iVCT HYBRID Electric Vehicle	Stage VI	A6	187 (140)	173	92	97.4 (2.9)	60.1 (5.0)	70.6 (4.0)	116	9.2	n/a
5-door Hatchback with 18" & 19" Alloy wheels											
1.5 Ford EcoBoost (160 PS) (with Auto-Start-Stop) (18" Alloys only)	Stage VI	M6	160 (118)	240	136	35.8 (7.9)	60.1 (4.7)	47.9 (5.9)	138	9.2	8.2
1.5 Ford EcoBoost (160 PS) (with Auto-Start-Stop)	Stage VI	A6	160 (118)	240	148	32.1 (8.8)	56.5 (5.0)	44.1 (6.4)	133	9.1	n/a
2.0 Ford EcoBoost (240 PS) (with Auto-Start-Stop)	Stage VI	A6	240 (176)	340	171	27.4 (10.3)	49.6 (5.7)	38.2 (7.4)	149	7.9	n/a
2.0 Duratorq TDCi (150 PS) (with Auto-Start-Stop)	Stage VI + DPF	M6	150 (110)	370	112	57.7 (4.9)	72.4 (3.9)	56.7 (4.3)	134	9.3	9.6
2.0 Duratorq TDCi (150 PS) (with Auto-Start-Stop)	Stage VI + DPF	M6 AWD	150 (110)	370	127	50.4 (5.6)	62.8 (4.5)	57.7 (4.9)	134	10.3	10.6
2.0 Duratorq TDCi (150 PS) (with Auto-Start-Stop)	Stage VI + DPF	MPS6 (PowerShift)	150 (110)	350	124	52.3 (5.4)	64.2 (4.4)	58.9 (4.8)	132	9.9	n/a
2.0 Duratorq TDCi (180 PS) (with Auto-Start-Stop)	Stage VI + DPF	M6	180 (132)	400	117	55.4 (5.1)	68.9 (4.1)	62.8 (4.5)	140	8.3	8.3
2.0 Duratorq TDCi (180 PS) (with Auto-Start-Stop)	Stage VI + DPF	MPS6 (PowerShift)	180 (132)	400	124	52.3 (5.4)	64.2 (4.4)	58.9 (4.8)	139	8.6	n/a
2.0 Duratorq TDCi (180 PS) (with Auto-Start-Stop)	Stage VI + DPF	MPS6 (PowerShift) AWD	180 (132)	400	138	44.1 (6.4)	58.9 (4.8)	53.3 (5.3)	140	9.3	n/a
2.0 Duratorq TDCi (210 PS) (with Auto-Start-Stop)	Stage VI + DPF	MPS6 (PowerShift)	210 (154)	450	130	48.7 (5.8)	62.8 (4.5)	56.5 (5.0)	145	7.9	n/a
5-door Estate with optional 18" & 19" Alloy wheels											
1.5 Ford EcoBoost (160 PS) (with Auto-Start-Stop) (18" Alloys only)	Stage VI	M6	160 (118)	240	139	35.3 (8.0)	58.9 (4.8)	47.1 (6.0)	135	9.3	8.4
1.5 Ford EcoBoost (160 PS) (with Auto-Start-Stop)	Stage VI	A6	160 (118)	240	154	32.1 (8.8)	53.3 (5.3)	42.8 (6.6)	130	9.2	n/a
2.0 Ford EcoBoost (240 PS) (with Auto-Start-Stop)	Stage VI	A6	240 (176)	340	176	27.2 (10.4)	47.9 (5.9)	37.2 (7.6)	146	8.0	n/a
2.0 Duratorq TDCi (150 PS) (with Auto-Start-Stop)	Stage VI + DPF	M6	150 (110)	350	115	54.4 (5.1)	70.6 (4.0)	64.2 (4.4)	130	9.4	9.8
2.0 Duratorq TDCi (150 PS) (with Auto-Start-Stop)	Stage VI + DPF	M6 AWD	150 (110)	370	131	49.6 (5.7)	61.4 (4.6)	56.5 (5.0)	130	10.5	10.8
2.0 Duratorq TDCi (150 PS) (with Auto-Start-Stop)	Stage VI + DPF	MPS6 (PowerShift)	150 (110)	350	126	51.4 (5.5)	62.8 (4.5)	57.7 (4.9)	129	10	n/a
2.0 Duratorq TDCi (180 PS) (with Auto-Start-Stop)	Stage VI + DPF	M6	180 (132)	400	119	54.3 (5.2)	68.9 (4.1)	62.8 (4.5)	137	8.4	8.4
2.0 Duratorq TDCi (180 PS) (with Auto-Start-Stop)	Stage VI + DPF	MPS6 (PowerShift)	180 (132)	400	126	51.4 (5.5)	62.8 (4.5)	57.7 (4.9)	135	8.7	n/a
2.0 Duratorq TDCi (180 PS) (with Auto-Start-Stop)	Stage VI + DPF	MPS6 (PowerShift) AWD	180 (132)	400	141	45.6 (6.2)	57.7 (4.9)	52.3 (5.4)	137	9.5	n/a
2.0 Duratorq TDCi (210 PS) (with Auto-Start-Stop)	Stage VI + DPF	MPS6 (PowerShift)	210 (154)	450	134	47.1 (6.0)	60.1 (4.7)	54.3 (5.2)	142	8.1	n/a

*In 4th gear ⁹⁰Ford test figures ⁹⁰The declared fuel consumptions and CO₂ emissions are measured according to the technical requirements and specifications of European Directive 80/1268/EEC or the European Regulation (EC) 715/2007 amended by (EC) 692/2008 as last amended. Fuel consumption and CO₂ emissions are specified for a vehicle type and not for a single car. The applied standard test procedure enables comparisons between different vehicle types and different manufacturers.

In addition to the fuel efficiency of a car, driving behaviour as well as other non-technical factors are very important in determining a car's fuel consumption and CO₂ emissions. CO₂ is the main greenhouse gas responsible for global warming. A guide on fuel economy and CO₂ emissions which contain data for all new passenger car models is available at any point of sale free of charge or can be downloaded from <http://carfueldata.dft.gov.uk/>

M6 = 6-speed manual, A6 = 6-speed automatic, MPS6 = PowerShift automatic, M6 AWD = 6-speed manual with Intelligent All-wheel drive, MPS6 AWD = PowerShift automatic with Intelligent All-wheel drive

Weights and loads

	Euro Stage	Kerbweight (kg)*	Gross Vehicle Mass (kg)	Gross Train Mass (kg)	Max. Towable Mass (braked) (kg)*	Max. Towable Mass (unbraked) (kg)
4-door Saloon						
2.0 HYBRID Electric Vehicle (HEV) (187 PS (140 kW)), 6-speed auto	Stage VI	1579	2250	n/a	n/a	n/a
5-door Hatchback						
1.0 Ford EcoBoost (125 PS (92 kW)) (with Auto-Start-Stop), 6-speed manual	Stage VI	1455	2130	3030	900	725
1.5 Ford EcoBoost (160 PS (117 kW)) (with Auto-Start-Stop), 6-speed manual	Stage VI	1484	2160	3410	1250	740
1.5 Ford EcoBoost (160 PS (117 kW)) (with Auto-Start-Stop), 6-speed auto	Stage VI	1505	2190	3640	1450	750
2.0 Ford EcoBoost (240 PS (176 kW)) (with Auto-Start-Stop), 6-speed auto	Stage VI	1564	2230	4030	1800	750
1.5 Duratorq TDCi (120 PS (88 kW)) (with Auto-Start-Stop), 6-speed manual ECONetic	Stage VI + DPF	1494	2170	2570	400	400
2.0 Duratorq TDCi (150 PS (110 kW)) (with Auto-Start-Stop), 6-speed manual	Stage VI + DPF	1578	2260	3910	1650	750
2.0 Duratorq TDCi (150 PS (110 kW)) (with Auto-Start-Stop), 6-speed manual ECONetic	Stage VI + DPF	1578	2260	3860	1600	750
2.0 Duratorq TDCi (150 PS (110 kW)) (with Auto-Start-Stop), 6-speed manual, AWD	Stage VI + DPF	1656	2330	4130	1800	750
2.0 Duratorq TDCi (150 PS (110 kW)) (with Auto-Start-Stop), PowerShift 6-speed auto	Stage VI + DPF	1595	2270	4270	2000	750
2.0 Duratorq TDCi (180 PS (110 kW)) (with Auto-Start-Stop), PowerShift 6-speed auto, AWD	Stage VI + DPF	1683	2330	4330	2000	750
2.0 Duratorq TDCi (180 PS (132 kW)) (with Auto-Start-Stop), 6-speed manual	Stage VI + DPF	1584	2270	4070	1800	750
2.0 Duratorq TDCi (180 PS (132 kW)) (with Auto-Start-Stop), PowerShift 6-speed auto	Stage VI + DPF	1607	2270	4270	2000	750
2.0 Duratorq TDCi (210 PS (154 kW)) (with Auto-Start-Stop), PowerShift 6-speed auto	Stage VI + DPF	1600	2280	4280	2000	750
5-door Estate						
1.0 Ford EcoBoost (125 PS (92 kW)) (with Auto-Start-Stop), 6-speed manual	Stage VI	1476	2230	3130	900	735
1.5 Ford EcoBoost (160 PS (117 kW)) (with Auto-Start-Stop), 6-speed manual	Stage VI	1504	2260	3510	1250	750
1.5 Ford EcoBoost (160 PS (117 kW)) (with Auto-Start-Stop), 6-speed auto	Stage VI	1527	2290	3740	1450	750
2.0 Ford EcoBoost (240 PS (176 kW)) (with Auto-Start-Stop), 6-speed auto	Stage VI	1584	2320	4120	1800	750
1.5 Duratorq TDCi (120 PS (88 kW)) (with Auto-Start-Stop), 6-speed manual ECONetic	Stage VI + DPF	1515	2270	2670	400	400
2.0 Duratorq TDCi (150 PS (110 kW)) (with Auto-Start-Stop), 6-speed manual	Stage VI + DPF	1597	2330	3980	1650	750
2.0 Duratorq TDCi (150 PS (110 kW)) (with Auto-Start-Stop), 6-speed manual ECONetic	Stage VI + DPF	1597	2330	3930	1600	750
2.0 Duratorq TDCi (150 PS (110 kW)) (with Auto-Start-Stop), 6-speed manual, AWD	Stage VI + DPF	1675	2330	4130	1800	750
2.0 Duratorq TDCi (150 PS (110 kW)) (with Auto-Start-Stop), PowerShift 6-speed auto	Stage VI + DPF	1615	2330	4330	2000	750
2.0 Duratorq TDCi (180 PS (110 kW)) (with Auto-Start-Stop), PowerShift 6-speed auto, AWD	Stage VI + DPF	1703	2330	4330	2000	750
2.0 Duratorq TDCi (180 PS (132 kW)) (with Auto-Start-Stop), 6-speed manual	Stage VI + DPF	1602	2330	4130	1800	750
2.0 Duratorq TDCi (180 PS (132 kW)) (with Auto-Start-Stop), PowerShift 6-speed auto	Stage VI + DPF	1615	2330	4330	2000	750
2.0 Duratorq TDCi (210 PS (154 kW)) (with Auto-Start-Stop), PowerShift 6-speed auto	Stage VI + DPF	1619	2330	4330	2000	750

*Represents the lightest kerbweight assuming driver at 75 kg, full fluid levels and 90% fuel levels, subject to manufacturing tolerances and options, etc., fitted.

Towing limits quoted represent the maximum towing ability of the vehicle at its Gross Vehicle Mass to restart on a 12 per cent gradient at sea level.

The performance and economy of all models will be reduced when used for towing. iAWD = Intelligent All-Wheel drive.

Nose weight limit is a maximum of 90 kg on all models. **Gross Train Mass** includes trailer weight.

Colour and trim

Model	Style	Zetec	ST-Line	Titanium	Titanium (with optional Titanium X Pack)
Seat facing trim and colour					
	Cypress in Ebony with white dots	Cypress in Ebony with white dots	Prada in Ebony with Red stitching	Prada in Ebony	Leather in Charcoal Black
Seat bolster trim and colour					
	Omni in Ebony	Omni in Ebony	Omni in Ebony with red stitching	Omni in Ebony	Luxury Leather in Charcoal Black
Door trim insert and colour					
	Omni in Ebony	Omni in Ebony	Omni In Ebony	Omni in Ebony	Soho Vinyl in Charcoal Black
Standard Body Colour					
Blazer Blue	●	●	●	●	●
Premium and Exclusive Body Colours*					
Frozen White (Premium)	○	○	○	○	○
Shadow Black (Premium)	○	○	○	○	○
Magnetic (Premium)	○	○	○	○	○
Moondust Silver (Premium)	○	○	○	○	○
Guard (Exclusive)	○	○	○	○	○
Tectonic Silver (Exclusive)	-	○	○	○	○
Deep Impact Blue (Premium)	○	○	○	○	○
Ruby Red (Exclusive)	-	○	○	○	○
White Platinum (Exclusive)	-	○	○	○	○

● = Standard, ○ = Optional at extra cost, - = Not available.

*Premium and Exclusive Body colours are options at extra cost. Leather seat trim is only available as part of the optional Titanium X Pack which is available at extra cost.

Bodystyle: _____ Series: _____

Engine: _____

Transmission: _____

Colour: _____

Trim: _____

Wheels: _____

Audio: _____

Options: _____

Option Packs: _____

Accessories: _____

Choose

Specify your new car right down to the wheels, audio, options and accessories then visit your Ford dealer.

You can specify your new car online using the Ford Configurator. It lets you instantly see what your car will look like – inside and out – from multiple angles. And a tally of your choices and their prices helps you keep to your budget. Visit www.ford.co.uk/ConfigureyourCar

Finance

When it comes to financing your car, our size and expertise means we're well placed to provide you with a wide range of finance products.

Ford Credit provides a range of finance products for your car whether you are a private or business user.

Ford Lease specialises in contract hire and leasing and provides an alternative range of finance plans which can be tailored to suit your business. Business users only.

For more information about our finance products visit www.ford.co.uk

Drive

When you drive away in your new car, we're with you all the way. Ford has the largest authorised service network in the UK to help you keep your car in the best condition.

And should your new Ford ever require accident repair, a Ford Accident Repair Centre is the best place to get your car back to its pre-accident condition and on the road as quickly as possible.

Contact

Ford Credit Customer Services 0345 712 5490
Ford Lease Customer Services 0344 600 1405

Calls to 0344 and 0345 numbers are charged at the same rate as standard 01 or 02 geographic numbers, even when calling from a mobile.

To configure your Ford online visit www.ford.co.uk/ConfigureyourCar

To look at finance for your Ford visit www.fordcredit.co.uk/BuyingAndProtectingYourFord
Business users visit www.ford.co.uk/FordFleet



Accessories

Load compartment protection

A durable load compartment tray is available (accessory), as well as a reversible load compartment mat that can be extended over the rear seats, together with fold-out bumper protection and a choice of either carpet with Mondeo logo, or a durable rubber surface (option and accessory). Both are ideal for transporting wet or dirty items.

ClimAir® bumper protection

The rear bumper protection plate protects against wear and tear when loading. (Accessory)

Rubber floor mats

All-weather rubberised floor mats are tailor-made and protect against dirt and damp. Securely fixed directly onto the vehicle's floor, the mat is designed not to slip and interfere with the pedals. (Accessory)

Mud flaps

Contoured mud flaps help to keep your Ford Mondeo clean by reducing road spray and stone chips. Available as sets for front and rear. (Option and accessory)

Tow bars

Ford's power-operated retractable tow bar automatically stores itself out of sight below the rear bumper when not in use – retaining the model's sleek looks. (Option and accessory). Also available is a detachable tow bar (option and accessory) and a fixed tow bar (accessory). While towing, the standard Electronic Stability Control (ESC) is designed to counteract trailer sway.

Roof racks

A lockable and sturdy base carrier, or crossbars, will allow you to transport a range of loads safely and easily. Crossbars are only available in combination with roof rails. (Accessory)

Load retention systems

Robust retention systems* keeps items of luggage in the load compartment. A net can be ordered for fitment behind the second row of seats, while a dog guard is available for fitment behind either first or second row. (Option and accessory)

Uebler® rear bike carrier

High-quality tow bar-mounted bike carrier. Features practical tilting mechanism for easy access to the load compartment. (Accessory)



For more accessories for your Mondeo visit www.ford-accessories.co.uk
For a range of Ford branded items – from clothing to lifestyle products and model cars – visit www.fordlifestylecollection.com

+Please see back cover for warranty information.

*Designed to meet European ECE-R17.08/ISO 27955 safety requirements.

Dimensions

	4-door HEV Saloon	5-door Hatchback	5-door Estate
Overall length with/without tow bar (no bodystyling kit) (mm)	n/a	4978/4871	4974/4867
Overall width with/without mirrors (mm)	2121/1852	2121/1852	2121/1852
Overall width with folded back mirrors (mm)	1911	1911	1911
Turning circle – kerb to kerb (m)	11.5	11.5	11.5
Luggage capacity (litres) [†]			
5-seat mode (with Instant Mobility System)	383	550	525
5-seat mode (with mini spare)	n/a	541	500
5-seat mode (with optional full-size spare)	n/a	458	488
2-seat mode (laden to roof) (with Instant Mobility System)	n/a	1446	1630
2-seat mode (laden to roof) (with mini spare)	n/a	1437	1605
2-seat mode (laden to roof) (with full-size spare)	n/a	1356	1585
Fuel tank capacity (litres)			
Petrol	51	62	62
Diesel	n/a	62* (66**)	62* (66**)

[†]Measured in accordance with ISO 3832. Dimensions may vary dependent on the model and equipment fitted. *60 litres for 2.0 Duratorq TDCi engines. **AWD

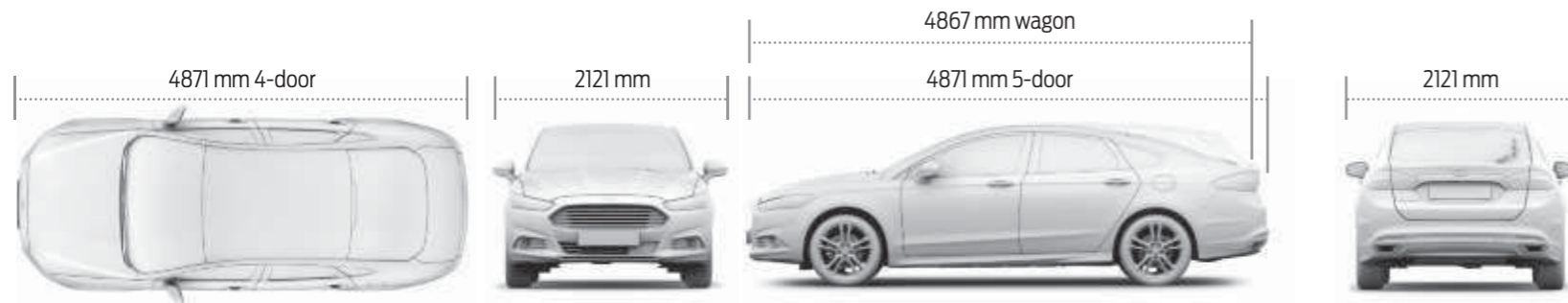

Ford Warranty and Servicing Plans

	All Mondeo Models
3-year/60,000 miles* Ford Warranty	●
1-year unlimited miles* Ford Assistance Roadside Cover (UK & Europe)	●
2 years/2 services 80,000 miles* or 3 years/3 services 100,000 miles* Ford Protect Premium Plan, including scheduled servicing and extended Ford Assistance	○
1-year/unlimited miles* Paint Warranty	●
12-year/unlimited miles* Perforation Warranty	●

● = Standard. ○ = Optional, at extra cost.

*From the date of first registration. Subject to terms and conditions.

Illustrations, descriptions and specifications. This catalogue was correct at the time of going to print. However, Ford policy is one of continuous product development. The right is reserved to change specifications, colours and prices of the models and items illustrated and described in this publication at any time. For the latest details always consult your Ford Dealer. **Optional equipment.** Throughout this publication, wherever a feature is described as being an 'Option' or 'Option Fitment/Pack' etc, you should assume that it will be at extra cost to the base vehicle, unless specifically stated to the contrary. All models and colour combinations are subject to availability. **Note.** Some images portrayed are of a pre-production model and/or are computer generated, therefore, the design/features on the final version of the vehicle may differ in various respects. In addition, some of the features shown on the vehicles may be optional. **Note.** This brochure contains both original Ford accessories as well as a range of products from our suppliers. **★**The identified accessories are carefully selected third party supplier branded accessories which do not come with a Ford warranty but are covered by the third party supplier's own warranty, the details of which can be obtained from your Ford Dealer. **Note.** The Bluetooth® word mark and logos are owned by the Bluetooth SIG, Inc. and any use of such marks by Ford Motor Company is under licence. The iPod word mark and logos are the property of Apple Inc. Other trademarks and trade names are those of their respective owners. **Note.** Some driver assistance features and safety features described in this brochure are designed to function using sensors, whose performance may be affected under certain weather or environmental conditions.

The Government fuel figures do not express or imply any guarantee of the fuel consumption of any particular vehicle. The vehicles themselves have not been tested and there are inevitably differences between individual vehicles of the same model. In addition, a vehicle may incorporate particular modifications. Furthermore, the driver's style and road and traffic conditions, as well as the extent to which the vehicle has been driven and the standard of maintenance, will affect its fuel consumption. **Insurance groups** are only as recommended by the Association of British Insurers. You should always consult your insurance adviser for confirmation.

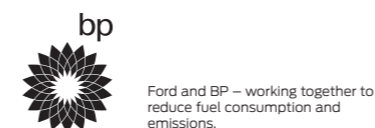

Ford One Call

In the unlikely event that your Ford Dealer can't help you or if you need to speak to us directly, call 0203 564 4444

Ford Rental – local service nationwide

Car and Van rental from our latest model range. Contact your local Ford Dealer for more information

Ford Motability

Call our Ford Motability team on 0345 6040019

Finance

Ford Credit Customer Services 0345 712 5490
Ford Lease Customer Services 0344 600 1405
Calls to 0344 and 0345 numbers are charged at the same rate as a standard 01 or 02 geographic number, even when calling from a mobile.

Published by Ford Motor Company Limited,
Brentwood, Essex, England.
Registered in England No. 235446.
FA 1603/3
BJN 204899. FoE H66E.
PN 674501/0517/GBR en
November 2016.
© Ford Motor Company Limited.



www.ford.co.uk



Go Further