



Volkswagen

The Scirocco



THINK FAST.

If you're the kind of person who thrives on excitement and challenge, who keeps moving forwards and never looks back, who likes things to happen quickly without hanging around, the Scirocco is most definitely the car for you. More exciting, more dynamic and more refined than ever before, this is a coupé that's just waiting to be driven. So, what are you waiting for?



IMPRESS YOURSELF, AS WELL AS OTHERS.

Sleeker, sportier and more dynamic than ever before, the Scirocco is all about the driving experience. The sculpted headlights, black front grille and front air intake with eye-catching honeycomb design, and body-coloured bumpers with aerodynamic fins all create a classic Volkswagen look. This is echoed by the recessed roundel on the bonnet, signifying Volkswagen's legendary heritage. Combined with the latest generation petrol and diesel engines delivering greater performance than ever before, it all adds up to an impressive package. Tempted?



IF YOU DON'T JUST WANT TO BE PUNCTUAL, YOU WANT TO BE THERE FIRST.

The rear of the Scirocco is every bit as impressive as the front. The distinctive roof spoiler and dynamic lines create real presence, while the rear bumper with black diffuser and chrome exhaust tailpipes takes it closer to the road. The rear tail lights and rear number plate lights incorporating LED technology provide a clearer, brighter light and give an athletic look even at night, while the Volkswagen roundel doubles up as a tailgate release.



WHEN GETTING IN IS MORE APPEALING THAN GETTING OUT.

The dashboard and controls of the Scirocco are a tribute to its sporty heritage. The sporty dashboard features a redesigned instrument panel and recessed dials, with brushed aluminium instrument surrounds and decorative inserts in the dash, centre console and door panels. Stylish front sports seats are finished in contemporary 'Scirocco' or 'GT' cloth, or sumptuous 'Vienna' leather upholstery¹, depending on which trim level you opt for. The leather trimmed three-spoke multifunction steering wheel with aluminium inserts, allows you to control the multifunction computer, in-car infotainment system and mobile phone functions without taking your hands off the wheel. Matching leather trimmed gear knob and handbrake grip and white instrument lighting enhance the sporty look, creating an interior that's simply irresistible. Why would you ever want to get out?



Latest generation petrol and diesel engines are equipped with 'BlueMotion Technology' as standard², incorporating a host of measures including the brake energy recuperation system, which recovers part of the energy usually lost during braking, and the Start/Stop system which can save fuel by switching the engine off when the Scirocco comes to a standstill.

¹ Some parts of leather interior will contain artificial leather.
² 'BlueMotion Technology' is not available with 2.0 litre TSI 280 PS engines.



'Long Beach' 7J x 17" alloy wheels are an eye-catching addition to the exterior of the Scirocco. Model shown features optional non-metallic signature paint.



The distinctive rear light clusters blend perfectly with the lines of the Scirocco, complementing its striking design. Its sporty profile is further accentuated by the horizontal, flat surface of the lights, with their dynamic contours. Hi-tech petrol engines feature innovative TSI technology, which utilises a combination of downsizing, direct injection and turbocharging to produce impressive torque and power output. Model shown features optional non-metallic signature paint.



The manual air conditioning system produces a consistent temperature throughout your journey which you can tailor for your comfort. It's extremely user-friendly, achieving your required cabin temperature quickly and efficiently.



The stylish sports instrument dials above the centre console pays homage to the original 1974 model, with gauges for turbo boost pressure, oil temperature as well as a stopwatch to measure journey times.

THE SCIROCCO GT. SIMPLY IRRESISTIBLE.

The Scirocco GT, impressive both inside and out. Sporty 18 inch 'Interlagos' alloy wheels set the scene, with rear tinted glass from the B pillar backwards approximately 65% tinted, front fog lights and front and rear parking sensors completing the exterior look. Inside, driver's and front passenger's sports seats are finished in contemporary 'GT' cloth with Alcantara side bolsters, and the sporty dashboard features 'Chequered Flag' decorative inserts in the dash and centre console, complemented by aluminium inserts in the stylish leather trimmed three-spoke multifunction steering wheel, gear knob and handbrake grip. For added assistance, the multifunction computer performs a number of functions such as displaying the next direction of the Discover Navigation touch-screen navigation/radio system's route with an arrow, helping you keep your eyes focused on the road ahead. You can also control functions of telephones connected via Bluetooth* such as phone book navigation, making and receiving calls and control audio playback. And with 2Zone electronic air conditioning allowing the driver and front seat passenger to regulate their individually preferred temperature, how could you resist?

* Devices must be Bluetooth HFP (Hands Free Profile) compatible, please contact your authorised Volkswagen retailer for specific device compatibility.



The Discover Navigation touch-screen navigation/radio system with Car-Net 'Guide and Inform'¹ includes a 6.5 inch colour touch-screen for navigation, single CD player and radio functions, preloaded European navigation data, 2D/3D map view, three calculated routes (Fast, Short, Eco), dynamic navigation based on TMC+, branded points of interest and Speed Limit Display². Car-Net 'Guide and Inform' functionality allows online access for a period of three years, to a range of useful information such as traffic, fuel pricing, parking space availability, weather and news feeds. The system also includes online navigation software updates, enabling you to download the latest map data, please contact your authorised Volkswagen retailer for full details. Standard on GT models and above, and optional on Scirocco models.



'Interlagos' 8J x 18" alloy wheels with 235/40 R18 self-sealing tyres provide a sporty and dynamic addition to the exterior.

¹ Car-Net 'Guide and Inform' services are accessed via a compatible mobile device. Please see www.volkswagen.co.uk for more information. The use of 'Guide and Inform' services entails exchanging large volumes of data. As such, we strongly recommend that you sign-up for a flat rate data plan with your mobile network provider. After the initial 3-year Car-Net contract, an annual subscription is chargeable for the continuation of Car-Net 'Guide and Inform' services.
² Speed Limit Display only reflects national speed limits and does not show temporary speed limit restrictions, or where permanent changes to speed limits are made in-between map updates.

R-Line

THE SCIROCCO R-LINE. DESIGNED TO BE NOTICED.

Sporty, fun and refined, the Scirocco R-Line has its own unique styling inside and out, providing a level of specification that is fitting for a car of this stature, adding to the excitement of driving this eye-catching car.

Thanks to the **'R-Line' exterior styling pack**, it's easy to recognise this distinctive model, with its specially designed front and rear bumpers, side skirts and black painted radiator grille, which also displays the unique 'R-Line' badging. Dynamic 19 inch 'Talladega' alloy wheels and front fog lights add the finishing touch, creating a look that's sleek, stylish and distinctively R-Line.



The sumptuous interior features a **leather trimmed three-spoke multifunction steering wheel**, gear knob and handbrake grip with aluminium inserts and 'R-Line' logo. This is complemented by aluminium-look pedals, 'Carbon-look' decorative inserts in the dash and centre console and unique 'R-Line' door sill protectors. The latest generation Discover Navigation system features a 6.5 inch colour touch-screen helping to guide you to your chosen destination, while the multifunction colour display allows you to see important information at a glance.



Front sports seats feature an 'R-Line' logo on the head restraints and are superbly finished in luxurious **Titan Black 'Vienna' leather upholstery***. Heated front seats with three preset temperature settings and electrically adjustable lumbar support on the driver's and front passenger's seats helps to ensure optimum driving comfort even on the longest journeys.

* Some parts of leather interior will contain artificial leather.

Black Edition



THE SCIROCCO GT BLACK EDITION AND R-LINE BLACK EDITION.

Distinctive, exclusive and edgy, the Scirocco Black Edition models certainly stand out from the crowd. The accentuated long roofline, darkened rear windows, 'Black' door mirror housings and alloy wheels finished in black, provide a striking contrast to your chosen exterior colour. A stand-out car that looks every bit as special as it drives.

Available in two models, the Scirocco GT Black Edition and R-Line Black Edition get all the specification of the respective GT or R-Line trim, with the addition of 18 inch 'Lisbon Black' alloy wheels on the GT Black Edition, and 19 inch 'Lugano Black' alloy wheels on the R-Line Black Edition model. Both Black Edition models also feature rear tinted glass from B pillar backwards, approximately 90% tinted, together with door mirror housings and rear roof spoiler, all finished and complementing each other in black.



'Lisbon Black' 8J x 18" alloy wheels with 235/40 R18 self-sealing tyres are exclusive to the Scirocco GT Black Edition.



'Lugano Black' 8J x 19" alloy wheels with 235/35 R19 tyres add a stylish look to the Scirocco R-Line Black Edition.



The exterior styling of both Black Editions are enhanced by the 'Black' door mirrors with integrated indicators which perfectly complement the stunning black alloy wheels and striking black roofline.

GTS

THE SCIROCCO GTS.

The Scirocco GTS is certain to attract the attention of admiring eyes wherever it goes. Its unique looks and on the road prowess aren't just empty promises though, they are backed up with the 2.0 litre TSI 220 PS petrol engine which can accelerate the GTS to 62mph in 6.5 seconds on its way to a top speed of 153mph and 152mph for manual and automatic DSG gearboxes respectively where the law permits. Surely that's a combination you can't refuse? Depending on which colour you choose, its exterior look gives the GTS real individuality. With subtle colour co-ordinated decals, edged with distinctive red stripes complementing the car's exterior paintwork, extending from the bonnet, over the roofline and ending on the rear tailgate. The **Sports styling pack** – 'GTS' design front and rear bumpers, radiator grille and side skirts enhance the real sporty feel, rounded off by the stunning 18 inch 'Hayden' alloy wheels. We haven't forgotten the finishing touches either. 'Red' brake callipers sit poised behind the wheels continuing the theme created by the decal, while the unique 'GTS' badging on the radiator grille and rear tailgate leave you in no doubt this is definitely no ordinary Scirocco.



If the outside of the GTS promises, then the interior certainly delivers. The unique chrome 'GTS' door sill protectors, carpet mats with red border stitching and **sumptuous Titan Black 'Vienna' leather*** heated front sports seats with the 'GTS' logo featuring on the backrests, are real highlights. The leather trimmed multifunction steering wheel with 'GTS' logo boasts contrast red stitching, as does the leather trimmed gear lever gaiter and handbrake grip, so even when you're behind the wheel you know you're driving something special. 'Piano Black' decorative inserts in the steering wheel, dash and centre console add to the interior ambience, and lastly, a touch of heritage is included with the unique 'GTS' golf ball design gear knob. This is definitely a car you'll be noticed in.



The unique chrome 'GTS' door sill protectors identify your Scirocco as something special, whilst also protecting the door sill area from scuffs and scratches.

* Some parts of leather interior will contain artificial leather.

Please note, GTS models can be ordered without decals if preferred.

THE SCIROCCO R. ONCE SEEN, NEVER FORGOTTEN.

Everything about the Scirocco R is streamlined and sleek, from its aerodynamic styling to its unique 'R' lowered sports suspension, while the eye-catching exterior style pack and unique interior hint at the experience to come. If you're looking for a combination of style and dynamic drive, the Scirocco R more than delivers.

The side skirts, uniquely shaped front and rear bumpers and 'Gloss Black' front radiator grille of the 'R' styling pack give the Scirocco R its sporty appearance, enhanced by LED daytime running lights set into the front bumper, chrome-look door mirrors with integrated indicators, and unique 'R' badging. To the rear, the 'Gloss Black' diffuser with chrome exhaust tailpipes left and right continue the theme, accentuating the sports suspension lowered by approximately 10mm. The XDS electronic differential lock improves traction and helps keep the 19 inch 'Cadiz' alloy wheels firmly on the road, while the 'Black' brake callipers with unique 'R' logo combine for a truly distinctive look.



Inside, Titan Black 'Vienna' leather heated front sports seats* with an 'R' logo on the head restraints set the scene, while the black rooflining, 'Gloss Black' decorative inserts in the interior door grab handles and centre console, and leather trimmed three-spoke multifunction steering wheel with 'Gloss Black' inserts and 'R' logo continue the theme. Carpet mats front and rear, and unique 'R' door sill protectors complete the elegant look, giving the interior a real sports identity.



Bi-xenon headlights feature dynamic curve lighting, automatic range adjustment, static cornering function and headlight washers, while the 'Gloss Black' radiator grille proudly displays the unique 'R' badging. Model shown features optional metallic signature paint.

* Some parts of leather interior will contain artificial leather.

DRIVING DYNAMICS & SAFETY.

Impressive, sporty and responsive: the running gear of the Scirocco is designed to deliver a dynamic driving style. Dynamic Chassis Control (DCC)* allows you to decide, at the touch of a button, how firm or comfortable you wish to set the suspension, while advanced engineering helps keeps you on track, especially when cornering.

* Dynamic Chassis Control is standard on R and optional on all other models.

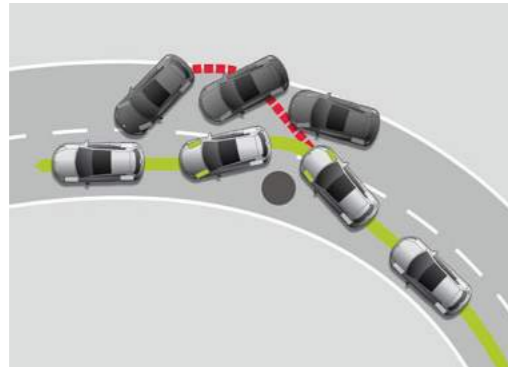
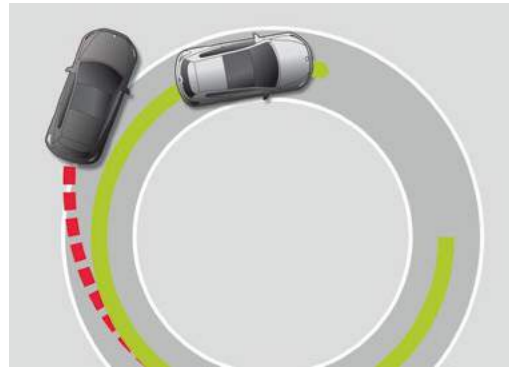

The Scirocco features **XDS**, an extension of the well-known Electronic Differential Lock (EDL) function. This is linked to the Electronic Stability Control (ESC) hydraulics and works by applying pressure to the inner front wheel during cornering to prevent spinning. The one-sided, precise brake pressure helps to maximise traction, reduce understeer and improve responsiveness, thus making cornering more predictable and accurate. Standard on R and optional on all other models except 1.4 litre 125 PS engines.

The **Electronic Stability Control (ESC)** utilises sensors to detect critical situations at an early stage, reacting within milliseconds by controlling the speed of individual wheels, helping to bring the vehicle under control. A careful driving style is essential, however, as even Electronic Stability Control cannot extend beyond the laws of physics. Standard on all models.

Dynamic Chassis Control (DCC) allows you to select Sport, Comfort or Normal settings for your journey with a touch of a button, and adapts the damping control and shock absorption rate to the road conditions and driving style you require within milliseconds. Standard on R and optional on all other models.

The **airbag system** includes driver's and front passenger's airbags with passenger's airbag deactivation switch, front seat side impact airbags and curtain airbag system. If an impact is registered, the airbags are deployed within 30 to 40 milliseconds, the doors are simultaneously unlocked, hazard warning lights and inside lights switched on and the fuel pump deactivated.



A tightly held steering wheel and erratic steering movements are some of the first signs of driver fatigue. If several of these signs appear one after the other, the **Driver Alert system** recommends taking a break via visual and acoustic signals, helping to monitor your driving on longer or monotonous journeys. Optional on all models.



The stylish **sports instrument dials** above the centre console harks back to the original Scirocco from 1974, with gauges for turbo boost pressure, oil temperature and a stopwatch to measure journey times. Standard on all models.

Images shown are for illustration purposes only and may not necessarily reflect UK specification

DESIGNED FOR YOUR COMFORT AND CONVENIENCE.

The Scirocco may be designed for a responsive drive and dynamic handling, but that's not at the expense of **comfort and convenience**, and several key features help to ensure you arrive at your destination cool, calm and collected.



Cruise control, can be set at speeds of over 19mph to maintain a constant speed. Once set to your desired speed, you can focus your attention on the road ahead, creating a more relaxed drive. Optional on all models.



The **keyless entry system** is a convenient addition especially if you have your hands full. As you approach the vehicle, the key automatically unlocks it, enabling you to enter your vehicle and even start the engine using a button in the centre console, without actually using the key itself. Optional on all models.



The high definition **multifunction colour display** is an impressive upgrade to the standard multifunction computer. It presents all the standard journey information, navigational directions, phone book navigation and audio playback control via the multifunction steering wheel on a higher resolution colour screen. Standard on R-Line, R-Line Black Edition, GTS and R models, and optional on Scirocco, GT and GT Black Edition models.



Climate control – 2Zone electronic air conditioning with automatic air recirculation features dual zone temperature control for the driver and front passenger, allowing each to select their individual preferred temperature. A sensor monitors the outside air quality and if necessary automatically activates the air recirculation function. Standard on GT models and above, and optional on Scirocco models.



Front and rear parking sensors assist with parking manoeuvres by emitting audible and visual warnings, alerting the driver to any obstacles in the way: the closer you are to an obstacle the faster the sound frequency. An additional parking display indicates your position on the display of the vehicle's infotainment system. Optional on Scirocco and standard on all other models.



The **rear-view camera** helps you to reverse park, giving you a clear view to the rear of your vehicle via the vehicle's infotainment system display. Thanks to the high resolution detail, even small obstacles such as kerbs can be clearly recognised and avoided. Optional on all models except Scirocco R.

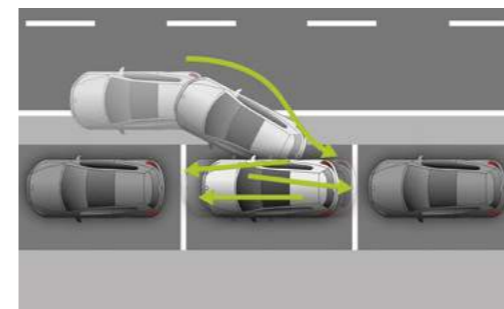

Park Assist helps you parallel and bay park using ultrasonic and audible parking sensors. All the driver has to do is operate the pedals whilst keeping a good look-out and Park Assist will do the rest. Park Assist is optional on GT, GT Black Edition, R-Line, R-Line Black Edition and GTS models. Park Assist including parking sensors, front and rear is optional on Scirocco models. Image shown is for illustration purposes only and may not necessarily reflect UK specification.



Model shown is Scirocco GT with optional 18" 'Lisbon' alloy wheels, panoramic sunroof, 'Vienna' leather upholstery, Bi-xenon headlights and non-metallic signature paint.

The **panoramic sunroof** gives an impressive view of the sky above and adds an extra dimension of light and space, creating a relaxing interior ambience. The roof can be tilted upwards by up to approximately 39mm at the touch of a button, allowing in fresh air, while tinted glass and the fabric roller blind provide additional protection from the sun's rays. Optional on all models.

Please note, Panoramic sunroof is fitted in lieu of storage compartment in the roof console.

MULTIMEDIA.

The optional 'Dynaudio Excite' soundpack is the ideal sound system for your Scirocco, providing improved acoustics over the standard speakers while adding an extra dynamic to the driving experience. For those needing to get places, the Discover Navigation touch-screen navigation/radio system with Car-Net 'Guide and Inform'* will guide you to your chosen destination quickly and easily, while the MDI (Multi Device Interface) via USB connection for connectivity to a compatible device, SD card reader and single CD player allows music playback from MP3, WMA and AAC files.

The Discover Navigation touch-screen navigation/radio system with Car-Net 'Guide and Inform' is standard on GT models and above, and optional on Scirocco models.

* Car-Net 'Guide and Inform' services are accessed via a compatible mobile device. Please see www.volkswagen.co.uk for more information. The use of 'Guide and Inform' services entails exchanging large volumes of data. As such, we strongly recommend that you sign-up for a flat rate data plan with your mobile network provider. After the initial 3-year Car-Net contract, an annual subscription is chargeable for the continuation of Car-Net 'Guide and Inform' services.



The latest generation **Composition Media system** with 6.5 inch colour touch-screen displays DAB digital radio information, title and cover art display and, for compatible Android smartphones, SMS functionality which allows you to read, compose and send SMS messages using the touch-screen display when the vehicle is stationary. Bluetooth telephone and audio connection now allows simultaneous pairing of two compatible mobile devices¹, while the MDI (Multi Device Interface) via USB connection for connectivity to a compatible device, SD card reader and single CD player allows music playback from MP3, WMA and AAC files through eight speakers with 4 x 20 watt output. Standard on Scirocco models.

¹ Devices must be Bluetooth HFP (Hands Free Profile) compatible, please contact your authorised Volkswagen retailer for specific phone compatibility.

The '**Dynaudio Excite**' soundpack has been specially designed for the passenger compartment of the Scirocco, and delivers 400 watts of sound quality through a Digital Signal Processor (DSP), eight channel digital amplifier, eight speakers and subwoofer ensuring the optimum level of listening pleasure. Optional on all models.



The **Discover Navigation touch-screen navigation/radio system with Car-Net 'Guide and Inform'**¹ includes a 6.5 inch colour touch-screen for navigation, single CD player and radio functions, preloaded European navigation data, 2D/3D map view, three calculated routes (Fast, Short, Eco), dynamic navigation based on TMC+, branded points of interest and Speed Limit Display². **Car-Net 'Guide and Inform'** functionality allows online access for a period of three years to a range of useful information such as traffic, fuel pricing, parking space availability, weather and news feeds. The system also includes online navigation software updates, enabling you to download the latest map data, please contact your authorised Volkswagen retailer for full details. Standard on GT models and above, and optional on Scirocco models.

¹ Car-Net 'Guide and Inform' services are accessed via a compatible mobile device. Please see www.volkswagen.co.uk for more information. The use of 'Guide and Inform' services entails exchanging large volumes of data. As such, we strongly recommend that you sign-up for a flat rate data plan with your mobile network provider. After the initial 3-year Car-Net contract, an annual subscription is chargeable for the continuation of Car-Net 'Guide and Inform' services.

² Speed Limit Display only reflects national speed limits and does not show temporary speed limit restrictions, or where permanent changes to speed limits are made in-between map updates.



Car-Net 'App-Connect' combines the functionality of Apple 'CarPlay', Google 'Android Auto' and 'MirrorLink™' allowing the 'mirroring' of a smartphone display and operation of certified apps including audio and voice control (if supported by the app) on the infotainment touch-screen via a USB connection. Please note, there is usage of only certified apps while driving. Optional on all models.

Only operable in conjunction with compatible smartphones including iPhone 5 and 6. Please consult www.volkswagen.co.uk to check smartphone compatibility.

ALLOYS.

- 01 'Long Beach' 7J x 17" alloy wheels with 205/50 R17 tyres* // Standard on Scirocco
- 02 'Interlagos' 8J x 18" alloy wheels with 235/40 R18 self-sealing tyres // Standard on GT and optional on Scirocco
- 03 'Lisbon Black' 8J x 18" alloy wheels with 235/40 R18 self-sealing tyres // Standard on GT Black Edition
- 04 'Talladega' 8J x 19" alloy wheels with 235/35 R19 tyres // Standard on R-Line
- 05 'Lugano Black' 8J x 19" alloy wheels with 235/35 R19 tyres // Standard on R-Line Black Edition and optional on R-Line
- 06 'Hayden' 8J x 18" alloy wheels with 235/40 R18 self-sealing tyres // Standard on GTS
- 07 'Cadiz' 8J x 19" alloy wheels with 235/35 R19 tyres // Standard on R
- 08 'Shanghai' 7J x 17" alloy wheels with 225/45 R17 tyres // Optional on Scirocco
- 09 'Lisbon' 8J x 18" alloy wheels with 235/40 R18 self-sealing tyres // Optional on GT
- 10 'Lugano' 8J x 19" alloy wheels with 235/35 R19 tyres // Optional on R-Line

* 225/45 R17 tyres on 2.0 TSI 180 PS and 2.0 TDI 150 PS models.



04



01



02



03



06



08



09



07



05



10



Think Blue.

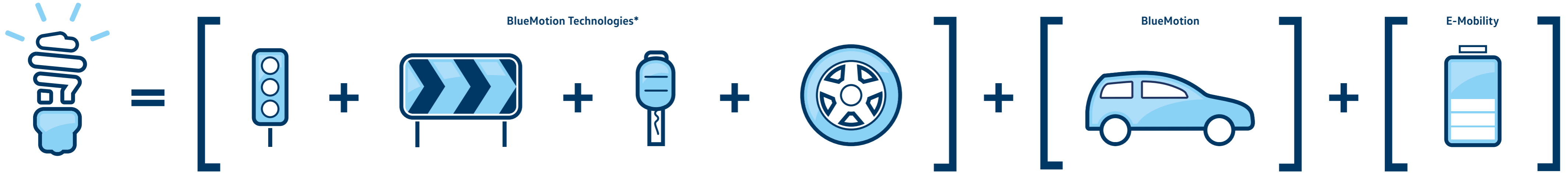

Think Blue.

Start/Stop technology
saves fuel by automatically switching off the engine when the car isn't in motion.

Brake energy recuperation system
makes use of energy that's usually lost when you brake.

Turbocharged engines
deliver more power when you need it and use less fuel when you don't.

Low rolling resistance tyres
reduce the friction between the tyre and the road, meaning it takes less energy – and less fuel – to go further.

Purpose-built BlueMotion cars
include the full range of BlueMotion Technologies as well as an aerodynamically optimised design to reduce wind resistance.

Electric vehicles
comprise both hybrid and fully electric vehicles, offering all the features of their regular counterparts.

*BlueMotion Technologies are available on all Volkswagens and vary between models.

PAINT.



01

SC GT GTBE RL RLBE GTS R



02

SC GT GTBE RL RLBE GTS R



03

SC GT GTBE GTS



04

SC GT GTBE



05

SC GT GTBE R



06

SC GT GTBE



07

SC GT GTBE RL RLBE GTS R



08

SC GT



09

SC GT GTBE RL RLBE R

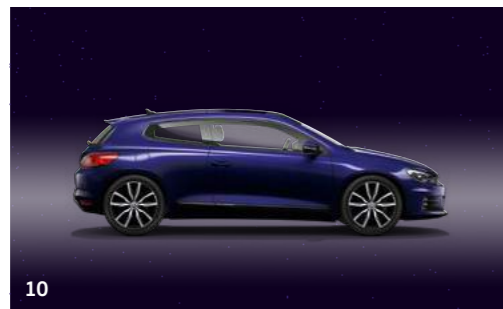

10

SC GT GTBE RL RLBE R



11

SC GT RL GTS R



12

SC GT GTBE RL RLBE GTS R

- 01 Pure White Non-Metallic* 0Q
- 02 Urano Grey Non-Metallic 5K
- 03 Flash Red Non-Metallic Signature* D8
- 04 Reflex Silver Metallic* 8E
- 05 Aztec Gold Metallic* I2
- 06 Dark Oak Brown Metallic* P0
- 07 Indium Grey Metallic* X3
- 08 Night Blue Metallic* Z2
- 09 Rising Blue Metallic Signature* 4C
- 10 Ultra Violet Metallic Signature* Z6
- 11 Deep Black Pearl Effect* 2T
- 12 Oryx White Premium Signature* OR

■ Standard □ Optional

SC | Scirocco GT | GT GTBE | GT Black Edition RL | R-Line RLBE | R-Line Black Edition GTS | GTS R | R

* Optional at extra cost.
Please note: Colour and decal colour ranges are reproduced for illustration purposes only. Actual on-car colours and decal colours may vary from those shown, as print processes do not allow exact reproduction of the paint and decal colours. Models shown are Scirocco GT with optional 18" 'Lisbon' alloy wheels and panoramic sunroof.

GTS STRIPE COMBINATIONS.



Pure White 0Q



Urano Grey 5K



Flash Red D8



Indium Grey X3



Deep Black 2T



Oryx White OR



UPHOLSTERY.

Standard on Scirocco

01 Sports seats in 'Scirocco' cloth – Titan Black QR

Standard on GT, GT Black Edition

02 'GT' cloth seat centre sections and Alcantara side bolsters Titan Black QR

03 'GT' cloth seat centre sections and Alcantara side bolsters Ceramique BS

04 'GT' cloth seat centre sections and Alcantara side bolsters Mocca BT

Standard on R-Line, R-Line Black Edition, GTS

05 Sports seats in 'Vienna' leather* Titan Black QX

Standard on R

06 Sports seats in 'Vienna' leather* Titan Black QX

Optional on Scirocco, GT

07 Sports seats in 'Vienna' leather*† Titan Black BU

08 Sports seats in 'Vienna' leather*† Ceramique BX

09 Sports seats in 'Vienna' leather*† Sioux BZ

Optional on R

10 'Recaro' sports seats in part leather*† Titan Black QX

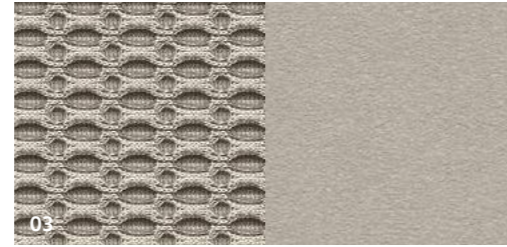
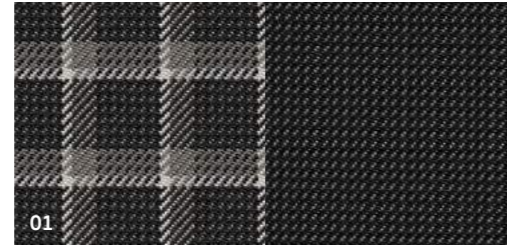

* Some parts of leather interior will contain artificial leather. † Optional at extra cost.
Please note: Swatches reproduced for illustration purposes only. Actual upholstery colours may vary from those shown, as print processes do not allow exact reproduction of the upholstery colours.

COMBINATIONS.

Sports seats in 'Scirocco' cloth

Standard on Scirocco

Titan Black (QR)

Carpet

Dashboard

Pure White
Non-Metallic* 0Q

Urano Grey
Non-Metallic 5K

Flash Red
Non-Metallic
Signature* D8

Reflex Silver
Metallic* 8E

Aztec Gold
Metallic* 12

Dark Oak Brown
Metallic* P0

Indium Grey
Metallic* X3

Night Blue²
Metallic* Z2

Rising Blue
Metallic
Signature* 4C

Ultra Violet
Metallic
Signature* Z6

Deep Black²
Pearl Effect* 2T

Oryx White
Premium
Signature* 0R

Titan Black (QR)	Black	Titan Black/Titan Black	●	●	●	●	●	●	●	●	●	●	●	●	●
------------------	-------	-------------------------	---	---	---	---	---	---	---	---	---	---	---	---	---

'GT' cloth seat centre sections and Alcantara side bolsters

Standard on GT

Titan Black (QR)

Ceramique (BS)

Mocca (BT)

Titan Black (QR)	Black	Titan Black/Titan Black	●	●	●	●	●	●	●	●	●	●	●	●	●
Ceramique (BS)	Black	Titan Black/Titan Black	●	●	●	●	●	●	●	●	●	●	●	●	●
Mocca (BT)	Black	Titan Black/Titan Black	●	●	-	●	●	●	●	●	-	●	●	●	●

'GT' cloth seat centre sections and Alcantara side bolsters

Standard on GT Black Edition

Titan Black (QR)

Ceramique (BS)

Mocca (BT)

Titan Black (QR)	Black	Titan Black/Titan Black	●	●	●	●	●	●	●	●	-	●	●	-	●
Ceramique (BS)	Black	Titan Black/Titan Black	●	●	●	●	●	●	●	●	-	●	●	-	●
Mocca (BT)	Black	Titan Black/Titan Black	●	●	-	●	●	●	●	●	-	-	●	-	●

Sports seats in 'Vienna' leather[†]

Standard on R-Line

Titan Black (QX)

Titan Black (QX)	Black	Titan Black/Titan Black	●	●	-	-	-	-	-	●	-	●	●	●	●
------------------	-------	-------------------------	---	---	---	---	---	---	---	---	---	---	---	---	---

Sports seats in 'Vienna' leather[†]

Standard on R-Line Black Edition

Titan Black (QX)

Titan Black (QX)	Black	Titan Black/Titan Black	●	●	-	-	-	-	-	●	-	●	●	-	●
------------------	-------	-------------------------	---	---	---	---	---	---	---	---	---	---	---	---	---

Sports seats in 'Vienna' leather[†]

Standard on GTS

Titan Black (QX)

Titan Black (QX)	Black	Titan Black/Titan Black	●	●	●	-	-	-	-	●	-	-	-	●	●
------------------	-------	-------------------------	---	---	---	---	---	---	---	---	---	---	---	---	---

Sports seats in 'Vienna' leather[†]

Standard on R

Titan Black (QX)

Titan Black (QX)	Black	Titan Black/Titan Black	●	●	-	-	●	-	●	-	●	●	●	●	●
------------------	-------	-------------------------	---	---	---	---	---	---	---	---	---	---	---	---	---

Sports seats in 'Vienna' leather*[†]

Optional on Scirocco¹ and GT

Titan Black (BU)

Ceramique (BX)

Sioux (BZ)

Titan Black (BU)	Black	Titan Black/Titan Black	○	○	○	○	○	○	○	○	○ ²	○	○	○ ²	○
Ceramique (BX)	Black	Titan Black/Titan Black	○	○	○	○	○	○	○	○	○ ²	○	○	○ ²	○
Sioux (BZ)	Black	Titan Black/Titan Black	○	○	-	○	○	○	○	○	○ ²	-	○	○ ²	○

'Recaro' sports seats³ in part leather*[†]

Optional on R

Titan Black (QX)

Titan Black (QX)	Black	Titan Black/Titan Black	○	○	-	-	○	-	○	-	○	○	○	○	○
------------------	-------	-------------------------	---	---	---	---	---	---	---	---	---	---	---	---	---

● Standard. ○ Optional at extra cost. - Not available.

* Pure White non-metallic, Flash Red non-metallic signature, metallic, pearl effect and premium signature paints, and 'Vienna' leather and 'Recaro' part leather upholstery are optional at extra cost. † Some parts of leather interior will contain artificial leather.
1 Includes black rooflining in lieu of standard grey rooflining. 2 Not available on GT Black Edition models. 3 In lieu of easy entry sliding seats and front seat side impact airbags. Not with driver's seat with electric 12-way adjustment.

There's a Volkswagen for all of us.

Nippy city run around? Luxurious executive saloon? Open-top cruiser? Whatever it is you're looking for, we probably have it. From the iconic Beetle and Golf GTI to the compact up!, there's a Volkswagen for everyone.

If you're thinking you might like to try a different Volkswagen, there are over 20 models in our range, so there's bound to be at least one that catches your eye.

To see these models and configure your ideal Volkswagen, visit: www.volkswagen.co.uk



Sporty

Golf: As exciting to drive as it is to look at. Style, performance and power.

You will also find our sporty gene in the iconic Golf GTD and Golf R.



Spacious family cars

New Sharan: The ultimate in convenience with sliding rear doors, and enough space for the whole family. And their luggage. And the dogs.

If it's space you're after, then you might also like to consider the Tiguan, Golf SV, Golf Estate, new Touran and Passat Estate.



Style

Beetle: The original icon. And still the most unique way to make a fashion statement.

For more fun with the top down, why not consider Beetle Cabriolet or the Golf Cabriolet.



City run around

up!: The ideal city car. Fun, easy to manoeuvre and surprisingly spacious, with that trademark Volkswagen solidity.

If you're looking for something slightly more spacious, then why not consider the up!'s bigger sibling, the Polo. City run around practicality with more versatility and even more space can be found on the iconic Golf.



Executive

Volkswagen CC: Perfectly turned out high-tech, executive luxury. A contemporary, stylish and innovative coupé.

All the luxury you need can also be found in the Jetta, and executive comfort in the Passat and Passat Estate – winner of 'European Car of the Year 2015'.



4x4

Touareg: The SUV just got smarter. True four by four capability off-road, and smooth, luxurious and powerful when on it, with four wheel drive technology, '4MOTION' as standard.

Go everywhere, do anything in our four wheel drive alternatives: Golf Alltrack, Tiguan and Passat and Passat Estate 4MOTION models.

TECHNICAL SPECIFICATION.

	Scirocco, GT, GT Black Edition 1.4 litre TSI 125 PS BlueMotion Technology	Scirocco, GT, GT Black Edition, R-Line, R-Line Black Edition 2.0 litre TSI 180 PS BlueMotion Technology	GTS 2.0 litre TSI 220 PS BlueMotion Technology	R 2.0 litre TSI 280 PS	Scirocco, GT, GT Black Edition, R-Line, R-Line Black Edition 2.0 litre TDI 150 PS BlueMotion Technology	GT, GT Black Edition, R-Line, R-Line Black Edition 2.0 litre TDI 184 PS BlueMotion Technology
Engine						
Engine type	Four cylinder petrol	Four cylinder petrol	Four cylinder petrol	Four cylinder petrol	Four cylinder diesel	Four cylinder diesel
Cubic capacity, ltrs/cc	1.4/1395	2.0/1984	2.0/1984	2.0/1984	2.0/1968	2.0/1968
Max. output, PS ⁽⁰²⁾ /kW	125/92	180/132	220/162	280/206	150/110	184/135
at rpm	5000-6000	4200-6200	4500-6200	6000	3500-4000	3500-4000
Max. torque, lbs.ft/Nm	148/200	207/280	258/350	258/350	251/340	280/380
at rpm	1400-4000	1250-4400	1500-4400	2500-5000	1750-3000	1750-3250
Gearbox	Six speed manual	Six speed manual	Six speed manual	Six speed manual	Six speed manual	Six speed manual
	-	Six speed auto DSG	Six speed auto DSG	Six speed auto DSG	Six speed auto DSG	Six speed auto DSG

Weights, kgs						
Manual gearbox:						
Unladen weight ⁽⁰²⁾	1280	1346	1369	1426	1375	1395
Gross vehicle weight	1680	1750	1750	1770	1780	1800
Payload ⁽⁰²⁾	475	461	456	419	480	480
Axle load limit: Front	950	1020	1020	1040	1050	1070
Rear	780	780	780	780	780	780
Automatic DSG gearbox:						
Unladen weight ⁽⁰²⁾	-	1387	1394	1450	1395	1418
Gross vehicle weight	-	1770	1780	1800	1800	1820
Payload ⁽⁰²⁾	-	458	461	425	480	477
Axle load limit: Front	-	1040	1050	1070	1070	1090
Rear	-	780	780	780	780	780

Load limits, kgs ⁽⁰³⁾						
Max. roof load	75	75	75	75	75	75

	Scirocco, GT, GT Black Edition 1.4 litre TSI 125 PS BlueMotion Technology	Scirocco, GT, GT Black Edition, R-Line, R-Line Black Edition 2.0 litre TSI 180 PS BlueMotion Technology	GTS 2.0 litre TSI 220 PS BlueMotion Technology	R 2.0 litre TSI 280 PS	Scirocco, GT, GT Black Edition, R-Line, R-Line Black Edition 2.0 litre TDI 150 PS BlueMotion Technology	GT, GT Black Edition, R-Line, R-Line Black Edition 2.0 litre TDI 184 PS BlueMotion Technology
Performance						
Top speed, mph (km/h), where the law permits						
Manual gearbox	126 (203)	141 (227)	153 (246)	155 (250)	134 (215)	143 (230)
Automatic DSG gearbox	-	140 (225)	152 (244)	155 (250)	132 (213)	142 (228)
Acceleration, secs 0 - 62mph						
Manual gearbox	9.3	7.4	6.5	5.7	8.6	7.5
Automatic DSG gearbox	-	7.4	6.5	5.5	8.6	7.5
ABL insurance group, 1 - 50	21E, 21E, 22E	30E, 35E, 31E, 35E, 32E	36E	39E	26E, 26E, 26E, 27E, 26E	31E, 32E, 32E, 32E

Environmental information						
Fuel grade, minimum	Unleaded, 95 RON	Unleaded, 95 RON	Unleaded, 95 RON	Unleaded, 95 RON	Diesel ⁽⁰⁴⁾	Diesel ⁽⁰⁴⁾
Fuel tank capacity, galls/ltrs ⁽⁰⁵⁾	12.1/55	12.1/55	12.1/55	12.1/55	12.1/55	12.1/55
Official fuel consumption						
manual gearbox,						
mpg/ltr per 100km ⁽⁰⁶⁾						
Urban	41.5/6.8 ⁽⁰⁶⁾	37.2/7.6 ⁽⁰⁶⁾	37.2/7.6 ⁽⁰⁶⁾	25.4/11.1 ⁽⁰⁶⁾	56.5/5.0 ⁽⁰⁶⁾	49.6/5.7 ⁽⁰⁶⁾
Extra-urban	62.8/4.5 ⁽⁰⁶⁾	53.3/5.3 ⁽⁰⁶⁾	53.3/5.3 ⁽⁰⁶⁾	45.6/6.2 ⁽⁰⁶⁾	74.3/3.8 ⁽⁰⁶⁾	67.3/4.2 ⁽⁰⁶⁾
Combined	52.3/5.4 ⁽⁰⁶⁾	46.3/6.1 ⁽⁰⁶⁾	46.3/6.1 ⁽⁰⁶⁾	35.3/8.0 ⁽⁰⁶⁾	67.3/4.2 ⁽⁰⁶⁾	60.1/4.7 ⁽⁰⁶⁾
Official fuel consumption						
automatic DSG gearbox,						
mpg/ltr per 100km ⁽⁰⁶⁾						
Urban	-	34.9/8.1 ⁽⁰⁶⁾	34.9/8.1 ⁽⁰⁶⁾	26.2/10.8 ⁽⁰⁶⁾	52.3/5.4 ⁽⁰⁶⁾	50.4/5.6 ⁽⁰⁶⁾
Extra-urban	-	53.3/5.3 ⁽⁰⁶⁾	53.3/5.3 ⁽⁰⁶⁾	45.6/6.2 ⁽⁰⁶⁾	68.9/4.1 ⁽⁰⁶⁾	65.7/4.3 ⁽⁰⁶⁾
Combined	-	44.1/6.4 ⁽⁰⁶⁾	44.1/6.4 ⁽⁰⁶⁾	35.8/7.9 ⁽⁰⁶⁾	62.8/4.5 ⁽⁰⁶⁾	58.9/4.8 ⁽⁰⁶⁾
Official CO ₂ emission, g/km						
Manual gearbox ⁽⁰⁶⁾	125 ⁽⁰⁶⁾	142 ⁽⁰⁶⁾	142 ⁽⁰⁶⁾	187 ⁽⁰⁶⁾	109 ⁽⁰⁶⁾	124 ⁽⁰⁶⁾
Automatic DSG gearbox ⁽⁰⁶⁾	-	148 ⁽⁰⁶⁾	148 ⁽⁰⁶⁾	185 ⁽⁰⁶⁾	119 ⁽⁰⁶⁾	125 ⁽⁰⁶⁾
Emission class	EURO 6	EURO 6	EURO 6	EURO 6	EURO 6	EURO 6
Noise, dB						
Manual gearbox	71.0	73.0	75.0	75.0	72.0	73.0
Automatic DSG gearbox	-	74.0	74.0	73.0	74.0	69.0

TECHNOLOGY.

Technical specification notes

- 01 The maximum power output figures are quoted in PS (or Pferdestärke, which is the metric equivalent of horsepower). To convert from metric to imperial horsepower, divide the PS figure by 1.0139.
- 02 Figures are calculated in accordance with manufacturer's criteria. The individual unladen weight depends on the specification of the vehicle, this then reduces the possible payload accordingly. The unladen weight and payload both include the fuel tank 90% full, driver (68kg) and luggage (7kg) in line with EU directive 95/48.
- 03 With increasing altitude the engine performance diminishes. From 1,000m above sea level and for every 1,000m thereafter 10% of the vehicle/trailer weight (trailer weight + gross vehicle weight) must be deducted.
- 04 The use of 100% RME and FAME (bio diesel) is not possible. Forecourt diesel with up to 7% bio diesel content, adhering to standard BS EN 590, can be used in diesel engines. The use of ethanol in forecourt petrol meeting BS EN 228 is allowable.
- 05 The size of the fuel tank is approximate and therefore it may be possible to add a greater amount of fuel than the size of the tank specified, due to the space in the filler neck.
- 06 Fuel consumption and CO₂ figures are obtained under standardised EU test conditions (Directive 93/116/EEC). This allows a direct comparison between different manufacturer models but may not represent the actual fuel consumption achieved in 'real world' driving conditions. More information is available on the Volkswagen website at www.volkswagen.co.uk and at www.dft.gov.uk/vca. The weight of a vehicle will influence the level of CO₂ emissions it produces; as a result, vehicles with higher levels of specification and factory-fitted options may emit higher levels of CO₂. Choosing larger alloy wheels than those fitted as standard may result in increased fuel consumption as well as higher CO₂ emissions and subsequently an increased Vehicle Excise Duty (VED) band. BIK rates paid by company car drivers may also increase. In some instances, the 'On The Road' cost paid for a vehicle may increase as a result of the increased VED rate. CO₂ is the main greenhouse gas responsible for global warming. The specifications contained in this brochure are for information purposes only and are subject to change.

Exterior dimensions	Scirocco, GT, GT Black Edition, R-Line, R-Line Black Edition, GTS	R
Length, mm	4256	4248
Width – including door mirrors, mm	2080	2080
Width – excluding door mirrors, mm	1810	1820
Width – opened doors, mm	4164	4164
Height – with antenna, mm	1406	1398
Height – opened bonnet/floor, mm	1756	1748
Height – opened tailgate/floor, mm	1867	1859
Wheelbase, mm	2578	2578
Turning circle, mm	11000	11000

Interior dimensions		
Effective headroom – front, mm (with sunroof)	953 (950)	953 (950)
Effective headroom – rear, mm (with sunroof)	924 (923)	924 (923)
Elbow width, front, mm	1443	1443
Elbow width, rear, mm	1272	1272

Maximum luggage capacity, litres VDA measuring method using 200 x 100 x 50mm blocks

With rear seat upright	312	312
With rear seat folded	1006	1006

All figures in millimetres.

Figures shown are for standard specification models. The addition of certain factory-fitted options and/or accessories may affect some of the dimensions shown.

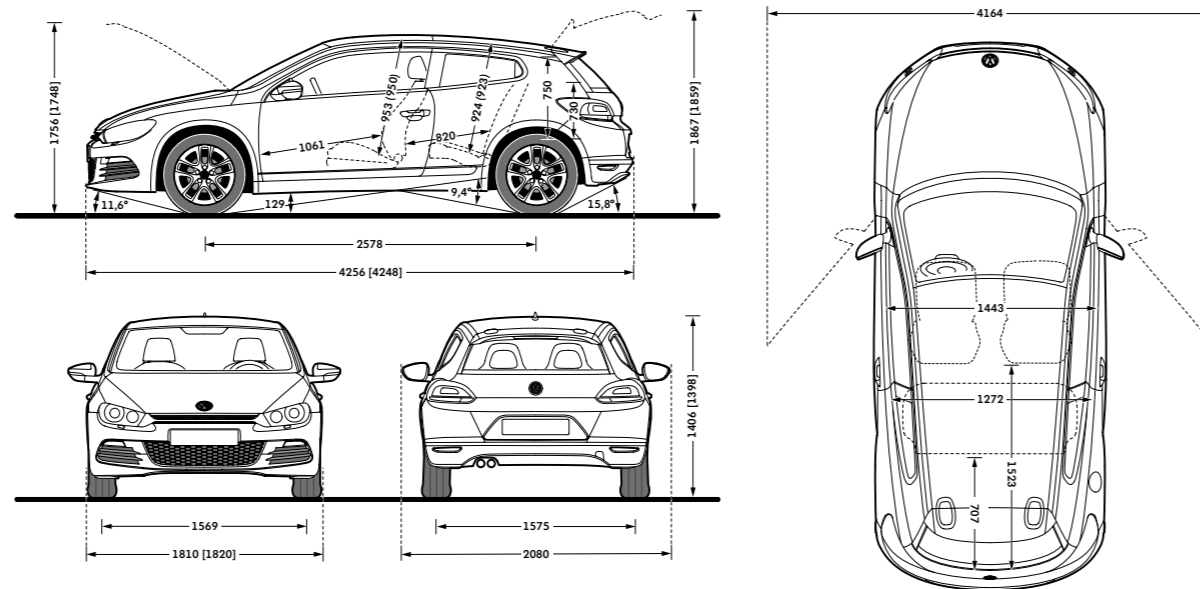

All figures in millimetres. [] Figures in brackets are for R model.

On illustrations, where arrows and figures are shown inside of the vehicle, the measurements are for interior dimensions. Where arrows and figures are shown outside of the vehicle, the measurements are for exterior dimensions.

Engines

Front transverse-installed engine

1.4 litre/125 PS⁽⁰¹⁾ (92 kW) petrol engine: EU6 emissions standard, four cylinder in-line direct injection turbocharged engine with four valves per cylinder. Fitted with a turbocharger. Available with six speed manual transmission.

2.0 litre/180 PS⁽⁰¹⁾ (132 kW) petrol engine: EU6 emissions standard direct injection, four cylinder in-line direct injection twin-charged engine with four valves per cylinder, a supercharger and a turbocharger. Available with six speed manual or a six speed automatic DSG transmission.

2.0 litre/220 PS⁽⁰¹⁾ (162 kW) petrol engine: EU6 emissions standard, four cylinder in-line direct injection turbocharged engine. Fitted with four valves per cylinder and a turbocharger. Available with a six speed manual or a six speed automatic DSG transmission

2.0 litre/280 PS⁽⁰¹⁾ (206 kW) petrol engine: EU6 emissions standard direct injection, four cylinder in-line engine, aluminium cylinder head, four valves per cylinder with roller rocker finger valve drive, electronic direct injection, variable inlet valve timing, programmed ignition with cylinder-selective anti-knock control, four single spark ignition coils, longlife spark plugs, exhaust gas turbocharger, three-way close-coupled pre-catalyst and underbody catalyst, lambda control. Available with six speed manual or a six speed automatic DSG transmission.

2.0 litre/150 PS⁽⁰¹⁾ (110 kW) common rail diesel engine: EU6 emissions standard, four cylinder in-line common rail diesel engine with four valves per cylinder. Fitted with a turbocharger and a DPF (diesel particulate filter). Available with a six speed manual or a six speed automatic DSG transmission.

2.0 litre/184 PS⁽⁰¹⁾ (135 kW) common rail diesel engine: EU6 emissions standard, four cylinder in-line common rail diesel engine with four valves per cylinder. Fitted with a turbocharger and a DPF (diesel particulate filter). Available with a six speed manual or a six speed automatic DSG transmission.

Transmission

- Front wheel drive through asbestos-free single-plate dry clutch. Hydraulic clutch-mechanism. Six speed manual, six speed automatic DSG gearbox with double joint half axles (wet clutch on six speed DSG models)
- Six speed manual: 1.4 litre TSI 125 PS, 2.0 litre TSI 180 PS, 2.0 litre TSI 220 PS, 2.0 litre TSI 280 PS, 2.0 litre TDI 150 PS, 2.0 litre TDI 184 PS
- Six speed automatic DSG: 2.0 litre TSI 180 PS, 2.0 litre TSI 220 PS, 2.0 litre TSI 280 PS, 2.0 litre TDI 150 PS, 2.0 litre TDI 184 PS

Running gear

- Electronic Stability Control (ESC) including Electronic Differential Lock (EDL), Traction Control (ASR) and Countersteer Support
- Front and rear anti-roll bar
- Front suspension through coil springs with telescopic shock absorbers, all elements integrated in chassis legs
- Rear suspension with gas pressure shock absorbers and separate springs
- Wheel control: front through chassis legs and (lower) triangular wishbones (directionally stabilising steering roll radius)
- Wheel control: rear through four-link suspension with independent wheel suspension
- XDS electronic differential lock (R models only)

Steering

- Electro-mechanical steering rack
- Collapsible, height and lengthways adjustable safety steering column

Brakes

- Electronically controlled Anti-lock Braking System (ABS) with Electronic Brake-pressure Distribution (EBD)
- Diagonal twin-circuit brake system with front and rear disc brakes (front ventilated)
- Asbestos-free brake pads
- Hydraulic Brake Assist (HBA)



VOLKSWAGEN SERVICE.

Exclusions and terms and conditions apply to all warranties and plans listed. For pricing and further details of Volkswagen Warranties and Service Plans, please consult your authorised Volkswagen retailer or repairer, or visit www.volkswagen.co.uk

Three-year Warranty

All Volkswagen passenger cars come with a three-year/60,000 miles warranty, which protects your car against the failure of most technical and electrical components due to manufacturing defects. This comprises a two-year manufacturer's warranty with unlimited mileage plus a further one-year/60,000 miles (whichever is soonest) Retailer Warranty¹. Should the mileage exceed 60,000 miles within the first two years, the manufacturer's two-year warranty will still be valid. Full details of the three-year warranty are available from your authorised Volkswagen retailer or repairer.

Body Protection Warranty

The internal body sections and panels of the Scirocco are covered against rusting through from the inside for 12 years. Naturally, the vehicle must be cared for in compliance with the manufacturer's operating instructions. Please consult your authorised Volkswagen retailer or repairer for full warranty details.

Three-year Paintwork Warranty

This latest paintwork warranty, pioneered by Volkswagen, provides you with cover on a new car. Naturally, during the warranty period the car must be cared for in compliance with the manufacturer's operating instructions. Any paintwork defects, as a result of the manufacturing process, will be rectified without charge.

Approved Accessories

A comprehensive range of accessories from alloy wheels to carpet mats is available to complement the factory-fitted option list. Volkswagen approved accessories purchased from and fitted by your authorised Volkswagen retailer at the point of vehicle sale will also benefit from the three-year vehicle warranty.

Extended Warranty

If you order the Volkswagen Extended Warranty as an option when buying your new Scirocco then you get the 100% Volkswagen Warranty and you can continue to enjoy comprehensive Volkswagen protection against many unforeseeable repair costs. Designed to your needs, you can purchase an extra one or two year's warranty up to a maximum of five years or 90,000 miles.

Service Intervals

Volkswagen is pleased to offer you a choice on how your Volkswagen is serviced. The appropriate selection is entirely dependent on how the car is likely to be driven and its general use. To help you identify which type of service would be most suitable, please refer to the following guide.

The Fixed Service is recommended for vehicles that will cover less than 10,000 miles in 12 months and if the vehicle is likely to be used in the following way:

- Predominantly urban driving, short journeys with frequent cold starts.
- Activities regularly producing high engine loading, e.g. frequent hill climbs, driving with vehicle fully loaded and towing.
- Uneconomical driving style using high rpms with heavy acceleration and heavy braking.

The service intervals for the Fixed Service are as follows:

- Oil change service – After 1 year or 10,000 miles (15,000km), whichever is soonest.
- Inspection service² – First after 2 years or 20,000 miles (30,000km), then every one year or 20,000 miles (30,000km), whichever is soonest.

The Flexible Service is recommended for vehicles with daily mileage of more than 25 miles where the vehicle is driven regularly mainly on longer distance journeys. The vehicle is driven mainly at a constant speed with minimum vehicle and engine loading, minimal towing and driven in an economical manner. With the Flexible Service the vehicle can cover anywhere between 10,000³ and a maximum of 20,000³ miles or 24 months (whichever is soonest) between oil changes.

The service intervals for the Flexible Service are as follows:

- Oil change service – According to flexible service interval display (after 2 years at the latest).
- Inspection service² – First after 2 years or 20,000 miles (30,000km), then every one year or 20,000 miles (30,000km), whichever is soonest.

The up! model is only available with the Fixed Service schedule. Please consult your authorised Volkswagen retailer or repairer for advice and full details.

Please note: If you purchase a Volkswagen Fixed Price Service Plan your vehicle will follow the Fixed Service schedule.

Volkswagen Insurance⁴

We want you to start enjoying your new car from day one and thanks to Volkswagen free 5 day insurance, you can. Call free on 0330 303 6930 (lines are open Monday to Friday 8am – 9pm and Saturday 9am – 5pm), provide a few details and a cover note will be sent to your retailer. They will then tax your car and you can drive it away.

Volkswagen Ensurance⁵

Get three years' Volkswagen Ensurance cover for free.

Another great benefit of being a Volkswagen driver. If your Volkswagen was damaged in an accident, wouldn't you want it fixed by a Volkswagen trained technician using only genuine Volkswagen parts? Ensurance is Volkswagen's accident and repair cover which does exactly that. It works alongside your main comprehensive motor insurance policy no matter who you are insured with, to make sure you get the quality repair and service you would want.

If you're involved in an accident or your car is stolen, just one call to us and we'll look after your claim from start to finish ensuring your Volkswagen is restored to the highest standard.

Activate your cover and benefit from:

- A guarantee that your Volkswagen will be repaired by a Volkswagen approved repairer and Volkswagen trained technicians, using only genuine Volkswagen parts and paints.
- A dedicated Claims Manager who will manage your claim from start to finish, liaising with your insurer and the repairer so you don't have to.
- Help to recover any uninsured losses using our Legal Expenses Cover.
- Online claims tracking so you can keep up to date with the status of any claim.

Volkswagen Ensurance is free to all Volkswagen customers for three years and it only takes a minute to get cover. To find out more and to activate your cover, visit volkswagen-ensurance.co.uk

Volkswagen Finance⁶

Volkswagen Finance specialises in providing funding solutions for Volkswagen drivers. Whether your Volkswagen is for private or business use, you can choose from a range of funding options.

- Solutions – a Personal Contract Plan
- Hire purchase
- Lease purchase
- Finance lease
- Contract hire

With all Volkswagen Finance products you can choose a fixed-cost maintenance plan to help you budget for your servicing and maintenance costs. No matter what finance product you choose, your local Volkswagen retailer will be able to provide you with a personalised quote that could meet your budget and vehicle needs.

Fuel consumption and CO₂ Emissions

Fuel consumption and CO₂ figures are obtained under standardised EU test conditions (Directive 93/116/EEC). This allows a direct comparison between different manufacturer models but may not represent the actual fuel consumption achieved in 'real world' driving conditions. More information is available on the Volkswagen website at www.volkswagen.co.uk and at www.dft.gov.uk/vca.

The weight of a vehicle will influence the level of CO₂ emissions it produces; as a result, vehicles with higher levels of specification and factory-fitted options may emit higher levels of CO₂. Choosing larger alloy wheels than those fitted as standard may result in increased fuel consumption as well as higher CO₂ emissions and subsequently an increased Vehicle Excise Duty (VED) band. BIK rates paid by company car drivers may also increase. In some instances, the recommended 'On the road' retail price paid for a vehicle may increase as a result of the increased VED rate. CO₂ is the main greenhouse gas responsible for global warming.

The specifications contained in this brochure are for information purposes only and are subject to change.

Volkswagen Roadside Assistance

Every new car is registered for Volkswagen Roadside Assistance for one year except the Touareg which is registered for three years. This provides vehicle roadside and home recovery in the unlikely event of a breakdown in the UK and Europe (subject to conditions). Volkswagen Roadside Assistance can also be purchased for subsequent years. For full details, please contact your authorised Volkswagen retailer. Exclusions and terms and conditions apply. For pricing and further details of Volkswagen Roadside Assistance, please consult your authorised Volkswagen retailer, or visit www.volkswagen.co.uk

Tax Free Sales

For full details, please contact your authorised Volkswagen retailer.

Please note:

Some illustrations in this brochure do not necessarily reflect UK specifications and may not be available. In particular, controls and some items of equipment are positioned differently for the UK. The specifications contained in this brochure are for information purposes only and are subject to change. If you require any specific feature, you must consult your authorised Volkswagen retailer who is regularly updated with any change in specification. Please check model availability and full specification details with your authorised Volkswagen retailer prior to ordering. Note: we would like to advise you that telephone calls to Volkswagen Customer Care may be monitored and recorded as part of our training and quality assurance processes. All our monitoring and recording processes meet Ofcom regulations.

¹ All warranty work must be completed by an authorised Volkswagen retailer or repairer.

² The inspection service first at 3 years (or 40,000 miles) and then every second year (or 40,000 miles) has additional workscope.

³ The quoted mileage is based on a conversion from kilometres and is therefore unlikely to exceed circa 18,000 miles between oil changes.

⁴ Volkswagen Financial Services is a trading name of Volkswagen Financial Services (UK) Limited ('VWFS UK'). Registered in England and Wales number: 2835230. Registered Office: Brunswick Court, Yeomans Drive, Blakelands, Milton Keynes MK14 5LR. Financial and consumer credit services are provided by VWFS UK. Annual insurance credit is provided by Ageas Retail Limited.

Volkswagen Motor Insurance from VWFS UK is sold and administered by Ageas Retail Limited, registered in England and Wales number: 1324965. Registered Office: Ageas House, Hampshire Corporate Park, Templars Way, Eastleigh, Hampshire SO53 3YA. VWFS UK and Ageas Retail Limited are not part of the same corporate group.

⁵ Ensurance from Volkswagen Financial Services is sold and administered by Lawshield UK Limited, registered in England number: 3360532 (registered office: Lawshield House, 850 Ibis Court, Lakeside Drive, Centre Park, Warrington, Cheshire WA1 1RL) and underwritten by UK General Insurance Limited on behalf of Ageas Insurance Limited, registered in England number: 354568 (registered office: Ageas House, Tollgate, Eastleigh, Hampshire SO53 3YA).

⁶ Finance is available to 18s and over, subject to status. Terms and conditions apply. Volkswagen Finance.

The Scirocco

Volkswagen Information Service. Telephone: 0800 333 666

Internet: www.volkswagen.co.uk

© Volkswagen Group United Kingdom Limited 2016.

Issue: 1 June 2016.



facebook.com/VolkswagenUK



@UKVolkswagen



youtube.com/user/ukvolkswagen