

2010 BMW X3
Sports Activity
Vehicle®



X3 xDrive30i

The Ultimate
Driving Machine®



THE BMW X3.

FOR THE MOST EXCITING ROAD OF ALL: LIFE.

Contents

2010 BMW X3 Sports Activity Vehicle®

03 | 17 Exterior

18 | 25 Interior

Technology

26 | 27 BMW EfficientDynamics

28 | 29 Engine

30 | 31 xDrive | Safety

Equipment

32 | 35 Paints | Upholsteries | Interior trims | Combinations

36 | 37 Selection

38 | 47 Standard | Optional equipment

48 Safety features and technology illustrations

49 | 53 Equipment charts

54 | 55 Technical data

56 | 57 BMW Services

58 BMW Accessories

At BMW, we believe that ideas are everything.

Because we are an independent company, we have the freedom to make sure that great ideas live on to become Ultimate Driving Machines.® And driving enthusiasts notice.

When you exercise your freedom to just get up and go, you need a companion that is both flexible and reliable. A vehicle that simply looks great against any backdrop, be it a winding mountain pass or the baroque façade of an opera house. Whether you are heading into work, or away for the weekend. Sometimes it can be so simple to follow the road less traveled with the BMW X3 xDrive30i. bmwusa.com/x3

NOTE: BMW NA does not supply or have an approved electrical brake controller for the Trailer Hitch (Tow Bar) Kits.

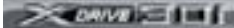
	X3 xDrive30i shown with the following equipment:
BMW X3	Engine: 3.0-liter inline six-cylinder Wheels: Star Spoke (Style 279) light alloy Exterior color: Titanium Silver Metallic Upholstery: Sand Beige Nevada Leather Interior trim: Light Poplar Wood Optional equipment: Cold Weather Package, Premium Package, Privacy glass, Xenon Adaptive Headlights, Park Distance Control
	
For details on Standard and Optional equipment, please refer to Equipment charts pages 49-53.	



X3: Putting the sport in Sports Activity Vehicle.®

BMW EfficientDynamics 
Less emissions. More driving pleasure.

Meet the 2010 BMW X3 xDrive30i. The intersection between great automotive engineering and the great unknown. The X3 is built to take you anywhere and everywhere the only way it can: with power, grace and style. On the open highway or city streets: all roads lead to The Ultimate Driving Machine.®



Now you can blaze your own trails.



From the engine to the interior, from the kidney grille to the taillights, BMW loaded the X3 with thoughtful features and eye-catching design. Some features, like the 3.0-liter powerplant, deliver potent performance; Dynamic Stability Control brake enhancements add to its active safety quotient. And others, like the aggressively styled front exterior, add to its sharp looks. The X3 truly is an all-around stunner.

Exterior 06107

Rugged good looks are just the beginning.



**Experience driving
260 spirited horses
that rarely get thirsty.**



The X3 s 260-horsepower, 3.0-liter engine is all about potent acceleration when you need it merging on highways, changing lanes, quick avoidance maneuvers without sacrificing fuel efficiency. A composite magnesium/aluminum inline six with Valvetronic, it's a modern marvel, smoothly reaching 0-60 in 6.9 seconds.¹ And BMW puts all this power under your control with a choice of 6-speed manual or, at no extra cost, optional 6-speed STEPTRONIC automatic transmission.

¹ Manual transmission; 7.1 seconds, automatic. BMW AG test results. BMW urges you to obey local speed laws and always wear safety belts.

BMW's xDrive all-wheel-drive system gives you more than just asphalt-grabbing traction and superb control. Together with the Dynamic Stability Control (DSC) sensors, xDrive links the X3's safety and handling features with the vehicle's engine management system, giving you the utmost driving confidence in any conditions. Braking, cornering and accelerating maneuvers are optimized for maximum efficiency and dependability. DSC features include Brake Drying, which automatically snugs the brake pads up to the rotors to dry them when moisture is detected; Brake Stand-by, which, when you suddenly remove your foot from the throttle, pre-tenses the brake calipers for quicker action; and Brake Fade Compensation, which keeps your foot's brake pedal action the same, no matter how hot the brakes get. The X3 is also the first BMW SAV® to include Dynamic Traction Control (DTC) as a part of its DSC system, delivering even higher performance in tight turns and on slippery roads.

We call it xDrive. You'll call it a joy to drive.

Exterior 10111





BMW Sports Activity Vehicles® are engineered not only for enhanced traction on slippery roads, but also for BMW-style performance on all surfaces. The feeling you enjoy each time you tackle a curve is due, in no small part, to the X3's near-perfect 50/50 weight distribution, as well as its four-wheel independent suspension, subframe construction, acoustic decoupling and twin-tube gas-pressure shock absorbers. In other words, the X3 is built for a ride that's remarkably quiet, solid, comfortable, agile and responsive in curves.

Built for fun even in dry weather.

The X3.
Great ideas quickly gain momentum.

Exterior 14115



**Originality comes from creative minds.
Not from corporate agendas.**



The BMW X3 was conceived and built by a team of engineers who never have to hear the word *compromise* when it comes to automotive design. The result: a Sports Activity Vehicle® that lets you enjoy the same independence as the company that made it. The X3 is a true BMW original – bold, beautiful and eminently drivable. It's simply the most fun you'll have on four wheels.

With the X3, there's no question who's the center of attention. You are.

Behind the wheel of every X3 sits one very satisfied driver. A wide, high-riding cockpit puts you in command of all you survey. Grip the comfortable steering wheel, warmed for winter with optional heating. Run your fingers over the elegant, uncluttered dashboard and upholstered seats decked out in attractive, fine-grain leather. Delight in the choices of handsome wood trims. Instrument clusters are integrated and optimized, and all frequently used controls are within easy reach. For those who'd rather keep their eyes on the road, the X3 provides an outstanding point of view.

Shown with Sand Beige Nevada Leather upholstery, Light Poplar Wood trim and optional Sport Package.





The look and feel of luxury.

From thoughtful conveniences, such as side-door pockets that are wide enough to hold water bottles, to numerous luxurious touches, the X3 s spacious interior is designed to make you feel welcome. Even the grain of the leather-covered dash is fine and supple. The trim package is available in three stunning, genuine wood grain options. An auxiliary input on the center console comes standard and lets you run your MP3 player through the X3 s SIRIUS Satellite Radio sound system. HD Radio™ receives free, digital broadcasts with CD-quality sound, multicast FM stations, and innovative data services. Inside and out, every inch of the X3 is a showcase of BMW quality.

Shown with Sport Package interior.

For details on the availability of standard and optional features, please refer to the Standard equipment | Optional equipment charts at the back of this brochure.

The image shows the rear passenger compartment of a car. The seats are upholstered in a light beige leather with a quilted pattern. A center console is visible between the seats, and a door panel with a wood-grain trim is on the right. The car is parked on a beach, with the ocean and a pier visible through the windows.

The battle for the front passenger seat is officially over.

Unlike other vehicles in its class, the X3 is one thrill ride with space for everybody. The rear seating area amply accommodates up to three adults, giving your passengers a leg up on legroom. A folding center back-seat console allows two passengers to enjoy a typical front-seat amenity. The comfortable seating design and trim add to the elegance. And with the heated rear seats – a rare luxury – available as part of the X3 s Cold Weather Package, back-seat passengers stay cozy and warm.

For details on the availability of standard and optional features, please refer to the Standard equipment | Optional equipment charts at the back of this brochure.

Plenty of room for all that matters.

A spacious and functional cabin is a hallmark of the X3. From the front-seat cupholders to the 60/40 split-folding rear seats to the bicycle rack accessory that easily stows two bikes, the X3 is designed to let you pack more of your life into your BMW safely and quickly. Roof rails make topside hauling a breeze, while the interior boasts plenty of room for groceries, sports equipment and more. The interior rails, luggage nets and reversible non-slip floor help keep your cargo secure on any trip. Which is good news, since you're going to want to keep on driving the X3 mile after mile to work, on vacation, and whenever the need for fun moves you.

For details on the availability of standard and optional features, please refer to the Standard equipment | Optional equipment charts at the back of this brochure.



This is how much has gone in.

At BMW, we create dynamic vehicles that thrill you with quick acceleration, exemplary handling and unshakable control. We are also busy finding ways to sustain this level of performance while incorporating innovative fuels and technologies to help preserve the environment. This is what we refer to as EfficientDynamics. This goal has led to the visionary CleanEnergy hydrogen-powered engine, which is currently used in the BMW Hydrogen 7 Sedan. BMW Advanced Diesel with BluePerformance, which offers diesel power with quick acceleration, increased fuel efficiency and reduced emissions, was introduced to the U.S. in 2009 in select models. In fact, every BMW on the road today comes standard with technology that boosts performance while simultaneously reducing fuel consumption and CO₂ emissions.

Double-VANOS

VANOS is BMW's valve timing system that can steplessly vary the points in the combustion cycle when valves open and close. Double-VANOS refers to the fact that it operates on both the intake and exhaust camshafts. Electronically controlled in response to engine speed, load and temperature, VANOS reduces emissions, and enhances low- to medium-speed torque, as well as fuel efficiency.

Aerodynamics

The more smoothly that air flows over a vehicle, the more efficiently it can operate. All BMWs are designed for a low coefficient of aerodynamic drag, which translates into quicker acceleration, more stable handling, quieter operation and greater fuel efficiency. A BMW's integrated front spoiler reduces the amount of air flowing underneath the vehicle, minimizing front-end lift. This allows a BMW to hug the road at higher speeds for excellent stability.

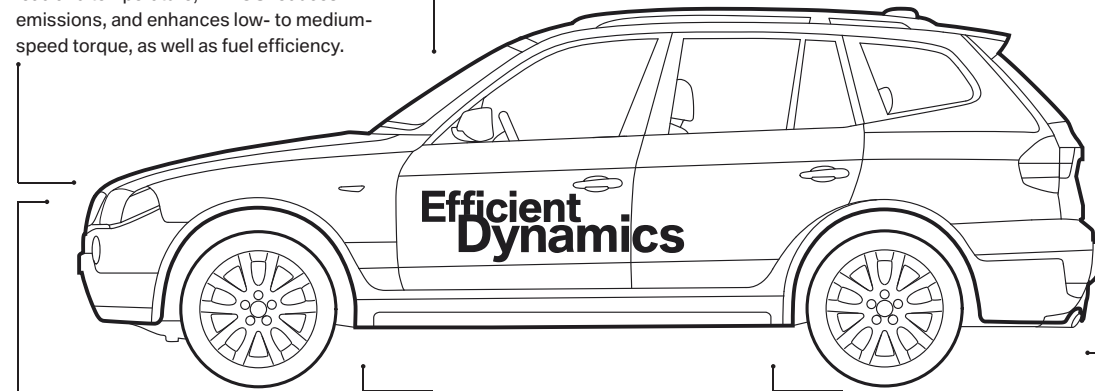

Valvetronic

Instead of using a traditional throttle, Valvetronic technology lets the engine breathe more easily by varying the lift height of the valves to regulate air intake. The result: improved cold starts, smoother running, and a significant drop in fuel consumption. Using revolutionary technology such as this, BMW has improved its overall average fuel economy more than any other manufacturer.

Efficient transmissions

Two highly efficient 6-speed transmissions—a silken manual, and a STEPTRONIC automatic with Adaptive Transmission Control—enhance performance, comfort and fuel efficiency.

Lightweight construction

Our engineers use lightweight aluminum throughout our vehicles—in the front section, for example, or for the suspension. BMW's naturally aspirated inline six-cylinder engine is an aluminum/magnesium composite—the lightest in its class. Taken together, these weight savings lead to lower fuel consumption and better axle load distribution for more agility—especially in curves.

And this is what comes out.

BMW models have low CO₂ emissions today. But that's just for starters. We're carrying on our research in the quest to bring you greater driving pleasure, with fewer emissions and decreased fuel consumption.

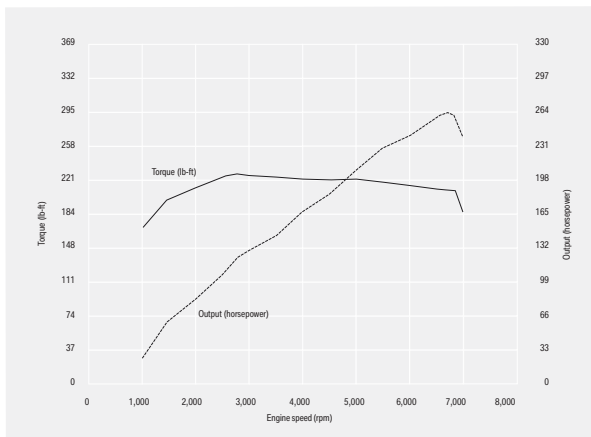

Torque-rich, free-revving and uncommonly smooth: the X3 s inline six eagerly revs to 7000 rpm, producing 260 horsepower at 6600 rpm and 225 lb-ft of torque at just 2750 rpm.

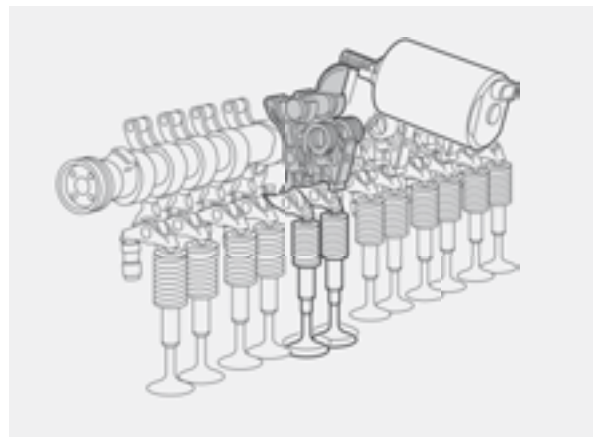

BMW's composite magnesium/aluminum engine with Valvetronic delivers significant weight savings, the benefits of which include great fuel economy.



Six powerful cylinders, six smooth-shifting gears.

What sets BMW engines above the rest? Superior engineering and manufacturing – for example, the timing belt many competitors use to drive the camshafts is commonly made of rubber, and requires costly periodic replacement, usually at 30,000-mile intervals. BMW uses a durable chain, maintained at the correct tension and engineered so well that replacement is not necessary as a scheduled maintenance item. This is just one example of the sophisticated concepts used in the X3. Its highly refined, 260-horsepower, 3.0-liter inline six-cylinder engine is exceptionally quiet. Yet it has the sheer muscle to smoothly launch the X3 from 0-60 in 6.9 seconds.¹ Harness it with your choice of a smooth-shifting 6-speed manual transmission or a 6-speed STEPTRONIC automatic, available as a no-cost option. Whether you're towing a trailer² and need to pass traffic uphill, or you're simply tooling

around town, the free-revving X3 performs confidently and with remarkable efficiency. This is due, in part, to Double-VANOS, which steplessly adjusts the valve timing on both the intake and exhaust camshafts, based on engine speed, temperature and the position of the gas pedal. Building the engine block of a magnesium/aluminum composite saves weight – which also adds to the X3's quick acceleration. BMW's Valvetronic variable valve lift technology lets the engine breathe more effectively, resulting in more power and better fuel economy. And, in keeping with BMW's ongoing commitment to the environment, the engine boasts excellent emissions ratings.

¹ BMW AG test results, manual transmission; 7.1 seconds, STEPTRONIC automatic transmission.

BMW urges you to obey all local speed laws and always wear safety belts.

² Please see the X3 SAV® Owner's Manual for towing guidelines.

Adaptable grip to conquer any road surface.

BMW's xDrive all-wheel-drive system has taken vehicle traction control to new heights. Integrating the use of sensors that relentlessly absorb driving conditions data, this intelligent system offers superb agility and reliability. On smooth, dry roads, the X3 has the feel of a rear-wheel-drive vehicle. But hit a wet uphill curve, for instance, and even before wheelspin can occur, the xDrive system immediately recognizes any need for a change in power distribution. Almost

instantaneously, it can send more torque to the front axle in order to achieve optimal stability. Should one wheel on an axle spin faster than the other, the brakes automatically engage as needed to bring all wheels back in sync. At any given moment, xDrive is working hard, shifting drive power, reducing over- or understeer, enhancing agility, and ensuring the best possible traction. Thanks to xDrive, the X3's driving dynamics reach a thrilling standard never before experienced.



Sudden bends in an unfamiliar road can make for challenging driving. But changing weather conditions can turn even the most familiar street into an obstacle course. xDrive all-wheel drive and Dynamic Stability Control (DSC) are always at work, helping to keep your BMW stable, responsive and controllable at all times. This is what BMW calls active safety.

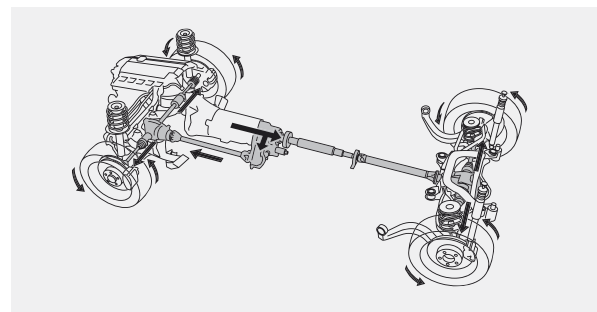

By using readings from the DSC sensors and the gas pedal, BMW's xDrive intelligent all-wheel-drive system permanently monitors the vehicle's driving condition. This data is then used to vary power distribution between the two axles, ensuring agile, neutral and forgiving handling at all times.



There's more to stability than just all-wheel drive.

In addition to xDrive intelligent all-wheel drive, the X3 is packed with an amazing number of innovative systems, all designed to help you maintain traction and stability, to remain in confident control. For example, when you slam on the brakes, Dynamic Brake Control (DBC) reinforces your effort. At the same time, the Adaptive Brake Lights illuminate, signaling the intensity of your braking action, and alerting drivers who follow to slow down quickly.

Dynamic Stability Control (DSC) monitors many factors, including vehicle speed, steering wheel angle, body rotation and more, to determine where you want to go and where you are actually headed. If it detects wheelspin or over- or understeer, DSC is designed to selectively assist the wheel(s) needing help. It can modulate ABS

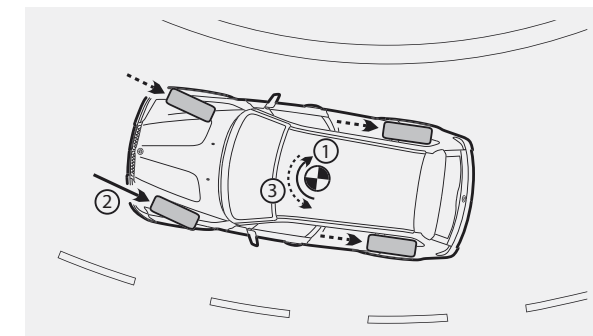

Serious drivers know: when you brake, the pressure comes off the rear wheels, causing the vehicle to swerve inward (oversteer) when turning (1). Cornering Brake Control (CBC) counteracts this action by regulating brake pressure independently of the ABS system (2), creating stabilizing counter-torque (3).

brakes at all four wheels, independently, while reducing engine power. This helps maintain control and vehicle stability, even on bad roads.

In the X3, DSC is equipped with four features:

- 1-**Brake Stand-by:** After suddenly removing your foot from the throttle, DSC pre-tenses the brake calipers for quicker stopping action.
- 2-**Brake Drying:** When your wipers are on and sensors detect moisture, DSC periodically brings the brake pads into contact with the rotors, to eliminate accumulated moisture and help dry them.
- 3-**Start-off Assistant:** When you're stopped on a hill, DSC helps keep the X3 from rolling backwards when you release the brake.
- 4-**Brake Fade Compensation:** In long descents when brakes heat up, DSC applies the brakes with more force with the same pedal action.

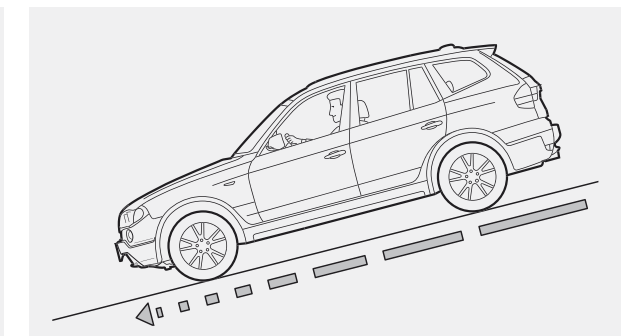

Hill Descent Control (HDC) lets the BMW X3 tackle steep downhill slopes with ease, while it helps stabilize the X3's handling. When you engage HDC, it automatically applies the brakes and slows the engine, keeping your speed constant without riding the brakes.

Tested tough on safety.

The X3's unitized steel body is designed for stability and torsional rigidity. This plays an important role in dynamic handling and helps create a highly protective safety cage. All joints are precision-welded for exceptional durability. At higher speeds, impact energy is directed around the cabin; structural supports deform in a predetermined pattern, helping to protect the occupants.

BMW conducts extensive offset-crash testing where only a portion of the front makes contact with the test barrier, so it must withstand higher energy forces per square inch. The 2009 X3 received the TOP SAFETY PICK Award from the Insurance Institute for Highway Safety (IIHS) for its performance in three critical tests.¹ Every BMW tested by the IIHS has received a top frontal-offset impact rating, based on how well its passive safety features helped protect occupants in a crash.

¹ High-Speed Frontal Offset and Side Impact crash tests, as well as Rear Crash Protection/Head Restraints. Vehicles are required to offer stability control in order to receive the TOP SAFETY PICK.

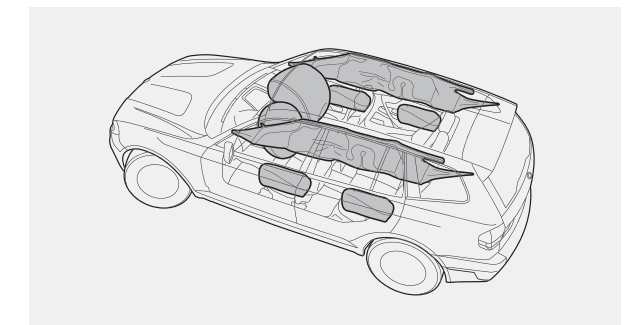

The X3 offers a full complement of airbags, front and rear. BMW's HPS (Head Protection System) helps cushion and protect the heads of occupants seated by the doors.

Shown with optional rear-door-mounted side-impact airbags. Please note: These pictures of airbags are for illustrative purposes only. Depending upon the type of accident, none, some or all airbags may deploy.

Please refer to the Combinations chart on page 35 for details on limitations and exclusivity when selecting X3 SAV® exterior paint colors, upholstery colors and materials.

Paints

300 Alpine White Non-metallic

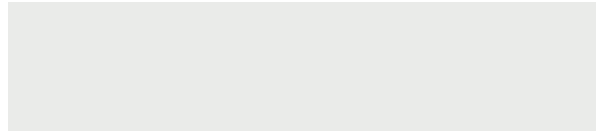

668 Jet Black Non-metallic



354 Titanium Silver Metallic

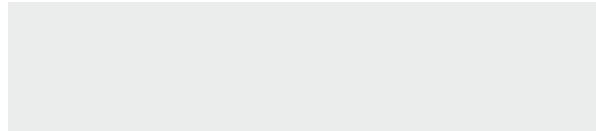

A53 Platinum Bronze Metallic



A52 Space Gray Metallic



A51 Montego Blue Metallic



A35 Monaco Blue Metallic



A70 Mineral Green Metallic



475 Black Sapphire Metallic



A82 Vermilion Red Metallic



Upholsteries

KCSN Sand Beige Sensatec Leatherette



KCSW Black Sensatec Leatherette



LUCX Oyster Nevada Leather



LUSN Sand Beige Nevada Leather



LUD3 Saddle Brown Nevada Leather



LUSW Black Nevada Leather

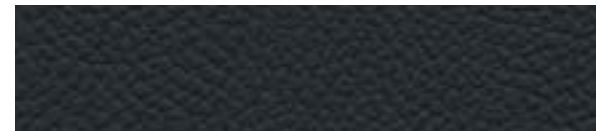

Recommended color combinations

Interior colors	Sensatec Leatherette ¹		Nevada Leather ²			
Upholstery colors	Sand Beige	Black	Oyster	Sand Beige	Saddle Brown	Black
Exterior colors						
300 Alpine White Non-metallic ³	●	●	●	●	●	●
668 Jet Black Non-metallic ³	●	●	●	●	●	●
354 Titanium Silver Metallic ⁵	●	●	●	●	●	●
A53 Platinum Bronze Metallic ^{4, 5}	●	●	●	●	●	●
A52 Space Gray Metallic ⁵	●	●	●	●	●	●
A51 Montego Blue Metallic ⁵	●	●	●	●	●	●
A35 Monaco Blue Metallic ⁵	●	●	●	●	●	●
A70 Mineral Green Metallic ^{4, 5}	●	●	●	●	●	●
475 Black Sapphire Metallic ⁵	●	●	●	●	●	●
A82 Vermilion Red Metallic ^{4, 5}	●	●	●	●	●	●
Interior trims						
4A3 Light Burl Walnut Wood (Standard)						
4BP Light Poplar Wood (No-cost option)						
4AS Gray Poplar Wood (No-cost option)						

¹ Standard. Not available with Premium Package.
² Optional. Included in Premium Package.
³ Non-metallic exterior paint: Standard.
⁴ Platinum Bronze Metallic, Mineral Green Metallic, Vermilion Red Metallic: Not available with Sport Package.
⁵ Metallic exterior paint: Optional.

The pages in this section of the brochure show available colors and materials for the BMW X3 SAV.® Use these samples to compare paint, upholstery and trim colors and combinations. Please note that these samples are representations; they are not exact

reproductions. To see the actual colors, visit your local BMW center. They will be happy to show you original samples and assist you with special requests.

Interior trims

4A3 Light Burl Walnut Wood



4BP Light Poplar Wood



4AS Gray Poplar Wood



Please refer to the Combinations chart on the facing page for details on limitations and exclusivity when selecting X3 SAV® exterior paint colors, upholstery colors and materials.



What color is freedom?

Nothing is more personal than your choice in color. That's why BMW gives you the freedom to mix and match virtually any and every X3 paint, upholstery and trim until it's a true reflection of you. Suppose you opted for Oyster Nevada Leather upholstery, Gray Poplar Wood interior trim and Mineral Green Metallic exterior.

What you would end up with is the elegant vehicle shown here. It's a look that's equally at home around town and on the town—not to mention over the dusty trail. What's your vision of all-road freedom? Chances are, you'll find your true colors in an X3.

Mineral Green Metallic paint, shown above, is an optional X3 exterior color with an intriguing character that is complemented by an Oyster Nevada Leather interior, accented in Gray Poplar Wood trim.





□ **Xenon Adaptive Headlights** optimize road illumination when the X3 enters a curve or bend, helping to enhance safety when driving at night. Sensors continuously monitor the angle of the steering wheel, the vehicle's speed, yaw and other factors to determine the direction in which the X3 is heading. The headlights swivel accordingly, up to 15 degrees left or right. **Xenon low- and high-beam headlights** illuminate the road ahead and to the side with brilliant clarity. Includes auto-leveling to adjust for varying passenger and cargo loads. The Corona headlight-rings that circle both headlights and high beams also act separately as Daytime Running Lights and parking lights. (Shown with optional Cold Weather Package.)



■ **Halogen free-form foglights** are cleanly integrated into the front air dam, illuminating the road ahead in bad weather and poor visibility.



■ **White indicator lights** add a fresh, dynamic look when lit, while sending a clear signal to other drivers. The orange reflectors, positioned on the forward part of the fender, add to the X3's sporty design.



■ **Roof rails**, blending harmoniously with the X3's design, provide the foundation for BMW's (accessory) multi-functional roof support system.



■ **Rain sensor** uses infrared light to measure the amount of rain. When the wipers are in the intermittent mode, the rain sensor automatically adjusts the windshield-wiping interval as needed. **Automatic headlight control** (not shown), included with rain sensor, activates headlights by means of a sensor that responds to darkness.



■ **Rear window wiper** with adjustable, intermittent wipe feature keeps the rear window clear for enhanced visibility in wet weather.



■ **Additional brake light**, above the rear hatch, gives drivers further back an advance warning that you are applying the brakes.



□ **Power-adjustable folding exterior side-view mirrors**, in matching body color, automatically dim when reflecting bright lights, helping to eliminate glare when driving at night. (Included in Premium Package.)



■ **Adaptive Brake Lights** increase vehicle visibility and signal the intensity of your braking action. When the vehicle detects panic stopping, this feature activates additional brake light surfaces, warning following traffic to quickly slow down.



□ **Park Distance Control** uses ultrasonic sensors in the front and rear bumpers to help you judge the distance to other cars and unseen objects when parking. The beeping becomes faster as your bumper approaches the object, turning into a constant tone when the distance is less than 12 inches.



□ Dual-glass-panel **Panoramic moonroof** features fully electric slide and lift control. Includes trap release, comfort opening/closing function, a wind deflector to help keep the wind out, and an electric sun shade to help shield cabin from excessive heat. (Included in Premium Package.)



■ **V Spoke (Style 279)** 17 x 8.0 light alloy wheels and 235/55 **all-season tires** are standard on the X3 xDrive30i.



□ **Privacy glass** in the rear and rear side windows enhances passenger privacy, while it reduces sun glare and interior heat. (Included in Sport Activity Package.)



■ Dual bright chrome **exhaust tips** stand out and add an attractive touch to the X3 s exhaust system.



□ **Y Spoke (Style 280)** 18 x 8.0 light alloy wheels and 235/50 **all-season tires** are available as an option to the standard 17" wheel. (Included in Sport Activity Package.)



□ **Double Spoke (Style 192M)** 18 x 8.0 light alloy wheels and 235/50 **all-season tires** are included in the Sport Package.



□ **Y Spoke (Style 191M)** 19 x 8.5 front, 19 x 9.0 rear light alloy wheels and 235/45 front and 255/40 rear **performance tires**¹ are available as an option when ordering the Sport Package.

¹ Due to low-profile tires, please note: wheels, tires and suspension parts are more susceptible to road hazard and consequential damages. Performance tires not recommended for driving in ice and snow conditions.



□ **16-way power Comfort seats¹** for the driver and front passenger provide optimum lateral support during tight cornering thanks to specially padded, highly contoured side bolsters while remaining exceptionally comfortable when driving over long distances. The seats have individual power adjustment for seat height, backrest angle, seat bottom angle, forward/backward position, and thigh support.



■ **Instrument panel** has analog display for speedometer and tachometer with integrated fuel and engine temperature gauges. Also includes an LCD display for mileage, trip odometer, and on-board computer (if so equipped). When parking lights or headlights are on, the gauges are in an easy-to-read red.



■ **6-speed manual transmission²** delivers a precise, athletic feel that's responsive to your personal driving style. This is due, in part, to the synchronization of shifts from neutral to each gear.



□ The **Navigation system** uses the GPS (Global Positioning System) satellites and BMW technology to help show and tell the way to your destination. The 16:9 display folds neatly into the dash when not in use.



■ **BMW anti-theft AM/FM stereo/CD/MP3 audio system** produces rich sound through eight hi-fi speakers. MP3-capable; includes Radio Data System (RDS), Auto-Store and 3-channel FM diversity antenna system, and compatible with auxiliary audio input adaptor for audio connection of portable music players.



□ **Premium anti-theft AM/FM stereo/CD/MP3 sound system** offers outstanding sound through eight upgraded speakers and an upgraded amplifier, as well as vehicle-speed-sensitive equalization. DSP (Digital Sound Processor) can make the interior sound like a jazz club, concert hall or cathedral.



□ **Heated steering wheel** rim quickly warms up at just the touch of a button – a welcome amenity in cold weather. (Not available with Sport Package.)



□ **Retractable cargo net** helps keep pets and cargo securely away from the passenger area. Net can be anchored behind the back seats; when both back seats are folded, it can be anchored behind the front seats. When not in use, the luggage net housing can easily be removed.



□ **BMW Assist³ and Bluetooth®** system offers hands-free calling through your BMW-approved Bluetooth phone. The BMW Assist Safety Plan is included for four years, providing Automatic Collision Notification, Emergency and Roadside Assistance, Door Unlock, Stolen Vehicle Recovery and more.

¹ Comfort seats not available with Sensatec Leatherette upholstery.

² 6-speed STEPTRONIC automatic transmission available as a no-cost option.

³ The optional Convenience Plan offers Directions, Traffic, Weather and Critical Calling services. See page 56 for details of standard and optional services available with BMW Assist.

Premium Package: The Premium Package adds to the pleasures of your X3 with the open-air feeling of a dual-glass-panel Panoramic moonroof. You'll appreciate the comfort of four-way lumbar support in front seats upholstered in Nevada Leather; and the convenience and peace of mind of BMW Assist™ with Bluetooth® wireless communication system. Automatic-dimming mirrors and a digital compass add to the pleasure of any trip. And the BMW Universal transceiver eliminates the need for multiple remote controls to activate garage-door openers, home lighting systems, etc., outside the vehicle.

See page 52 for a detailed listing of Premium Package components.



Dual-glass-panel **Panoramic moonroof** features fully electric slide and lift control. Includes trap release, comfort opening/closing function, a wind deflector to help keep the wind out, and an electric sun shade to help shield cabin from excessive heat.

Cold Weather Package: Get to the slopes or just get around town in added comfort with the X3 Cold Weather Package. Both front and rear passengers will enjoy the pleasure of variably heated seats. High-intensity retractable headlight washers help maintain optimal nighttime visibility in all weather and driving conditions, and the cargo bag is a must for protecting skis, poles and other long objects.

See page 52 for a detailed listing of Cold Weather Package components.



Cargo bag allows for clean transport of up to four pairs of skis with up to four occupants in the car; whenever the cargo bag is not in use, it remains stored conveniently and out of sight behind the rear center armrest. (Upon BMW X3 SAV® delivery, the cargo bag shown is detached and stored beneath the load floor in the rear cargo area.)



Lumbar support for front seats adds four-way power-adjustable comfort for the lower back. Lumbar support can be adjusted up/down and in/out.



Nevada Leather upholstery, available in a choice of four colors, cradles driver and passengers in softly gathered comfort. Durable and easy to maintain, Nevada Leather adds elegance and refinement. (Shown: no-cost option STEPTRONIC automatic transmission.)



The **automatic-dimming inside rear-view mirror** darkens in response to the bright headlights of vehicles behind you. The easy-to-read digital compass, integrated into the mirror, is a convenient way to constantly keep your bearings while driving, and upon arriving home, the BMW Universal garage-door opener offers convenient remote functions, such as opening garage doors or turning on household lights.



BMW Assist¹ and Bluetooth system offers hands-free calling through your BMW-approved Bluetooth phone. The BMW Assist Safety Plan is included for four years, providing Automatic Collision Notification, Emergency and Roadside Assistance, Door Unlock, Stolen Vehicle Recovery and more. The optional Convenience Plan offers Directions, Traffic, Weather and Critical Calling services.

¹See page 56 for details of standard and optional services available with BMW Assist.



Power-folding exterior side-view mirrors automatically dim when reflecting bright lights, helping to eliminate glare when driving at night.



Floor cargo rails are designed for use with accessory storage racks for clean, safe storage of items in the cargo area. **Luggage compartment bike rails** (sold separately as a BMW accessory) secure the frames after removing the front wheels. NOTE: Bicycles shown are not sold with the X3 SAV.®



Heated front seats are a welcome feature in cooler weather. With the touch of a button, driver and front passenger can individually select from three heat settings.



Heated rear seats are a rare pleasure. Both the seat and the backrest of the two outer seats can be set for toasty warmth.



High-intensity retractable headlight washers help keep lights clean of ice, mud, road salt and other coatings, for maximum road lighting and enhanced driving visibility.

Sport Package:¹ Make the most of the fun-loving capabilities of the X3 xDrive30i by adding the optional Sport Package. This adds sport suspension calibration² and 18" light alloy wheels with all-season tires, enhancing the X3's performance characteristics. Its looks become even bolder and more purposeful with a full-body aerodynamic kit, including body-color side skirts and front and rear bumpers; exterior Shadowline trim completes the effect. Inside, front sport seats hold you tight as you navigate turns, gripping the three-spoke leather-wrapped M Sport steering wheel. And for an even more eye-catching look and heightened performance, optional Y Spoke (Style 191M) 19 x 8.5 front and 19 x 9.0 rear light alloy wheels with 235/45 front and 255/40 rear performance tires³ are available.

See page 52 for a detailed listing of Sport Package components, and the page 35 Recommended color combinations chart for exterior paint color restrictions when ordering the X3 xDrive30i with optional Sport Package.



Full-body aerodynamic kit emphasizes the X3 xDrive30i's dynamic appearance. The body-color front and rear bumpers and side skirts underscore the purposeful look, while Shadowline trim adds a sporty touch.

Sport Activity Package: Add a dash of sporty style to your daily drive with the X3 Sport Activity Package. Set a brisk pace for yourself with the three-spoke sport steering wheel. Eye-catching light alloy wheels, brushed aluminum running boards and purposeful-looking Shadowline trim add to the sleek impression as you streak by. But keep the world from peeking in at your passengers with sun glare- and heat-reducing privacy glass that surrounds the rear compartment.



3-spoke leather-wrapped multi-function sport steering wheel offers controls for audio system, cruise control and (accessory) phone.

European dashboard shown.



Double Spoke (Style 192M) 18 x 8.0 light alloy wheels and 235/50 all-season tires. (Included in the Sport Package.)



Y Spoke (Style 191M) light alloy wheels, 19 x 8.5 front, 19 x 9.0 rear; 235/45 front and 255/40 rear performance tires.³ (Optional with Sport Package.)



3-spoke leather-wrapped multi-function M Sport steering wheel delivers confident grip when taking tight corners, and remains comfortable when driving long distances.



Front sport seats are designed to enhance the driving experience. Multiple adjustments add to comfort over long distances; specially bolstered side padding helps hold occupants firmly in place during tight cornering.



Aluminum running boards are made of brushed and eloxy-plated aluminum with rubber inserts for a sporty look.



Privacy glass in the rear and rear side windows enhances passenger privacy, while reducing sun glare and interior heat.

Shadowline trim adds a bolder, sporty look to front and rear side-window frames, window recess finishers, and door-sill trim strips.



Y Spoke (Style 280) 18 x 8.0 alloy wheels and 235/50 all-season tires are available as an option to the standard 17" wheel.

¹ Requires optional Nevada Leather upholstery or Premium Package.

² Note: Sport suspension consists of stiffer springs and anti-roll bars. While these features improve the sporty handling of the X3, they can also create a firmer ride, which may not be acceptable for all customers.

³ Due to low-profile tires, please note: wheels, tires and suspension parts are more susceptible to road hazard and consequential damages. Performance tires not recommended for driving in ice and snow conditions.



■ **Automatic Differential Brake (ADB-X)** is similar to the function of a differential lock, braking each wheel independently, as needed. As soon as wheelspin is detected at any wheel, ADB-X applies that brake automatically until the wheel regains traction. DSC assists ADB-X by modulating the amount of power sent to each wheel; with DSC turned off, full power continually flows to all four wheels.

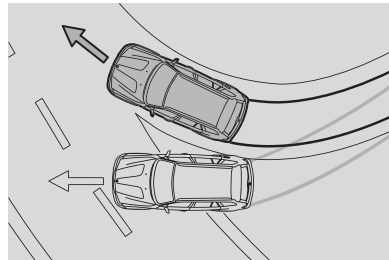

■ **Dynamic Stability Control (DSC)** provides remarkable tenacity on slippery road surfaces. If the system senses over- or understeer, it modulates engine power and can apply brakes individually to help keep the vehicle under control and going in the intended direction.

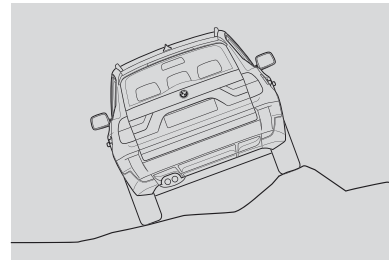

■ The **roll-over sensor** is networked with the Dynamic Stability Control system to enable critical situations to be identified faster and more effectively. If the vehicle threatens to overturn, airbags and safety-belt pretensioners are deployed immediately for maximum passive safety.

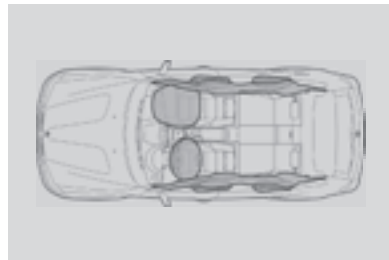

■ In the event of a collision, only the **airbags** that are needed are deployed. For the driver and front passenger, this includes front airbags, door-mounted side-impact airbags, and Head Protection System (HPS). For rear-seat passengers this includes HPS and optional rear side-impact airbags.

Please note: These pictures of airbags are for illustrative purposes only. Depending upon the type of accident, none, some or all airbags may deploy.



■ In the event of a severe frontal collision, **automatic safety-belt pretensioners** automatically tighten the lap and shoulder belts around front-seat occupants. **Always wear your safety belt and always place children in the rear seat.**

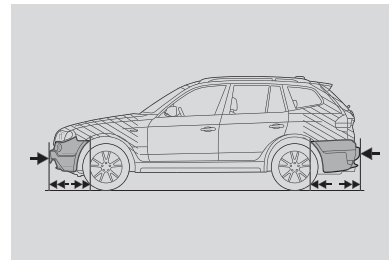

■ **Impact-absorbing bumpers** and compressible front and rear crush tubes help absorb the force of impact in collisions up to 9 mph, minimizing damage to the vehicle's body and simplifying repairs. Only at higher impact speeds do structural supports begin to deform, dissipating impact energy to help protect occupants.

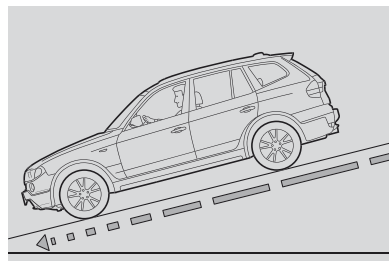

■ **Hill Descent Control (HDC)** helps the X3 drive down steep hills without having to ride the brake. By pressing the HDC button, the system keeps the X3's speed under control automatically.

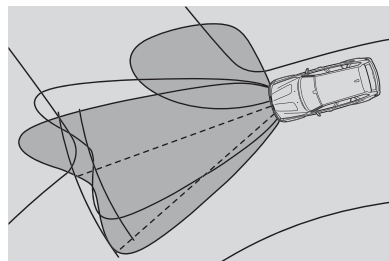

□ **Xenon Adaptive Headlights** with Corona headlight-rings automatically swivel to follow the curves of the road. The system uses data from on-board sensors and the steering wheel angle to determine the car's direction, then adjusts the headlights accordingly, for excellent nighttime vision.

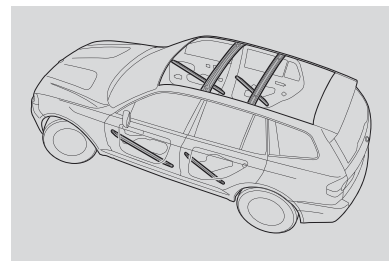

■ **BMW's door anchoring system** includes reinforcing bars with hook-like members within each door. In a serious side collision, the bars hook the door to the body, locking them together to make a more rigid passenger cell. When the pressure is released, the anchoring system is designed to disengage so that the doors can be opened (unless further damage from the impact prevents them from opening).

Performance and efficiency	X3 xDrive30i
3.0-liter dual overhead cam (DOHC), 260-horsepower, 24-valve inline 6-cylinder engine with composite magnesium/aluminum engine block, Valvetronic, and Double-VANOS steplessly variable valve timing	●
Electronic throttle control	●
Dual resonance intake system	●
6-speed manual transmission	●
6-speed STEPTRONIC automatic transmission with Adaptive Transmission Control (no-cost option)	○

Handling, ride and braking	X3 xDrive30i
xDrive all-wheel-drive system	●
Dynamic Stability Control (DSC), including Brake Drying, Brake Stand-by, Start-off Assistant and Brake Fade Compensation	●
Hill Descent Control (HDC)	●
Engine-speed-sensitive power steering	●
Servotronic vehicle-speed-sensitive power steering	○
Unitary body structure with independent suspension	●
Gas-pressure shock absorbers	●
Front and rear anti-roll (stabilizer) bars	●
4-wheel ventilated anti-lock disc brakes with Dynamic Brake Control	●
Sport suspension calibration ¹	□

Exterior	X3 xDrive30i
V Spoke (Style 279) 17 x 8.0 light alloy wheels, 235/55 all-season tires	●
Y Spoke (Style 280) 18 x 8.0 light alloy wheels, 235/50 all-season tires (not available with Sport Package)	◆
Double Spoke (Style 192M) 18 x 8.0 light alloy wheels, 235/50 all-season tires	□
Y Spoke (Style 191M) light alloy wheels, 19 x 8.5 front, 19 x 9.0 rear; 235/45 front, 255/40 rear performance tires ²	○
Space-saver spare wheel and tire	●
Xenon Adaptive Headlights with auto-leveling, and Corona headlight-rings	○
Halogen free-form foglights	●
Retractable headlight washer system	★
Door handles in matching body color	●
Full body-color aerodynamic kit with painted side skirts	□
Shadowline exterior trim	□/◆
Privacy glass	○/◆
Roof rails	●
Metallic paint	○
Chrome tail pipes	●
Power-folding side-view exterior mirrors with automatic-dimming feature	◇
Aluminum running boards	◆

- Standard
- Optional
- Included in Sport Package
- ◇ Included in Premium Package
- ◆ Included in Sport Activity Package
- ★ Included in Cold Weather Package

¹ Note: Sport suspension consists of stiffer springs and anti-roll bars. While these features improve the sporty handling of the X3, they can also create a firmer ride, which may not be acceptable for all customers.
² Sport Package required. Due to low-profile tires, please note: wheels, tires and suspension parts are more susceptible to road hazard and consequential damages. Performance tires not recommended for driving in ice and snow conditions.

Interior seating	X3 xDrive30i
8-way power adjustable front seats with 2-way manual headrests, and driver seat and mirror memory	●
8-way power adjustable front sport seats with 2-way manual thigh support, 2-way manual headrests and driver seat and mirror memory (requires optional Nevada Leather upholstery)	□
Comfort seats, including power lumbar support, headrests and 2-way upper backrest angle adjustment and driver seat and mirror memory (Comfort seats not available with Sensatec Leatherette upholstery)	○
4-way lumbar support for front seats	◇
Sensatec Leatherette upholstery	●
Nevada Leather upholstery	○/◇
Light Poplar Wood trim	▲
Gray Poplar Wood trim	▲
Light Burl Walnut Wood trim	●
Heated front seats	○/★
Heated rear seats	★
3-spoke leather-wrapped multi-function steering wheel with fingertip cruise control	●
3-spoke leather-wrapped multi-function M Sport steering wheel with fingertip cruise control	□
3-spoke leather-wrapped multi-function sport steering wheel with fingertip cruise control	◆
Heated steering wheel (not available with Sport Package)	○
Front center console armrest	●
Storage nets on front seatbacks and in front passenger footwell	●
Two aluminum fastening cargo rails and side storage nets in rear cargo compartment	◇
Split 60/40 fold-down rear seats	●
Cargo bag (upon BMW X3 SAV [®] delivery, the cargo bag is detached and stored beneath the load floor in the rear cargo area)	★

Comfort and convenience	
Vehicle & Key Memory	●
Remote entry, including 2-step unlocking and remote tailgate release	●
Automatic climate control with micro-filter and air recirculation	●
Panoramic moonroof with fully automatic, 2-piece glass panels, power slide and lift control, trap release, wind deflector and power interior sunshade	○/◇
Tilt/telescopic steering wheel column	●
Park Distance Control (PDC), front and rear	○
Rain-sensing windshield wipers with Automatic Headlight Control	●
Automatic-dimming inside rear-view mirror with digital compass	◇
Power front windows with one-touch up/down operation; power rear windows with one-touch down	●
Front/rear map-reading, footwell and visor-mirror lights	●
Locking glovebox with rechargeable take-out flashlight	●
Dual cupholders	●
Retractable cargo net	○
Bluetooth [®] wireless technology (included with Premium Package or BMW Assist [™]) for hands-free calling, capable of downloading virtually an entire phonebook using BMW-approved Bluetooth technology enabled mobile phones ³	○/◇
BMW Universal garage-door opener	◇

- Standard
- Optional
- Included in Sport Package
- ◇ Included in Premium Package
- ★ Included in Cold Weather Package
- ◆ Included in Sport Activity Package
- ▲ No-cost option
- △ BMW center-installed accessory

³Please contact your authorized BMW SAV center for a list of BMW-approved Bluetooth technology enabled mobile phones.

Audio system	X3 xDrive30i
Anti-theft AM/FM stereo/CD/MP3 audio system with 8 speakers, Radio Data System (RDS), Auto-Store, 3-channel FM diversity antenna system and auxiliary audio input adaptor compatible with portable music players	●
Premium sound with DSP (Digital Sound Processor) AM/FM stereo/CD/MP3 audio system with 8 upgraded speakers, upgraded amplification, vehicle-speed-sensitive equalization, and auxiliary audio input adaptor compatible with portable music players	○
Auxiliary audio input for portable music players	●
Pre-wiring for satellite radio	●
SIRIUS Satellite Radio with one-year subscription (for additional information, please visit your authorized BMW SAV center)	△
HD Radio [™] with multicast FM station reception	●

Instrumentation and controls	
Service Interval Indicator with miles-to-service readout	●
Check Control vehicle monitor system with pictogram display	●
Tire Pressure Monitor	●
4-function on-board computer	●
Navigation system with 16:9 display and folding monitor	○

Safety and security	
Automatic Differential Brake (ADB-X)	●
Head Protection System (HPS), front and rear	●
Active Head Restraints in front seats	●
Driver's and passenger's front airbag supplemental restraint system (SRS) with advanced technology: dual-threshold, dual-stage deployment; and front-passenger seat sensors designed to prevent unnecessary airbag deployment	●
Adaptive Brake Lights	●
Front-door-mounted side-impact airbags	●
Rear-door-mounted side-impact airbags	○
BMW's Advanced Safety System for integrated deployment of passive and active safety features	●
Automatic-locking retractors (ALR) on all passenger-seat safety belts (for installation of child restraint seats)	●
LATCH for child-restraint safety seat installation	●
Battery Safety Terminal	●
Central locking system with center console switch (leaves gas filler door unlocked), double-lock feature and 2-step unlocking	●
Coded Driveway Protection	●
Front safety belts with automatic pretensioners	●
Crash sensor that automatically turns on hazard lights and interior lights, and unlocks doors	●
Daytime running lights (via Vehicle Memory system programmed at authorized BMW SAV [®] center)	●
BMW Assist [™] (4 years of service) with Automatic Collision Notification (please visit your authorized BMW SAV [®] center for details on standard and optional services)	○/◇

BMW Services	
BMW Ultimate Service [™] (for complete details on BMW Ultimate Service, visit bmwusa.com/ultimateservice)	●

Premium Package	X3 xDrive30i
Panoramic moonroof with fully automatic, 2-piece glass panels, power slide and lift control, trap release, wind deflector and power interior sunshade	○/◇
Automatic-dimming inside rear-view mirror with digital compass	◇
Automatic-dimming power folding side-view mirrors	◇
BMW Universal garage-door opener	◇
BMW Assist™ (4 years of service) with Bluetooth® integrated wireless communication system ⁴ (please visit your BMW SAV® center for details on BMW Assist standard and optional services)	◇
Nevada Leather upholstery	◇
4-way lumbar support for front seats	◇
Ambient interior lighting	◇
Two aluminum fastening cargo rails and side storage nets in rear cargo compartment	◇

Sport Package (requires optional Nevada Leather upholstery or Premium Package)	
Double Spoke (Style 192M) 18 x 8.0 light alloy wheels, 235/50 all-season tires	□
Y Spoke (Style 191M) light alloy wheels, 19 x 8.5 front, 19 x 9.0 rear; 235/45 front, 255/40 rear performance tires ⁵	○
8-way power adjustable front sport seats with 2-way manual thigh support	□
3-spoke leather-wrapped multi-function M Sport steering wheel	□
Sport suspension calibration ⁶	□
Full body-color aerodynamic kit with painted side skirts	□
Shadowline exterior trim	□

Cold Weather Package	
Cargo bag (upon BMW X3 SAV® delivery, the cargo bag is detached and stored beneath the load floor in the rear cargo area)	★
Heated front seats	★
Heated rear seats	★
Retractable headlight washer system	★

Sport Activity Package	
3-spoke leather-wrapped multi-function sport steering wheel	◆
Y Spoke (Style 280) 18 x 8.0 light alloy wheels, 235/50 all-season tires	◆
Eloxy-plated brushed aluminum running boards	◆
Shadowline exterior trim	◆
Privacy glass	◆

○ Optional
 □ Included in Sport Package
 ◇ Included in Premium Package
 ★ Included in Cold Weather Package
 ◆ Included in Sport Activity Package
 ▲ No-cost option
 △ BMW center-installed accessory

Please refer to the recommended color combinations chart on page 35 for exterior paint color restrictions when ordering X3 SAV with optional Sport Package.

⁴ Please contact your authorized BMW center for a list of BMW-approved Bluetooth technology enabled mobile phones.
⁵ Sport Package required. Due to low-profile tires, please note: wheels, tires and suspension parts are more susceptible to road hazard and consequential damages. Performance tires not recommended for driving in ice and snow conditions. Spare is a space-saver wheel and tire.
⁶ Note: Sport suspension consists of stiffer springs and anti-roll bars. While these features improve the sporty handling of the X3, they can also create a firmer ride, which may not be acceptable for all customers.

Stand-alone Optional Equipment	X3 xDrive30i
6-speed STEPTRONIC automatic transmission with Adaptive Transmission Control (no-cost option)	○
Servotronic vehicle-speed-sensitive power steering	○
Y Spoke (Style 280) 18 x 8.0 light alloy wheels, 235/50 all-season tires (not available with Sport Package)	○
Y Spoke (Style 191M) light alloy wheels, 19 x 8.5 front, 19 x 9.0 rear; 235/45 front, 255/40 rear performance tires ⁵	○
Xenon Adaptive Headlights with auto-leveling, adaptive light control and Corona headlight-rings	○
Panoramic moonroof with fully automatic, 2-piece glass panels, power slide and lift control, trap release, wind deflector and power interior sunshade	○
Privacy glass	○
Metallic paint	○
Nevada Leather upholstery	○
Comfort seats, including power lumbar support, headrests and 2-way upper backrest angle adjustment and driver seat and mirror memory (Comfort seats not available with Sensatec Leatherette upholstery)	○
Light Poplar Wood trim (no-cost option; Light Burl Walnut Wood trim is standard)	▲
Gray Poplar Wood trim (no-cost option; Light Burl Walnut Wood trim is standard)	▲
Heated front seats	○
Heated steering wheel (not available with Sport Package)	○
Park Distance Control (PDC), front and rear	○
Retractable cargo net	○
Premium sound with DSP (Digital Sound Processor) AM/FM stereo/CD/MP3 audio system with 8 upgraded speakers, upgraded amplification, vehicle-speed-sensitive equalization, and auxiliary audio input adaptor compatible with portable music players	○
Navigation system with 16:9 display and folding monitor	○
Rear-door-mounted side-impact airbags	○
BMW Assist™ (4 years of service) with Automatic Collision Notification (please visit your authorized BMW SAV® center for details on standard and optional services)	○

Accessories	
CD changer (6-disc)	△
Alarm system	△
Floor mats	△
Bicycle rack that attaches to cargo rails	△
Trailer hitch (please view X3 Owner s Manual for towing guidelines)	△
Aerodynamic components	△
iPod® Seamless Integration System (for additional information, please visit your authorized BMW SAV center)	△
SIRIUS Satellite Radio with one-year subscription (for additional information, please visit your authorized BMW SAV center)	△

All optional equipment listed is factory-installed.
 For additional requests see the extensive catalog of accessories at your BMW center.

Weight		X3 xDrive30i
Unladen	lbs	4012 (4067)
Weight distribution, front/rear		
Manual transmission	%	50.8/49.2
Automatic transmission	%	50.9/49.1

Engine		
Liter/type		3.0/inline 6
Bore/stroke	inch	3.35/3.46
Nominal output/rpm	hp	260/6600
Max torque/rpm	lb-ft	225/2750
Compression ratio	:1	10.7
Fuel grade		Unleaded premium

Transmission		
Manual gear ratios		
I/II/III	:1	4.35/2.50/1.66
IV/V/VI/R	:1	1.23/1.00/0.85/3.93
Final drive ratio	:1	3.73
Automatic gear ratios		
I/II/III	:1	4.07/2.37/1.55
IV/V/VI/R	:1	1.16/0.85/0.67/3.20
Final drive ratio	:1	4.44

Performance		
Drag coefficient	C _d	0.35
Top speed ¹	mph	130/143 ² (130/142 ²)
Acceleration 0-60 mph ³	sec	6.9 (7.1)
Fuel consumption ⁴		
6-speed manual transmission		
City/Highway	mpg	16/23
6-speed automatic transmission		
City/Highway	mpg	17/24

General		
Maximum payload	lbs	1036
Gross Vehicle Weight Rating GVWR	lbs	5049 (5104)
Roof load limit	lbs	165
Breakover angle @ curb weight	degrees	18°
Angle of approach @ curb weight	degrees	24°
Angle of departure @ curb weight	degrees	21.9°
Ground clearance	inch	8.0
Fording ability	inch	19.7
EPA cargo volume with rear seats folded down	cu ft	71

Figures in () apply to vehicles with automatic transmission.

Wheels		X3 xDrive30i
Tire dimensions	(standard)	235/55 all-season
Wheel dimensions	(standard)	17x8.0
Material		light alloy
Tire dimensions	(Sport Package)	235/50 all-season
Wheel dimensions	(Sport Package)	18x8.0
Material		light alloy

Brakes		
Front Type/Diameter	inch	Ventilated disc/12.8
Rear Type/Diameter	inch	Ventilated disc/12.6

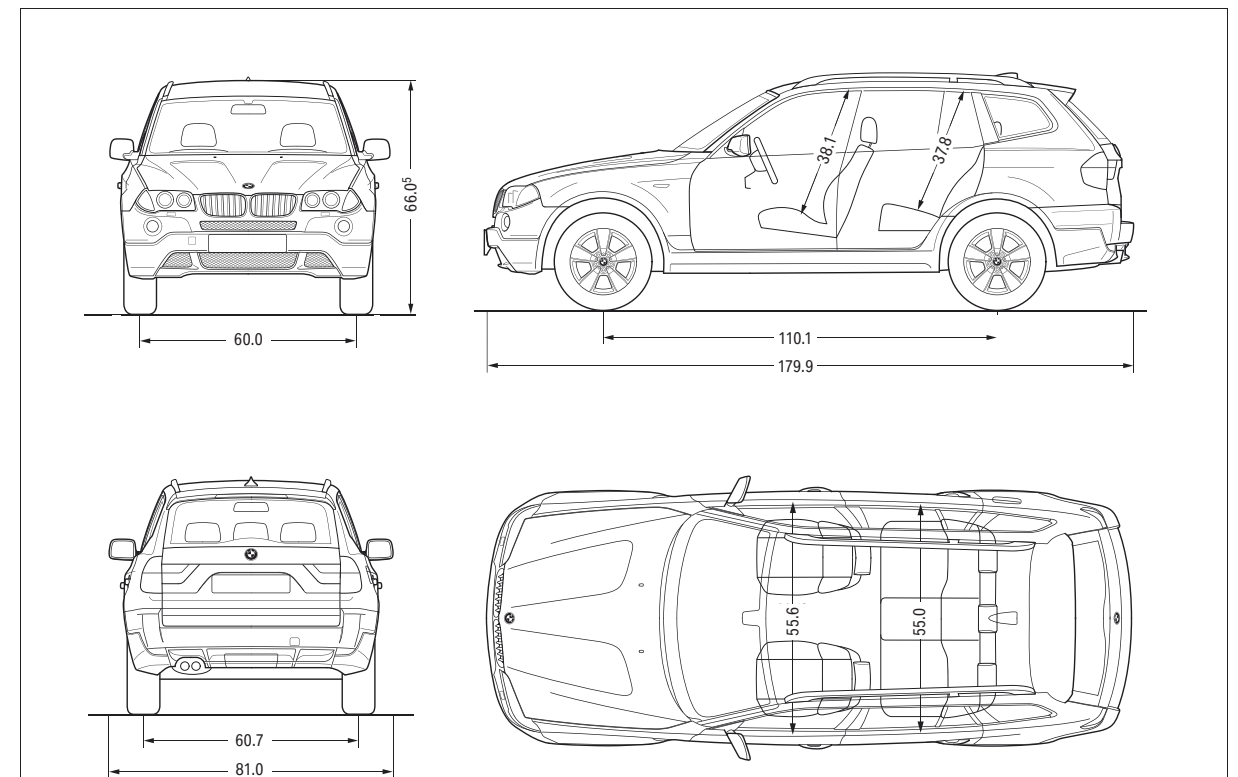

All dimensions are shown in inches.

¹ Top speed limited electronically.

² With optional Y Spoke (Style 191M) alloy wheels and performance tires; requires Sport Package.

³ BMW AG test results. Actual acceleration results may vary, depending on specification of vehicle; road and environmental conditions; testing procedures and driving style. These results should be used for comparison only and verification should not be attempted on public roads.

BMW urges you to obey all posted speed laws and always wear safety belts.

⁴ EPA-estimated figures are for comparison purposes only. Your actual mileage will vary, depending on speed, driving habits, trip length and driving conditions; actual mileage will most likely be lower.

⁵ Includes antenna.

All illustrations and specifications contained in this brochure are based on the latest product information available at the time of printing. BMW reserves the right to make changes at any time, without notice, in colors, materials, equipment, specifications and models. BMW may, subject to legal requirements, determine the Model Year designation of its vehicles. The Model Year designation on any particular model may be longer or shorter than 12 months. Some vehicles pictured may contain non-U.S. equipment. Some models may be shown with optional equipment. While BMW NA makes all reasonable efforts to provide accurate information in this brochure, there is no guarantee or warranty of accuracy. Furthermore, we do not assume any liability for the accuracy or completeness of information presented. This brochure shall not be used or relied upon as a substitute for information that is available from your authorized BMW SAV[®] center. Further information can be obtained from your authorized BMW SAV center or bmwusa.com.

BMW European Delivery: Save money and drive your new BMW on the roads it was designed for.

The new **BMW Welt** (BMW World) delivery and brand-experience center in Munich is bold proof of BMW's passion for design. When you take advantage of the BMW European Delivery Program,¹ this is where you will meet your new BMW in a personalized process that is highly dramatic and totally unforgettable. (You might also realize substantial savings that just may pay for your trip.) While you're there, marvel at the historic BMWs in the Museum; learn about our engineers' newest innovations in the Technology and Design Atelier; and take a tour of the plant to experience firsthand the state-of-the-art methods used to create a BMW. Then comes the unique experience of driving your new BMW on the roads it was designed for. To learn more, visit bmwusa.com/europeandelivery.



BMW Ultimate Service™

At BMW, we believe that a premium ownership experience should feature performance and luxury, as well as safety and convenience. We believe you should be able to drive a BMW to its potential, while enjoying peace of mind and reduced cost of ownership. That's the idea behind BMW Ultimate Service: a suite of comprehensive programs and services that are included in every 2009 and later model year vehicle. The New Vehicle Limited Warranty, the BMW Maintenance Program, and Roadside Assistance come standard, with BMW Assist™ offered as an option. BMW Ultimate Service starts with the **New Vehicle Limited Warranty**, providing you with coverage for the first four years or 50,000 miles, whichever comes first. Additionally, you have 12-year, unlimited-mileage warranty protection against corrosion and rust perforation.² **BMW Maintenance Program** is one of the most comprehensive maintenance programs in its class. We cover all factory-recommended maintenance during the New Vehicle Limited Warranty coverage period. This includes scheduled oil services and inspections. Also covered is the replacement of items that are subject to normal wear and tear, such as brake pads, wiper blade inserts and engine drive belts.³ And, thanks to BMW's advanced engineering, most owners enjoy a well-balanced maintenance schedule, with flexible routine service intervals that can save you time. When your vehicle requires attention, your authorized BMW or BMW SAV® center ensures that it receives only genuine BMW parts – your assurance of exacting quality standards.

BMW Roadside Assistance is provided free of charge for the first four years – with no mileage limit. Call **1-800-332-4BMW (4269)** for friendly on-the-road help, 24/7, anywhere in the United States, Canada and Puerto Rico. This includes everything from flat-tire changes, emergency gasoline and lock-out service, to towing, alternative transportation and even trip-interruption benefits. This service also provides valuable trip-routing advice.

The **BMW Assist™** Safety Plan⁴ is an optional four-year program. You'll enjoy peace of mind knowing that a friendly response specialist is there to help you, 24/7, at just the push of a button. The **Safety Plan** includes Automatic Collision Notification, Emergency Request, Enhanced Roadside Assistance, Door Unlock, Stolen Vehicle Recovery and Customer Relations. And for the ultimate in coverage, add the optional **Convenience Plan**.⁵ You'll enjoy unlimited access to personalized Directions, Traffic and Weather reports. You can make up to four operator-assisted calls per year with Critical Calling if your cell phone is not available, or if its battery is discharged.

For more details on BMW Ultimate Service, visit your preferred BMW or BMW SAV center or log on to bmwusa.com/ultimateservice.

BMW Virtual Center.

If you get the sudden urge to shop for a BMW but your BMW center is closed, there's good news – the BMW Virtual Center is open 24 hours a day! Log on to bmwusa.com, then click on the model series you are interested in. After selecting the BMW that interests you, click on **Build Your Own**. Configure the BMW of your dreams, and see what the monthly payments would be. You can even send the specifications to your authorized BMW or BMW SAV center, apply for financing, or request a test drive – all online!

BMW Financial Services.

Arranging to buy or lease a BMW is easier than you may think. Your authorized BMW SAV center offers leasing and financing to suit your personal needs through BMW Financial Services.⁶ Start the process at our website, where you can build your dream vehicle, get an estimate on a monthly lease or financing payment, submit a credit application to BMW Financial Services – and get approval – all online!⁶ To find out how BMW Financial Services can help put you behind the wheel of your favorite BMW model, log on to bmwusa.com/fs or call, toll-free, **1-800-578-5000**.

BMW Publications and Media Gallery.

Sent to new owners and lessees several times a year, **BMW Magazine** is a fascinating view of the latest events and products in the world of BMW, including personality profiles, travel reviews, and the latest BMW technologies. You can read articles from **BMW Magazine**, as well as **Mdriver** and **Inside Track**, on the BMW website at bmwusa.com in the Media Gallery/News Feed, found in the Experience section. Here you can also view featured videos and images, read recent news articles, and download BMW wallpapers. For more information, call Customer Assistance at **1-800-334-4BMW (4269)** or visit BMW online at bmwusa.com.

¹ Not all models available for BMW European Delivery Program. Please go to bmwusa.com or visit your local authorized BMW or BMW SAV center for details.

² See your authorized BMW SAV center for details on these limited warranties.

³ The BMW Maintenance Program covers factory-recommended maintenance services as determined by the Service Interval Indicator for all new eligible MY 2004 and later BMW SAV vehicles. Specific additional items that need replacement due to normal wear and tear are also covered. The maintenance coverage period is for the first 4 years or 50,000 miles, whichever comes first. Exclusions from coverage include: gasoline, gasoline additives, windshield washer fluid and additives, tires, wheels, wheel alignment and tire balancing. All work must be performed by an authorized BMW SAV center. See the Service and Warranty Information booklet for specific terms, conditions and limitations. Further information can also be obtained from your local authorized BMW SAV center.

⁴ The BMW Assist and Bluetooth Hands-free Calling system with 4 years of Safety Plan services is optional or included in the Premium Package. In order to receive BMW Assist services, a subscriber agreement must be completed and transferred to the BMW Assist Response Center. GPS and underlying wireless services must be available and functioning; vehicle ignition must be turned on (except for Door Unlock and Stolen Vehicle recovery), battery charged and connected and vehicle's electrical system operational; services may be limited to certain geographic areas. Call toll-free **1-888-333-6118**, log on to bmwassist.com, or visit your BMW SAV center for additional program details. Services are subject to the terms and conditions of your subscriber agreement.

⁵ Requires BMW Assist Safety Plan subscription. Services are subject to the terms and conditions of your subscriber agreement. Please go to bmwassist.com for additional details on the optional Convenience Plan.

⁶ Subject to credit approval and other terms and conditions.

An easy way to make life immediately more enjoyable: Original BMW Accessories.



The **BMW Roof Box 460** is available in Silver or Black, or painted to match your X3. The innovative design lets you load it from either side; anti-theft triple central locking on both sides provides reassuring security.

If driving a BMW adds to the quality of life, Original BMW Accessories personalize the pleasure. Want to set your BMW apart? Add unique wheels, sporty Aerodynamic components, or even an elegant wood gearshift knob. Do you lead an active life? BMW roof rack systems let you easily transport bikes, skis, snowboards and more. From start

(Advanced Battery Charging System) to finish (BMW Vehicle Care Products), Original BMW Accessories turn your BMW into a sporty, practical and even luxurious reflection of yourself.

For detailed information on ordering Original BMW Accessories, please contact your authorized BMW SAV® center. Some details shown in photographs may not be available in the United States.



Dual Rear Seat Entertainment System offers two 7" TFT-LCD monitors, Dual DVD players, two wireless headphones and wireless remote.



Rear-Mounted Bicycle Carrier carries two locked bicycles; an extension set holds a third. Even when in use, tailgate can be opened.



Rear View Camera automatically turns on in reverse gear, letting you see objects behind the X3. (Optional Navigation system required.)

BMW and the environment.

BMW is a strong proponent of the environment and social responsibility. It is important to manage the earth's resources responsibly, and not jeopardize the needs of future generations. That is why BMW makes vehicles that minimize adverse environmental impact, from production (pollution prevention and waste minimization at the plant) through owner use (low emissions) to eventual disposal (easy drainability of all fluid-related components and easy neutralization of all pyrotechnic devices).

This effort has been recognized worldwide and, as a result, we are pleased to have received numerous environmental honors. In the U.S., for example, the Environmental Protection Agency accepted BMW's Spartanburg, SC production and manufacturing facility as a charter member of the agency's National Environmental Performance Track. Internationally, BMW AG—the parent company of both BMW of North America and BMW Manufacturing Co., Spartanburg, SC—was the first automotive company to be represented on the Dow Jones Sustainability Group Index, and has remained on the Index ever since. At BMW, we strive for high performance in everything we do.

U.S. Importer: BMW of North America, LLC, Woodcliff Lake, NJ 07677. All illustrations and specifications contained in this brochure are based on the latest product information available at the time of printing. BMW reserves the right to make changes at any time, without notice, in colors, materials, equipment, specifications and models. BMW may, subject to legal requirements, determine the Model Year designation of its vehicles. The Model Year designation on any particular model may be longer or shorter than 12 months. Some vehicles pictured may contain non-U.S. equipment. Some models may be shown with optional equipment. While BMW NA makes all reasonable efforts to provide accurate information in this brochure, there is no guarantee or warranty of accuracy. Furthermore, we do not assume any liability for the accuracy or completeness of information presented. This brochure shall not be used or relied upon as a substitute for information that is available from your authorized BMW SAV® center. Further information can be obtained from your authorized BMW SAV center or bmwusa.com.

©2009 BMW of North America, LLC. Not to be reproduced wholly or in part without written permission of BMW NA. The BMW name, logo, model names, SAV and Sports Activity Vehicle are registered trademarks.

The Bluetooth word mark and logos are owned by the Bluetooth SIG, Inc. and any use of such marks by BMW is under license. iPod is a registered trademark of Apple Inc. Other trademarks and trade names are those of their respective owners.

BMW recommends 

More about BMW

bmwusa.com
1-800-334-4BMW



The Ultimate
Driving Machine®

