

1973 FORD PICKUPS



1973 Ford pickups are designed with so many innovations, refinements and useful features, they start a whole new generation of better ideas. New generation options, too, including the big 460-cu. in. V-8* for exceptional performance with heavy camper loads.

STARTING a **NEW GENERATION** OF BETTER IDEAS

73 FORD PICKUPS

Big "new generation" cabs are the roomiest, most comfortable and carlike of any conventional pickup Ford has ever built! Their stretch-out spaciousness is matched by handsome new styling in three great lines: Custom, Ranger and Ranger XLT. Deep-foam seating comfort is standard on the value-packed Custom, while even more quiet and luxury are yours in the new Ranger and Ranger XLT models. Ranger and Ranger XLT are heavily insulated and beautifully finished in six interior trim colors.

Whichever model you choose, a gleaming bright grille and front bumper are standard, and so is Twin-I-Beam independent front suspension, the exclusive feature that contributes so much to Ford's works-like-a-truck, rides-like-a-car design. Twin-I-Beam suspension is now complemented with new, long and 2½-in. wide rear leaf springs (F-100) and longer wheelbases (117 in. with 6¾-ft. box and 133 in. with 8-ft. box) to further improve ride. And a totally new 140-in. long wheelbase Super Camper Special model with 8-ft. pickup box is designed to give you better-than-ever ride and stability with big slide-in camper bodies (pages 12 & 13).

Ford light-duty conventional trucks are offered in F-100, F-250 and F-350 Series. GVW ranges for these series are F-100—4550 lb. to 5500 lb., F-250—6200 lb. to 8100 lb., and F-350—6600 lb. to 10,000 lb. Ford F-100 and 250 Series are available in Styleside or Flareside pickups and chassis-cabs. F-350's are offered in Super Camper Special pickups, Styleside pickups and single- or dual-rear wheel stakes and chassis-cabs. A 240-cu. in. Six is standard in F-100; 300-cu. in. Six in F-250 and F-350 (360-cu. in. V-8 in F-350 Super Camper and Styleside pickup). A 302-cu. in. V-8 is optional in F-100 4 x 2. Also available are the 360-cu. in. V-8 (all series) and 390-cu. in. V-8 (4 x 2's only). High-performance 460 V-8* is optional in F-250 and F-350 4 x 2's.

Ford F-Series 4 x 4's are designed with the ground clearance and strong components needed to tame tough terrain. They are available as 6¾-ft. Stylesides and 8-ft. Styleside or Flareside pickups and chassis-cabs. The F-100 4 x 4 (max. GVW 5600 lb.) has Ford's exclusive easy-riding Mono-Beam front suspension with coil springs, radius rods, track bar and steering-linkage shock absorber. F-250 4 x 4 (max. GVW 7700 lb.) has heavy-duty front suspension with long leaf springs and lube-free shackles.

New 4 x 4 options include Ford's SelectShift Cruise-O-Matic for fully automatic or manual shifting and power steering for greater handling ease.

*Available February 1973

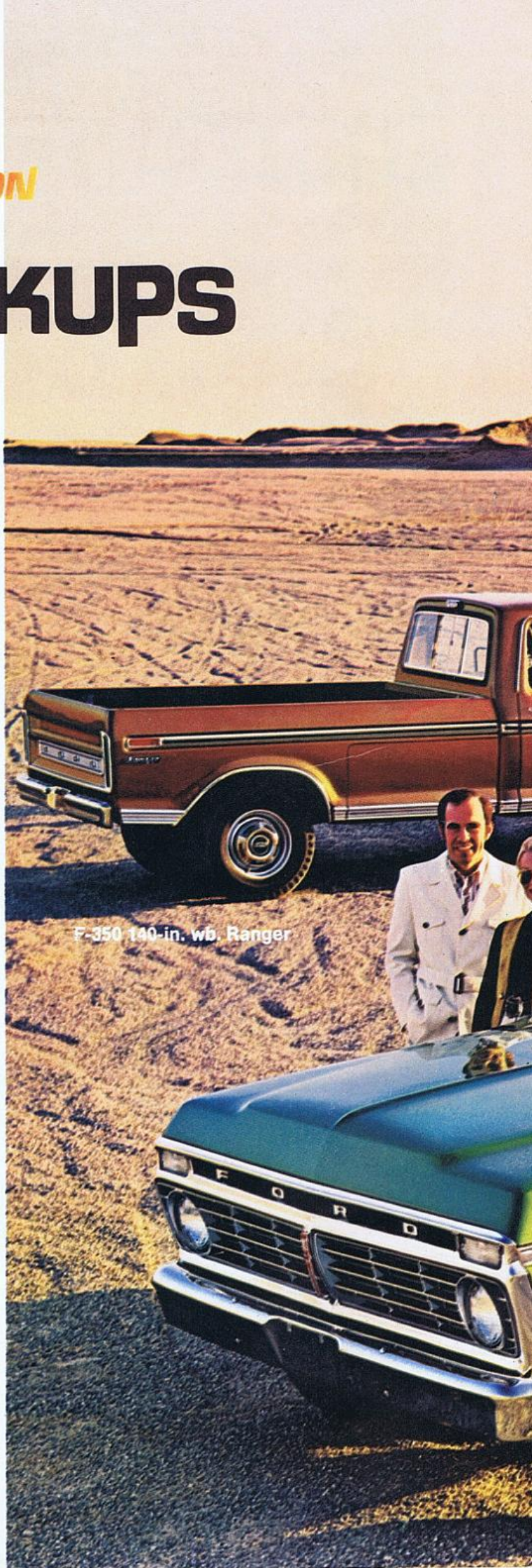

F-350 140-in. wb. Ranger

F-100 Ranger XLT shown with optional wheel covers, whitewall tires and rear bumper. F-350 Ranger Styleside pickup shown with optional sliding rear window, convenience group, low-mount swing-lock mirrors, bodyside molding and rear bumper.



F-100 117-in. wb. Custom 4 x 4

F-100 133-in. wb. Ranger XLT



The Ranger XLT

NEW GENERATION

ROOM & RICHNESS

The handsome "new generation" cab interior is the biggest and roomiest ever offered on a Ford pickup. The gas tank has been moved outside (on most models) to a protected location between the frame rails. You gain seating room and comfort *plus* a big storage space behind the seat. The wide, deep-foam cushioned seat and seat back holds three adults with ease. Ford's attractive upholstery is practical and long wearing. And interiors are color-coordinated with exterior paint. All models feature a bright grille and front bumper, standard!

Custom model cabs feature new deluxe fresh air heater/defroster • energy-absorbing sun visors and instrument panel padding • instrument cluster with

green back-lighting • keyless locking doors • color-keyed molded door panels with integral armrests and paddle-type door handles • seat belts • windshield washers • 2-speed windshield wipers • door courtesy light switches • ash tray • large glove compartment with push-button latch • sponge-grain headlining • black rubber floor mat • door scuff plates • black, red, blue or green vinyl seat trim. Pickups have day/night rearview mirror, LH bright-metal exterior mirror • taillights with integral stop-turn-backup lights and reflector • hub caps (except 4 x 4's) • bright tailgate handle depression (Stylesides).

Ranger model interiors include (in addition to or in place of Custom features) color-keyed pleated cloth seat upholstery with vinyl bolsters • instrument panel molding with black accent • color-keyed door panels



The Ranger



The Custom

with bright moldings • additional insulation • perforated headlining with bright molding • color-keyed vinyl-coated floor mat with heel pads • cigarette lighter. Exteriors feature bright windshield, rear window and roof drip moldings • bright rocker panel and wheel lip moldings • bright hub caps (except 4 x 4's and dual-rear-wheel models). Styleside pickups include aluminum tailgate applique panel • bright tailgate moldings (top and bottom) and taillight bezels.

Ranger XLT models offer (in addition to or in place of Ranger items) color-keyed quilted cloth with vinyl trim seat upholstery • color-keyed pleated vinyl upper door panels with woodtone accented moldings and map pocket lower panels • color-keyed wall-to-wall nylon carpeting • carpeted behind-seat storage area • black steering wheel with woodtone insert • bright instrument panel molding with woodtone accents • bright seat-pivot covers • additional

insulation • convenience group (cargo, engine, glove compartment and ash tray lights, glove compartment lock and 12-in. day/night inside mirror) • color-keyed vinyl headlining and sun visors. Styleside pickup decor includes bright cab and bodyside moldings with vinyl insert • upper tailgate applique panel and molding.

Ranger XLT interior shown with optional air conditioner, SelectShift Cruise-O-Matic transmission and radio. Custom interior shown with optional SelectShift Cruise-O-Matic, radio and convenience group.

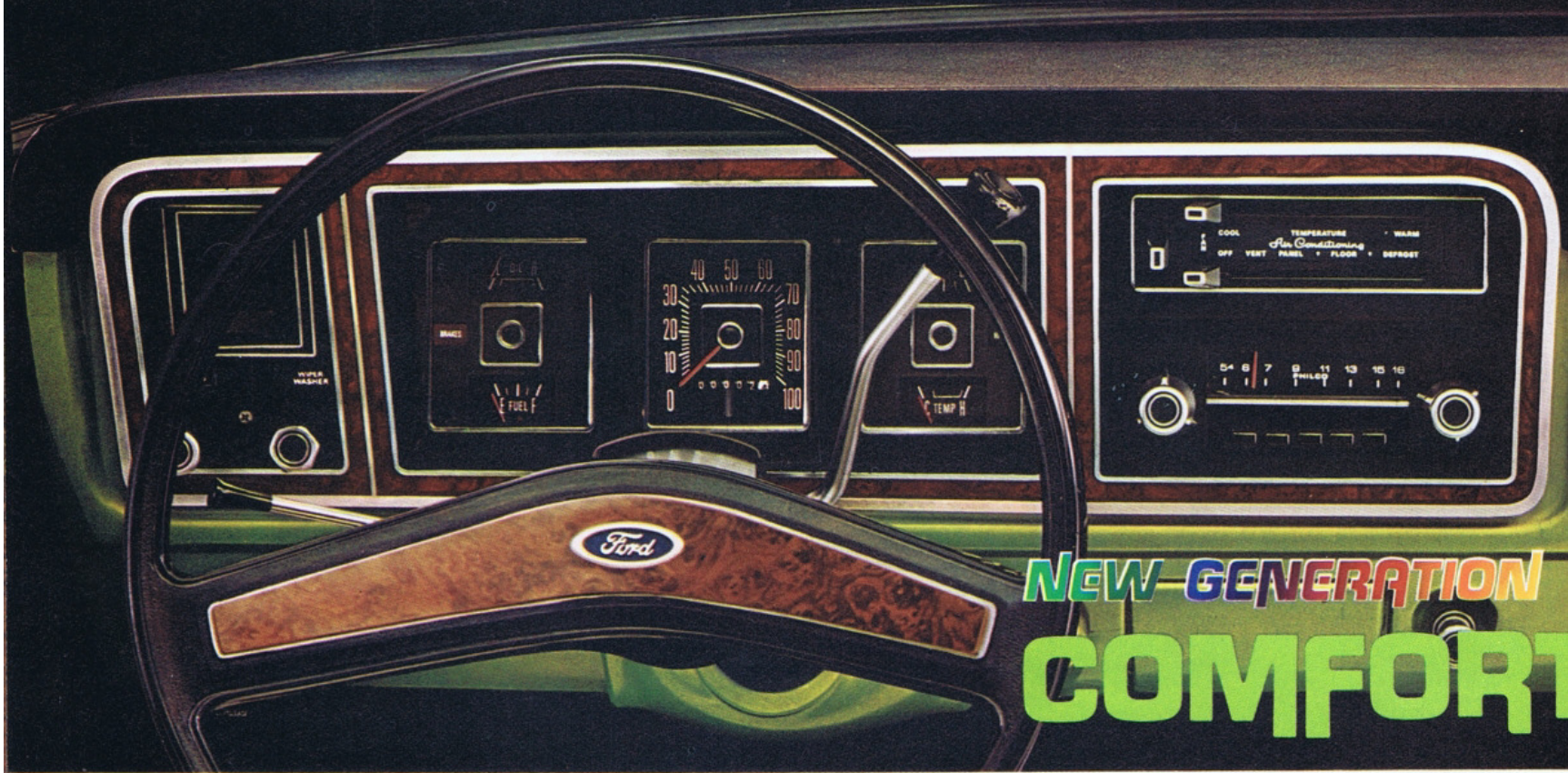

Roomy, inviting new cab interiors look and feel more carlike and comfortable. All the dials and controls in the attractive new instrument panel are fully lighted, easy to see and use. The spacious glove compartment is fully 50% larger than last year's.

The new heater is a modern blend-air type for excellent temperature control and heat output. Optional air conditioning is integrally designed with the heater and hidden behind the instrument panel, leaving lots of stretch-out space.

The Ford new generation cab is even more spacious than last year's roomy cab. There's lots of elbowroom for three husky men. Ford gives you 66 inches of both shoulder room and hiproom.

The high seat position provides comfortable body support and generous legroom . . . and still leaves optimum headroom. Good seat height and increased glass area to the rear and sides allow great all-around visibility. And for a great outlook on rainy days, convenient interval windshield wipers are now optional. For misty rain,



just turn wipers on and relax as the wipers automatically wipe at wide-spaced intervals. For heavy rain, set wipers for faster frequency.

Another new generation better idea is Ford's additional in-cab storage area.

You'll find a large, convenient storage spot behind the seat. Ford moved the gas tank outside, on most models, leaving a handy storage area. This 5½-ft.-wide storage space can hold a variety of things like tool boxes, one-suitcases or golf bags—nicely out of sight within the cab. The seat back unlatches and tilts forward for easy access to this big, in-cab storage area.

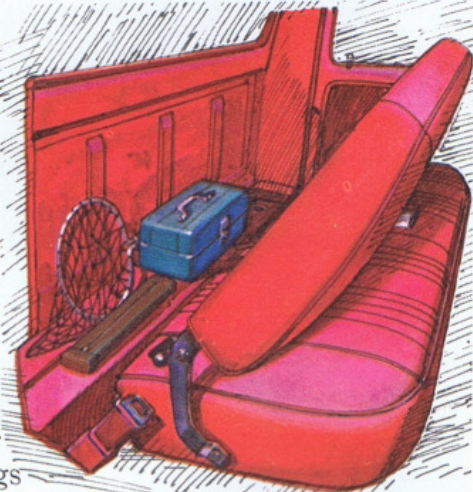

Ford pickups provide you with deep-foam seating comfort! The standard Ford full-width seat in all pickups—Custom, Ranger and Ranger XLT—now has a deep-foam cushion and back for exceptional comfort. The seat is designed to ride soft and dampen out annoying bounce.

The big cab interior allows the new seat back to be angled to the rear so the seat has the proper recline to provide a comfortable driving position for your long



CONVENIENCE

trips. Seat adjusts a big five inches fore or aft to please both short and tall drivers.

Ford Ranger and Ranger XLT seats are upholstered with cloth fabrics that are strong, long-wearing, cool and comfortable.

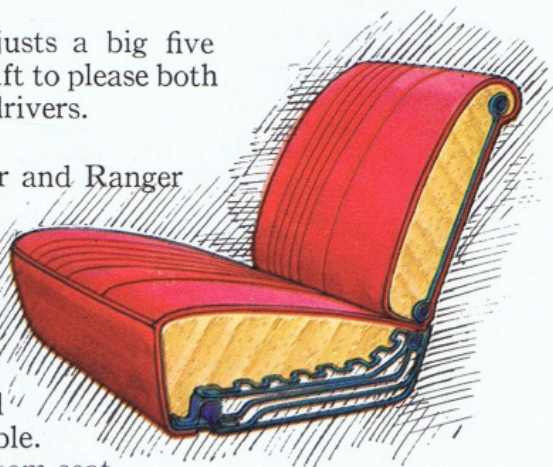

The Ford Custom seat is upholstered in attractive, long-wearing vinyl. Knitted vinyl seat trim that "breathes" for cool comfort and heavy-duty black vinyl seats are optional in all series.

Disc brakes are standard at the front wheels of all Ford F-100 through F-350 4 x 2 models. Ford's disc brakes are durable and self-adjusting. Disc brakes, the concept that stops big jet planes, are designed for straight stops and to dissipate heat.

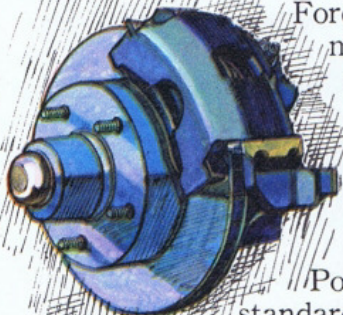

Power disc front brakes are standard on all 4 x 2 pickups with GVW's over 5000 pounds, and optional on the other F-100 4 x 2's.

Ford's low brake-pedal height is a big convenience in stop-start traffic. Ford F-100 pickups with optional power brakes provide a low brake pedal height so you can reach the brake pedal fast for quick stops. Heel-toe operation from the accelerator to the low, suspended brake pedal is possible in traffic.

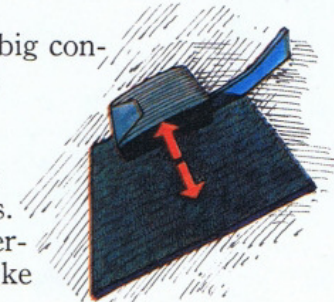

Ford six-man crew cab models are available as a complete factory engineered and installed package on Ford F-250 (4 x 2 and 4 x 4), F-350 and F-600 Series. Two comfortable full-width seats accommodate six husky men with ease. Four large, wide-opening doors allow quick and convenient entry and exit. Ford

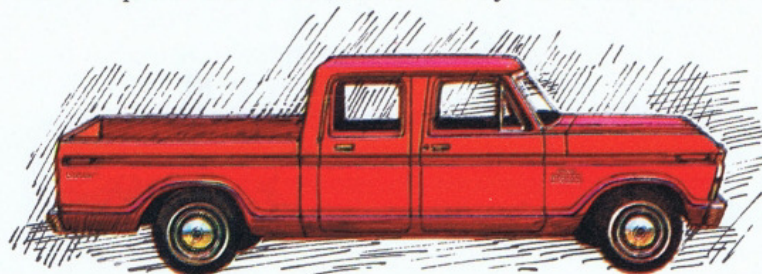

crew cabs are offered with 6¾-ft. Stylesides and 8-ft. Styleside or Flareside pickups, or as chassis-cabs for custom bodies. Big Ford crew cabs provide an excellent combination of carlike roominess and comfort with truckload capacity.

Ranger XLT instrument panel shown with optional air conditioner, SelectShift Cruise-O-Matic and push-button radio.



BEST OF THE PRESENT PLUS **NEW GENERATION** **RUGGEDNESS**

b) **Famous Twin-I-Beam independent front suspension** remains an exclusive Ford feature for both ruggedness and ride. In this unique Ford suspension system, each front wheel has its own forged I-beam axle with big coil spring. Each wheel steps over bumps independently to cushion the ride. Twin-I-Beam suspension also contributes to good cornering. Maintenance requirements are less because this simple, sturdy suspension has caster and camber angles built in structurally and maintained by forged-steel I-beams. You get a smooth ride and superb handling—plus the strength and durability of two forged I-beam axles. It's the number one reason why a Ford pickup can work like a truck, ride like a car.

Complementing the suspension system, Ford's new long-wheelbase design makes for an even smoother pickup ride. The wheelbase for Ford's most popular Styleside body is now 133 inches long. A long wheelbase acts to space out the bumps and give the suspension system a better opportunity to absorb and dampen shocks . . . smooth out the ride. The new F-350 Super Camper Special and F-350 Styleside pickups both feature an 8-ft. box on 140-in. wheelbase. Their long wheelbase with

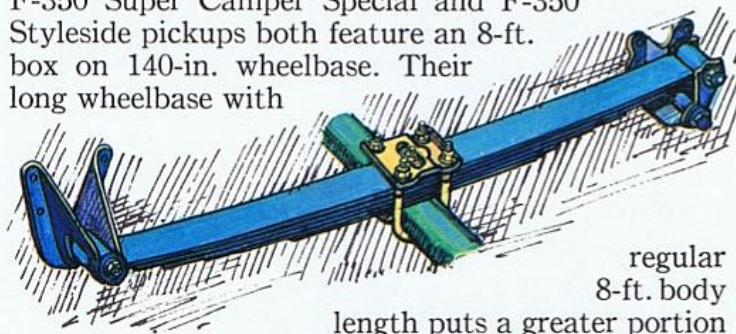

regular 8-ft. body length puts a greater portion of the cargo box ahead of the rear axle, shortens the rear overhang and provides excellent weight distribution with heavy camper bodies.

New F-100 gives you almost a car-type ride in a

tough pickup truck. In addition to the other Ford features already covered, the F-100 pickup has new, long and 2½-inch-wide rear leaf springs for easy going—especially when riding empty or with a light load.

And new soft-riding tires up to L78-15 in size are now available. If your wife never felt comfortable driving a pickup before, just get her to try a 1973 Ford!

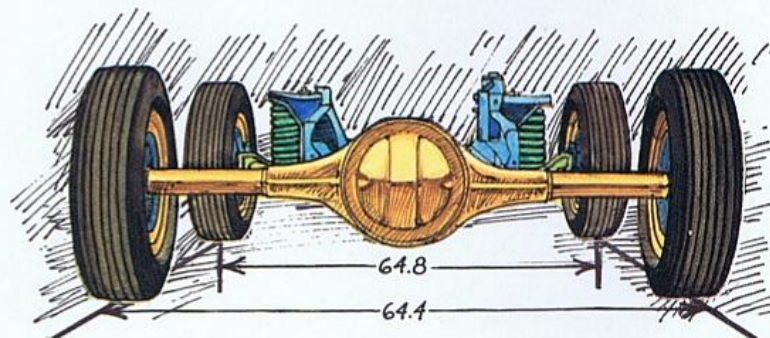

New wide-track stability gives Ford pickups a steady stance and excellent road-holding ability. Tread width on F-100 and F-250's now measures over 64 inches front and rear for even wheel tracking. While F-100 4 x 2 rear tread widths have been increased up to 4 inches and rear leaf springs have been moved wider apart for improved road stability. New front and rear stabilizer bars are now included in Camper Special package and are standard on the new Super Camper Special for even greater resistance to side sway.

While new Ford pickups provide carlike comfort and driving ease, they're all tough truck through and through. **The sturdy new F-100 and F-250 frames** are

AND RIDE

wider than before in back of the cab to provide a strong, stable foundation for the big Styleside pickup box. On most models, the fuel tank is mounted within the protection of husky frame siderails under the rear of the pickup bed just above the spare tire.

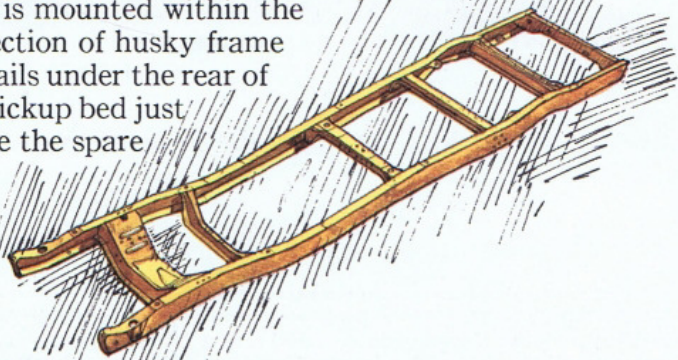

The Styleside body itself is built strong to last long. Double-sidewall strength is only the beginning. Ford's new design utilizes a single strong sheet of steel to form each outer wall. This construction eliminates the complex joining of the three separate pieces that it replaced, thereby reducing possible rust-prone joints. The inner sidewall (on both sides) and the outer panel are galvanized. In fact, over 200 sq. ft. of galvanizing is used throughout Styleside pickups to further guard against corrosion.

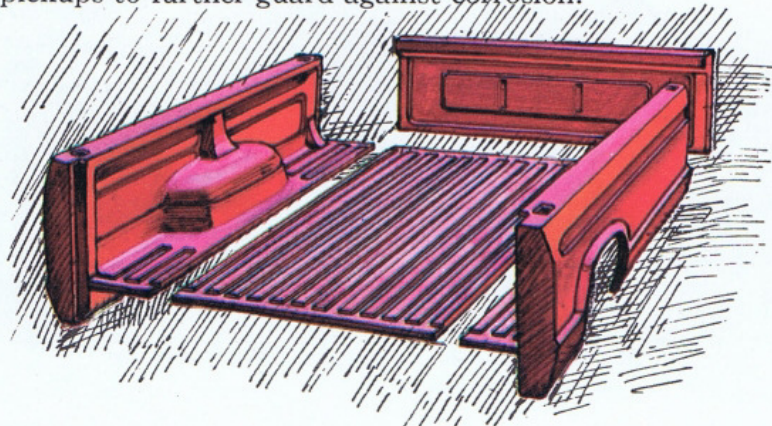

The new Ford cargo box is easy to clean, too. The pickup bed's curved wall-to-floor transition eliminates sharp, dirt-catching corners. You can quickly sweep or hose out the cargo box. The big 50.8-in. width between wheel-housings provides easy clearance for carrying plywood or paneling flat.

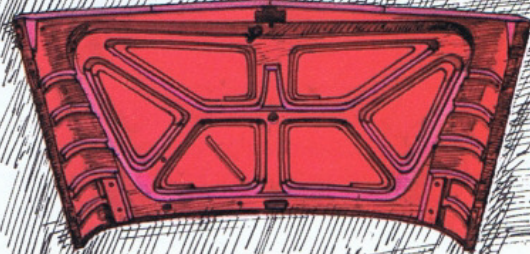

The massive Ford hood has double-wall sections and bridgelike construction for both strength and stiffness. The inner and outer panels are welded into a single rigid hood unit that minimizes vibration or flutter. Sturdy galvanized front fender aprons and double-wall door construction are other examples of Ford's strong, durable construction.

Easy-latching, double-wall tailgate with hinged steel straps has optimum strength. The Ford Styleside pickup tailgate shuts tight on a complete all-steel body built to stay quiet and tight.



Ford F-350 dual-rear-tire chassis-cabs combine big capacity with Twin-I-Beam riding smoothness. F-350's offer a maximum GVW rating of 10,000 lb., and long 137- and 161-in. wheelbases (60- and 84-in. CA's) for 9- to 12-ft. bodies. Chassis-cowl models, 8-ft. Styleside pickups and Super Camper Specials are available.

NEW GENERATION CAPACITY

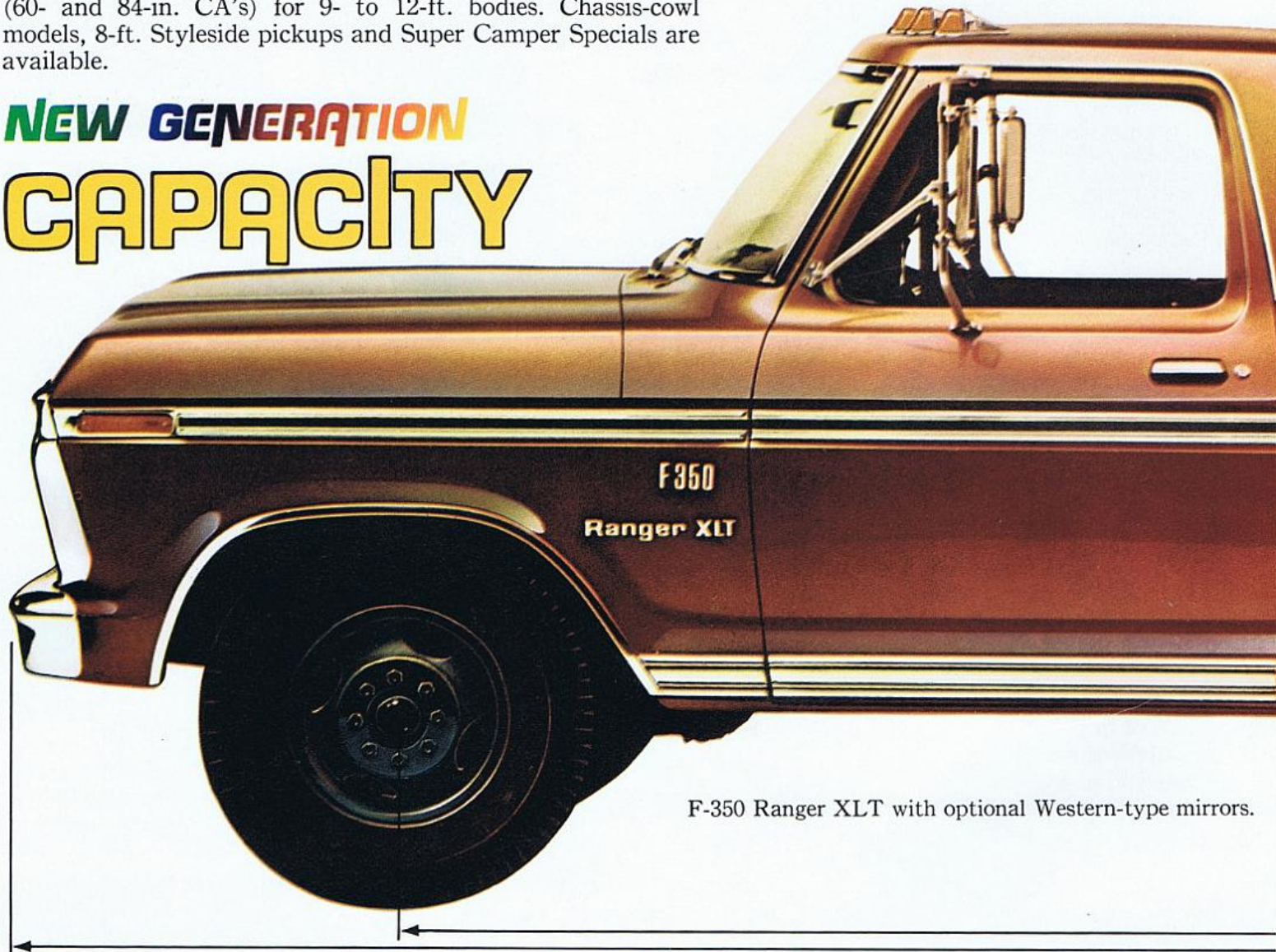

F-350 Ranger XLT with optional Western-type mirrors.

Ford light-duty trucks are offered with a broad range of payload capacities so you can get the right truck for your job. The chart below shows how to find the pickup you need. First, select your desired pickup box style and size (described at upper right) and then move to the next column for your needed payload. Next is the truck series (F-100, 250 or 350)

and the GVW package rating with the components included with each rating. The chart is only a general guide. The specification section on the back cover shows many of the additional heavy-duty components to be considered.

Your Ford dealer will be happy to talk over your intended truck usage and make a careful recommendation for you.

A GUIDE TO PICKUP PAYLOADS • GVW PACKAGE SELECTOR

Pickup Box length	Desired payload including driver and passengers	Model	GVW Package Rating	Equipment included with GVW Rating			
				Front Axle	Front Springs	Rear Springs	Tires
6¾ ft.	940 lb.	F-100	4550 lb. (std.)	2750 lb.	2500 lb.	2450 lb.	G78-15B
	1040 lb.	F-100	4800 lb.	2750 lb.	2500 lb.	2950 lb.	G78-15B
	1380 lb.	F-100	5000 lb.	3000 lb.	2500 lb.	2950 lb.	G78-15B
8 ft.	1760 lb.	F-100	5450 lb.†	3000 lb.	2500 lb.	3300 lb.	G78-15D
	945 lb.	F-100	4650 lb. (std.)	2750 lb.	2500 lb.	2450 lb.	G78-15B
	945 lb.	F-100	4800 lb.	2750 lb.	2680 lb.	2950 lb.	G78-15B
	1285 lb.	F-100	5000 lb.	3000 lb.	2500 lb.	2950 lb.	G78-15B
	1725 lb.	F-100	5500 lb.†	3000 lb.	2500 lb.	3300 lb.	H78-15B
	2260 lb.	F-250	6200 lb. (std.)	3000 lb.	2730 lb.	3830 lb.	8.00 x 16.5D
8 ft.	2915 lb.	F-250	6900 lb.*	3150 lb.	2730 lb.	4450 lb.	8.00 x 16.5E
	3440 lb.	F-250	7500 lb.*	3500 lb.	2900 lb.	5480 lb.	8.75 x 16.5E
	3665 lb.	F-250	8100 lb.*	3500 lb.	3170 lb.	5480 lb.	8.75 x 16.5E
	3815 lb.	F-350	8350 lb. (std.)	3800 lb.	3450 lb.	5450 lb.	8.75 x 16.5E
	4328 lb.	F-350	9000 lb.	3800 lb.	3450 lb.	5900 lb.	12.00 x 16.5E*
	4720 lb.	F-350	9500 lb.	3800 lb.	3450 lb.	6310 lb.	9.50 x 16.5E*
	5080 lb.	F-350	10,000 lb.	3800 lb.	3450 lb.	6960 lb.	12.00 x 16.5E*
Body length 9 ft.	6030 lb.††	F-350	10,000 lb. (max.)	3800 lb.	3450 lb.	7250 lb. and 1100 lb. Aux.	8.00 x 16.5D front 8.00 x 16.5E dual rear
12 ft.	5860 lb.††	F-350	10,000 lb. (max.)	3800 lb.	3450 lb.		

†Power brakes included. *12" x 2½" HD brakes included. ††Body and payload allowances available on Ford F-350 dual rear-wheel models with a maximum GVW of 10,000 pounds.
‡Computer selected—minimum rating. *Rear tires only, front tires are 9.50 x 16.5 D.

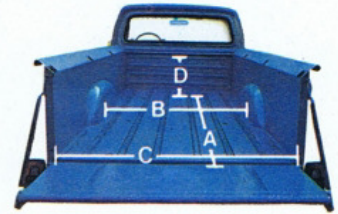
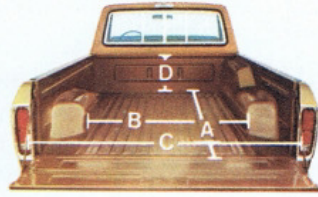
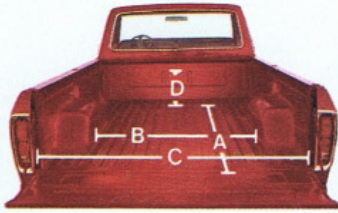

Styleside pickups, available in 6¾- and 8-ft. lengths, have strong double-sidewall construction. Each inner and outer panel is one solid piece. Fewer joints and over 200 sq. ft. of galvanizing throughout all Styleside pickups protect against rust and corrosion. Strong double-wall tailgate.

F-350 8-ft. Styleside pickup and Super Camper Special (140-in. wb.) have the spare-tire location built into the outer right side of this Styleside box. Wheel housings are located closer to the rear of the box, and the rear-axle-to-tailgate dimension is only 39.2 inches for better balance with big campers or special equipment.

Platform/Stakes in 9- & 12-ft. lengths are designed for big loads. Floor frames are formed of steel cross sills riveted to steel siderails. Floorboards are interlocked with steel skid strips and corners are reinforced with steel brackets. Formed steel caps cover ends of body sills. Side boards are hardwood and stakes are steel.

Flareside pickups (8-ft., 133-in. wb.) have running boards between cab and fenders for easy side loading and seasoned hardwood floorboards with interlocking steel skid strips. Rubber-covered forged-steel chains support tailgate when open, toggle-type latches maintain tight seal when tailgate is closed.

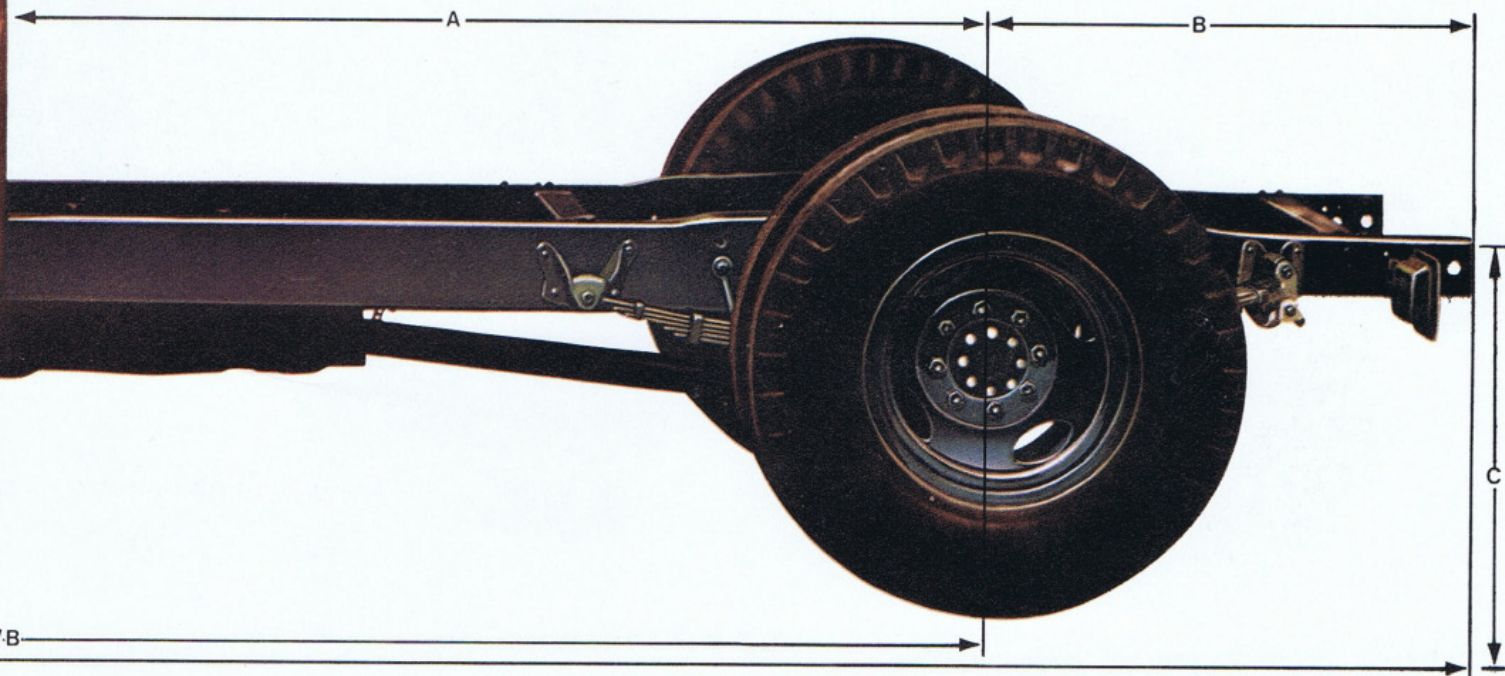

BODY AVAILABILITY AND CARGO AREA DIMENSIONS							
SERIES	Wheel-base (in.)	Nominal Cargo Box Length (ft.)	Inside Length (in.) (A)	Width Between Wheel-housings (in.) (B)	Tailgate Opening (in.) (C)	Inside Depth at Sides (in.) (D)	Cargo Cap'y (cu. ft.)
STYLESIDE PICKUPS							
F-100	117	6¾	82.0	50.8	65.0	19.3	60.5*
	133	8	98.2	50.8	65.0	19.3	73.1*
F-250	133	8	98.2	50.8	65.0	19.3	73.1*
F-350	140	8	98.2	49.0	65.0	19.3	65.1*
Super Camper	140	8	98.2	49.0	65.0	19.3	65.1*
FLARESIDE PICKUPS							
F-100	133	8	96.0	48.4	54.0	22.0	65.4*
F-250	133	8	96.0	48.4	54.0	22.0	65.4*
STAKE OR PLATFORM							
F-350	137	9	106.0†	—	82.1‡	31.2	—
			109.4‡		87.3‡		
	161	12	142.0†	—	82.1‡	42.0	—
			145.4‡		87.3‡		

*Allowance made for wheelhousings. †Stake. ‡Platform.

Chassis-cab models are offered for mounting van and other special-purpose bodies. Frame rails are straight and parallel behind cab, except for a slight kickup over the rear axle, for easy body installation and low loading heights. Chassis-cowl models are also offered on F-350 Series.

CHASSIS-CAB DIMENSIONS (in.)				
	F-100	F-250	F-350	
Wheelbase (WB)	117	133	133	137 161
Back of cab to rear axle (A)	40	56	56	60 84
Rear axle to end of frame (B)	40.6	40.6	40.6	38.5 47.5
Frame to ground ht.—empty (C)	24.8	24.8	26.8	27.0 27.0
Overall length (D)	189.1	205.3	205.3	207.0 240.0

All-new Ford F-350 Super Camper Special 8-ft. pickups have a 140-in. wheelbase—the longest ever offered in a Ford pickup! The result is good weight distribution for this pickup's 8350- to 10,000-lb. GVW, and better handling with big slide-in campers up to 12 ft. long.

NEW GENERATION FUN FLEET

The new Ford Super Camper Special attains its optional 10,000-lb. GVW with single rear tires. The big "Super Singles" (12.00 x 16.5 tires)* provide exceptional stability.

Ford's bodyside spare tire mount (see illustration on page 14) puts your optional spare within the right side of the pickup box wall ahead of the rear axle.

Another better idea from Ford, the camper specialist. This F-350 includes—as standard—all the features in the Camper Special package listed in the chart at right. In addition, the F-350 Super Camper Special includes: 360 V-8 engine and SelectShift Cruise-O-Matic transmission. A big 460-cu. in. V-8 engine is optional* for outstanding performance with heavy camper loads.

Ford offers Camper Special packages (this complete package is already standard on Super Camper Special) for F-250 pickups and F-250, F-350 chassis-cabs.

F-250 Camper Special provides a maximum GVW of 8100 lb., and is designed to carry 11-ft. slide-in or chassis-mounted campers.

F-350 Camper Special chassis-cabs are available with 137-in. wheelbase for up to 12-ft. campers. The long



F-350 Ranger XLT Super Camper Special

161-in. wheelbase F-350 with dual rear wheels has a GVW rating up to 10,000 lb. for chassis-mounted, cab-over camper bodies up to 14 ft. long.

A new Ford fiberglass pickup box cover is available. This custom-designed pickup box cover comes in two trim levels—standard and deluxe. Both look slim and streamlined, but are five inches higher than cab for ample headroom. Locking rear liftgate and tinted glass in side and rear windows are standard on regular box cover.

Deluxe pickup box cover has (in addition to or in place of regular box cover): Sliding side windows with screens • bright side and rear window moldings • roof vent • dome light • two-tone paint.

Many other camper options are available (including Ford's new 460 V-8*, frame-anchored camper tie-down system and dual batteries) for your complete camping enjoyment. See next pages.

*Available February 1973

**F-250/350 CAMPER SPECIAL PACKAGE (Pickups & Chassis-Cabs)
(STANDARD ON F-350 SUPER CAMPER SPECIAL)**

Camper Special Package Includes:

- 55-amp. alternator
- 70 amp-hr battery
- Oil pressure gauge
- Bright 6" x 10" western long arm mirrors
- Ammeter
- Front and rear stabilizer bars
- HD transmission oil cooler (with Cruise-O-Matic)
- Extra cooling package
- Camper wiring harness*
- Dual electric horns
- Rear shock absorbers (350)
- "Camper Special" emblem

*Includes 12-volt 7-wire (identified) sealed cable with connectors for camper body lighting.

MINIMUM OPTIONAL EQUIPMENT REQUIRED

This chart shows GVW and minimum equipment required for Camper Special Package. Equipment shown does not necessarily represent maximum equipment obtainable and in many cases additional optional equipment is available for maximum camper loads. For example, a super cooling package is recommended on the F-250 for extended operation in hot climates. And for optimum handling and stability with full-size campers 9.50 x 16.5 D or E tires are recommended (8.75 x 16.5 E minimum) in single rear wheel units.

GVW (lb.)	F-250		F-350 (SR)	F-350 (DR)	
	6900	7500, 8100	8000	9000	10,000
Engine	V-8		V-8	V-8	V-8
Transmission	4-Spd. or Cruise-O-Matic				
Tires: Front	8.75x16.5 E				
‡Rear	8.75x16.5 E				
Tube type	or				
Front	7.50x16 D	7.50x16 E	7.50x16 C	7.50x16 C	7.50x16 C
Rear	7.50x16 D	7.50x16 E	7.50x16 E	7.50x16 C	7.50x16 C
Maximum Camper Length	11 ft. w/133" wb.		11 ft. w/137" wb. 12 ft. w/161" wb.	12 ft. w/137" wb. 14 ft. w/161" wb.	

‡If spare tire is ordered, rear tire size should be selected.
*See "minimum optional equipment required" note above.

(SR) = Single rear wheels.
(DR) = Dual rear wheels.



F-250 Ranger Camper Special



F-100 Ranger XLT with optional Ford deluxe box cover, wheel covers, whitewall tires and rear bumper



NEW GENERATION

OPTIONAL GEAR

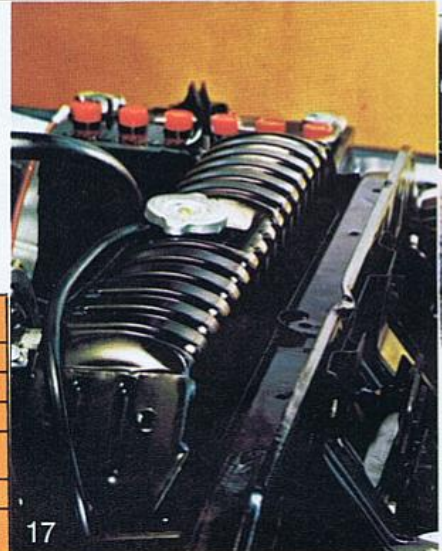
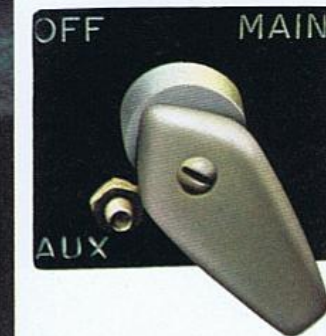
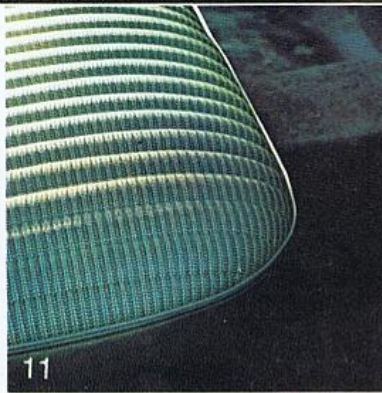
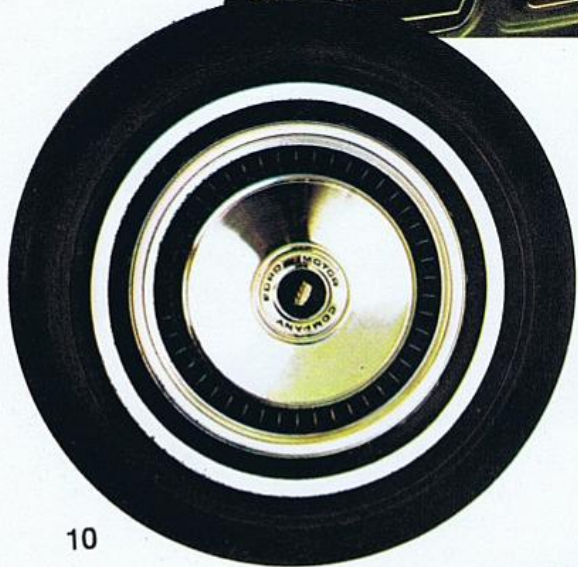

ENGINE SPECIFICATIONS

	Displacement	Bore and Stroke (in.)
Std. F-100	240 cu. in.	4.0 x 3.19
Std. F-250, F-350	300 cu. in.	4.0 x 3.98
Opt. F-100 4 x 2	302 cu. in.	4.0 x 3.0
Std. F-350 Styleside and SCS, Opt. all others	360 cu. in.	4.05 x 3.50
Opt. All 4 x 2's	390 cu. in.	4.05 x 3.78
Opt.* F-250 and F-350 4 x 2's	460 cu. in.	4.36 x 3.85

*Available February 1973

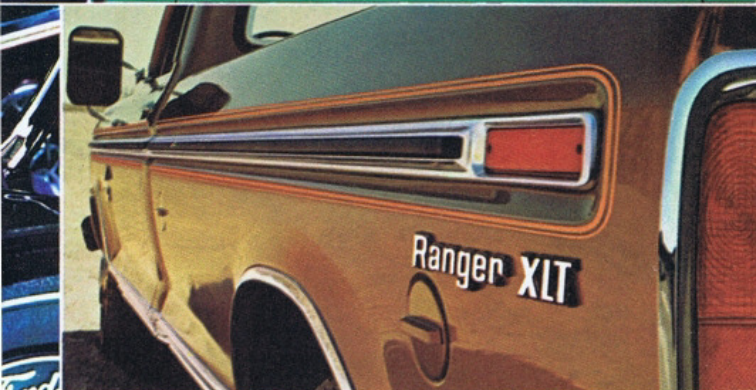

1. Rear step bumper for 8-ft. Styleside pickups is reinforced with center plate and is drilled for a ball hitch. **2. Western-type mirrors** are offered with long arms or new low-mount swing-lock. **3. Pickup box cover** for 8-ft. Stylesides has strong, lightweight fiberglass construction, tinted side and rear windows, T-handle liftgate latch with lock. **Deluxe model** (shown) has sliding side windows with screens, bright side and rear window moldings, roof vent, dome light, two-tone paint color-keyed to the most popular truck colors. **4. Sliding rear cab window** has outer molding to accept a weatherseal boot between cab and camper. **5. Concealed spare tire and wheel** in the right side of the F-350 Super Camper Special and Styleside pickup box. Outer panel opens easily for convenient access to the spare. **6. Auxiliary 12-volt 70 amp-hr battery** with dual circuit charging system. **7. Air conditioner** is smart looking integral unit with heater for year-round comfort. Air conditioner option includes 55-amp. alternator, 70 amp-hr battery and extra cooling package. **8. AM/FM stereo radio** with speaker in each door, or AM radio. **9. Black-texture painted roof** includes bright drip rail molding (if not standard) and bright back of cab molding. **10. Full wheel covers** (for 4 x 2's and F-100 4 x 4) now even with 16½-in. wheels or mag-style covers for 15-in. wheels. **11. Breathable knitted vinyl seat trim** or **heavy-duty black vinyl trim**. **12. 22.5-gal. auxiliary fuel tank** (20.2 gal. F-100). **13. SelectShift Cruise-O-Matic** gives both fully automatic or manual shifting. **14. Bright-metal bodyside molding with vinyl insert** (standard Ranger XLT) or narrow bright-metal bodyside molding. **Dual tape stripes** (shown) extending the full length of Stylesides are available in five paint-keyed colors. **15. Bright tie-down hooks**. Eight convenient cargo tie-down hooks for Stylesides. **16. Optional V-8 engines**. **17. Super cooling package**. Increased capacity radiator (also includes HD transmission oil cooler when Cruise-O-Matic is ordered) is optional with 360, 390 and 460 V-8's for extra performance in hot climates. Excellent for pickups equipped with campers, or pulling trailers. **18. Slide-out spare tire carrier**. This carrier has a sliding mechanism so spare tire can easily be pulled from its under-frame location. Tire slides out and down to the ground at rear of pickup for easy access. Spare tire carrier can be padlocked. **19. Tool storage box** with locking door for easy-to-reach storage. Located in curbside of pickup box skirt on 8-ft. (133-in. wb.) Stylesides.

Other popular options include: Convenience group (standard on XLT) with cargo, engine, glove compartment and ash tray lights; glove compartment door lock, door map pockets and 12-in. day/night inside mirror • Northland Special package with engine block heater, 50% (-35°F) antifreeze, 70 amp-hr battery, 55-amp. alternator and limited-slip rear axle • Power front disc brakes (4 x 2's) • Power steering • High-output heater • Dual electric horns • Trailer towing packages (up to 10,000 lb.) • Ammeter and oil pressure gauge • Bright hub caps • Bright contour rear bumper for Stylesides • Painted channel rear bumper for Flaresides • Tinted glass all around • Shoulder harness • Oil-bath engine air cleaner • Frame-anchored camper tie-down system • Interval windshield wipers.

SPECIFICATIONS-COLORS

Colors and Combinations

Standard Colors: Wimbledon White, Mallard Green, Limestone Green Metallic, Seapine Green Metallic, Winter Green, Candyapple Red, Royal Maroon, Tampico Yellow, Durango Tan, Raven Black, Wind Blue, Bahama Blue, Midnight Blue Metallic, Sequoia Brown Metallic, Chrome Yellow, Pure White. Different two-tones are obtained by using all the standard colors *except* Chrome Yellow and Pure White. Wimbledon White may be used as the accent color for any other color. Consult your Ford Dealer for the other accent color combinations as well as the different ways the Styleside models may be painted. Two-tone applications are as follows:

Pickup box cover in Textured White is available on 8-ft. Styleside pickups.

Deluxe pickup box cover has two-tone treatment with Textured White incorporating Styleside body color as an accent with Candyapple Red, Bahama Blue, Limestone Green Metallic, and Sequoia Brown Metallic. Textured White with Wimbledon White accent color is used with all other body colors.

Regular: The accent color is applied to the roof and upper back panel with a belt line molding from door to door around back of cab.

Deluxe (Styleside pickups only): The accent color is applied to the area below the body-side and lower tailgate moldings which are included in this option.

Combination (Styleside pickups only): Regular and Deluxe two-tone options are combined with the accent color applied as specified above for these two options.

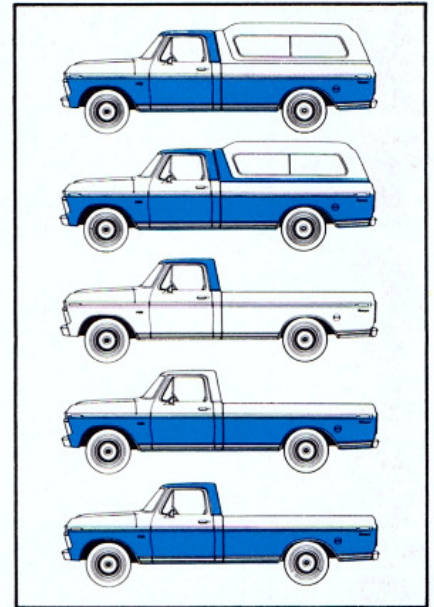

EQUIPMENT	TWO-WHEEL DRIVE				FOUR-WHEEL DRIVE	
	F-100	F-250	F-350	F-350 Styleside	F-100 (4 x 4)	F-250 (4 x 4)
Maximum GVW	5500 lb.	8100 lb.	10,000 lb.*	9500 lb.	5600 lb.	7700 lb.
Axle, Front: Type	Twin-I-Beam	Twin-I-Beam	Twin-I-Beam	Twin-I-Beam	Full-floating, Drive	Full-floating, Drive
Rating	2750 lb.	3000 lb.	3800 lb.	3800 lb.	3300 lb.	3300 lb.
Optional Rating	3000 lb.	3500 lb.	—	—	—	3550 lb.
Axle, Rear: Capacity	3300 lb.	5300 lb.	7400 lb.	7400 lb.	3300 lb.	5300 lb.
Ratios (to 1)**	3.70, 3.00, 3.25, 3.50	4.10, 3.54, 3.73	4.56, 3.73, 4.10	4.10, 3.73, 4.56	3.70, 3.50, 4.11	4.10
Limited-Slip Diff. Rating	3300 or 3600 lb.	5300 lb.	7400 lb.	7400 lb.	3600 lb.	5300 lb.
Ratios (to 1)**	3300—3.70 3600—3.50	3.54, 3.73, 4.10	4.10	4.10	3.50, 4.11	4.10
Brakes, Service: Front	Front Disc	Front Disc	HD Disc	HD Disc	11" x 2"	12½" x 2"
Rear	11½" x 2¼"	12½" x 2"	12" x 3"	12" x 3"	11½" x 2¼"	12" x 2½"
Power (Vacuum Booster)	10.0" dia. Opt.	10.0" dia. Std.	11.2" dia. Std.	11.2" dia. Std.	7.9" dia. Opt.	7.9" dia. Opt.
Optional Brake Size	—	HD [†]	—	—	—	—
Clutch: Dia. (in.)—Area (sq. in.)	11—123.7§	11—123.7§	11—123.7§	11—123.7	11—123.7	11—123.7
Electrical: 12-Volt Battery	54 plates—45 amp-hr	54 plates—45 amp-hr	54 plates—45 amp-hr	54 plates—45 amp-hr	54 plates—45 amp-hr	54 plates—45 amp-hr
Optional Battery‡	66 plates—70 amp-hr	66 plates—70 amp-hr	66 plates—70 amp-hr	66 plates—70 amp-hr	66 plates—70 amp-hr	66 plates—70 amp-hr
Std. Alternator	38 amp., 570 watt	38 amp., 570 watt	42 amp., 630 watt	42 amp., 630 watt	38 amp., 570 watt	38 amp., 570 watt
Opt. Alternator	42 or 55 amp.	42 or 55 amp.	55 amp.	55 amp.	42 or 55 amp.	42 or 55 amp.
Engine: Displacement	240 Six	300 Six	300 Six	360 V-8	240 Six	300 Six
Optional	302 V-8, 360 V-8, 390 V-8	360 V-8, 390 V-8, 460 V-8†	360 V-8, 390 V-8, 460 V-8†	390 V-8, 460 V-8†	360 V-8	360 V-8
Frame: Section Modulus (Short wb.)	3.09	4.14	5.58	6.63	3.92	5.58
(Long wb.)	3.26	—	7.84	—	4.14	—
Shock Absorbers: (Double-acting)	Front & Rear	Front & Rear	Front	Front & Rear	Front & Rear	Front & Rear
Optional	HD Front & Rear	HD Front & Rear	Rear, HD Front	—	HD Front & Rear	HD Front & Rear
Springs, Front: Computer Selected Min.	1250	1365	1725	1725	1365	1550
Rating @ grd. (lb.) Max. Opt.	1500	1650	1850	1850	1600	1775
Springs, Rear: Rating @ grd. (lb.)	1225	1915	2025	2725	1475	1975
Optional Main	1475, 1650	2225, 2740	2725, 3525, 3625	3155	1875	2700
Optional Auxiliary	410	700	550, 900	—	—	550
Steering: Type	Recirculating Ball	Recirculating Ball	Recirculating Ball	Recirculating Ball	Worm & Roller	Worm & Roller
Optional	Integral Power	Integral Power	Integral Power	Integral Power	Linkage Power	Linkage Power
Transfer Case: Type	—	—	—	—	1-Speed [■]	2-Speed
Transmission: Type	3-Speed Synchronized	3-Speed Synchronized	4-Speed	4-Speed	4-Speed	4-Speed
Optional	4-Speed & Cruise-O-Matic	4-Speed & Cruise-O-Matic	Cruise-O-Matic	Cruise-O-Matic	Cruise-O-Matic	Cruise-O-Matic
Wheels: Type—Rim Size (Standard)	(5) 5-hole—5.5K	(4) 8-hole—6.0	(4) 8-hole—6.0	(4) 8-hole—6.75	(5) 5-hole—5.5K	(4) 8-hole—6.0
Tires: Tubeless	G78-15 B PT	8.00 x 16.5 D	8.00 x 16.5 D	8.75 x 16.5 E	G78-15 B PT	8.00 x 16.5 D
Optional	Both tubeless and tube-type in sizes to match GVW requirements					

*8000 lb. w/single rear tires. †Includes HD disc front, 12" x 2½" rear brakes and 11.2" booster. §11½" dia. clutch, incl. w/390 V-8. ■2-Speed w/Cruise-O-Matic. ‡Aux. battery with dual circuit charging system available. **See your Ford Dealer for availability. PT=passenger type. Use adequate tires for loads and type of service. Consult your Ford Dealer. †Available February 1973

Specifications, descriptions and illustrative material contained herein were as accurate as known at the time this publication was approved for printing. Ford Division reserves the right to discontinue models or options at any time or change specifications, equipment or design without notice and without incurring obligation. Specifications, equipment are applicable to units sold in the United States, its territories and possessions and may vary outside these areas. Some of the vehicle colors and paint combinations illustrated are special order options only. Truck body installations and modifications are the responsibility of the body manufacturer. Owners should assure themselves of the load and handling capabilities of their vehicle when selecting a camper or contemplating custom add-ons and modifications. All options and accessories illustrated or referred to as optional or available in this publication are at extra cost. Some options are required in combination with other options. For the price of the model with the equipment you desire or verification of specifications contained herein, see your Ford Dealer.

FORD PICKUPS FORD DIVISION

Availability may be subject to Environmental Protection Agency certification.