

2018

YUKON



REIGN LIKE A PRO

Premium. It's everywhere you look, touch and experience in the 2018 Yukon. EcoTec3 engines offer proven V-8 power plus efficiency, while the suspension is engineered for uncompromising ride and handling. Inside, a quiet, well-appointed cabin welcomes you with premium materials and intuitive technologies. They are reminders that the same passion and purpose that drive you also drive us. We're setting our own standards and proving that Professional Grade isn't merely a label, it's a way of life.



YUKON XL SLT IN WHITE FROST TRICOAT (left)
YUKON DENALI IN IRIDIUM METALLIC (right)
shown with available equipment.

YUKON IN ALL ITS FORMS

Living like a pro means having the right amount of room to fit your life. So, we've designed Yukon and Yukon XL to do just that. Both models offer the option of seating for up to nine. Need extra space? Choose Yukon XL and gain additional cargo room behind the first, second and third rows. Your second- and third-row passengers will also benefit from the comfort of generous leg room. Yukon is available in Denali, SLT and SLE trim levels so you can tailor the amenities to suit your style.



YUKON DENALI IN CRIMSON RED TINTCOAT (left)
YUKON XL DENALI IN IRIDIUM METALLIC (center)
YUKON XL SLT IN WHITE FROST TRICOAT (right)
Vehicles shown with available equipment.



DESIGN

WHEN IT COMES TO DESIGNING THE STANDARD-BEARER OF PREMIUM SUVs, THERE'S A DIFFERENCE BETWEEN STANDING OUT AND STICKING OUT. TASTEFUL CURVES, DIGNIFIED LINES AND ATTENTION TO DETAIL DEFINE YUKON.



DENALI

THIS IS OUR EXCLAMATION POINT

The ultimate expression of Professional Grade arrives in the form of Yukon Denali. Signature Denali styling begins with its new satin-chrome-finished grille, GMC signature C-shaped high-performance projector-beam HID headlamps and continues with available 22" wheels and optional power-retractable assist steps with perimeter lighting.

- + New Distinctive Denali Grille
- + 420-hp 6.2L V-8 With New 10-speed Automatic Transmission
- + Power-Retractable Assist Steps With Perimeter Lighting (Available)

YUKON XL DENALI IN WHITE FROST TRICOAT shown with available equipment.

A HUSH COMES OVER THE CROWD

Yukon Denali welcomes you with quiet. Acoustic laminated windshield and front door glass, triple door seals, an engine compartment barrier and damping materials in the floor sheet metal all help to keep noise from entering the cabin. Yukon Denali adds Bose® Active Noise Cancellation to help tune out additional engine noise. As a result, you'll enjoy the quietest Yukon ever. In Yukon Denali, premium surroundings abound thanks to authentic materials—burnished aluminum trim, new Mastique Ash wood grains and perforated first- and second-row Mulan leather-appointed seating.

+ **Contrasting French Seam Stitching**

+ **New Mastique Ash Wood Grain Interior Accents**

+ **Perforated First- and Second-Row Leather-Appointed Seating and Heated/Ventilated Driver and Front-Passenger Seats**

+ **Head-Up Display**



YUKON DENALI INTERIOR IN COCOA/DARK ATMOSPHERE shown with available equipment.

SLT

SMOOTH. VERY SMOOTH.

Yukon SLT was designed for efficient aerodynamics. Bold, sculpted lines glide from the three-dimensional grille and over the inlaid doors for smooth, uninterrupted airflow. To complete the design, the liftgate spoiler conceals the rear wiper to reduce drag for optimal efficiency.

+ Inlaid Doors Reduce Wind Noise

+ Acoustically Laminated Windshield and Front Door Glass Enhance Quietness

+ SLT Premium Edition Includes All of the Above Plus Uniquely Designed 22" Chrome Wheels and Grille, Bright Chrome Bodyside Moldings and Polished Exhaust Tip



YUKON SLT PREMIUM EDITION IN CRIMSON RED TINTCOAT (left)
YUKON XL SLT IN QUICKSILVER METALLIC (right)
shown with available equipment.

WHISPERS PREMIUM

Premium is measured in many ways. In Yukon SLT, it's all about the abundance of authentic materials and ergonomically designed gauges and controls, as well as seating that keeps you and your passengers comfortable every mile of your journey.

- + Keyless Entry and Push-Button Start
- + Tri-Zone Automatic Climate Controls
- + Power-Adjustable Pedals
- + Front Heated and Ventilated Perforated Leather-Appointed Seating and Second-Row Outboard Heated Seats
- + 12-Way Power Driver and Front-Passenger Seat Adjuster



YUKON SLT INTERIOR IN COCOA/DUNE
shown with available equipment.



ENGINEERING

FROM GENERATING POWER EFFICIENTLY TO SMOOTHING OUT YOUR RIDE,
THE DRIVING FORCE BEHIND YUKON RESULTS IN AN OVERWHELMING FEELING OF CONFIDENCE.



YUKON DENALI IN SATIN STEEL METALLIC shown with available equipment.

HANDLES THE STRAIGHT AND NARROW. AND THE TWISTS AND TURNS.

Behind the wheel of Yukon, you'll feel confident and in command of the renowned EcoTec3 engine technologies while you and your passengers enjoy a comfortable ride. Yukon Denali goes a step further by adding Magnetic Ride Control (illustrated below), a suspension that speed-reads the road up to 1,000 times a second, and responds to give you maximum comfort and control.

Cruising

On smooth roads, the iron particles in the patented magnetorheological fluid align to allow for a smooth ride.

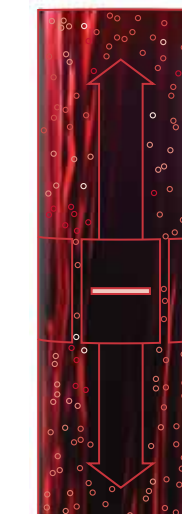

Controlled

During cornering or on uneven surfaces, a magnetic field realigns the particles for a more secure, precise driving experience.

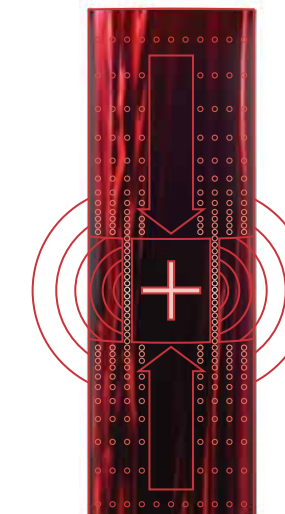

A POSITION OF STRENGTH

From Yukon's fully boxed frame to its EcoTec3 engine family, it is engineered to put you in a constant position of strength, power and efficiency.

EcoTec3 Engines They use Direct Injection (DI), Active Fuel Management (AFM) and continuously Variable Valve Timing (VVT) to deliver exceptional power, efficiency and durability. At 23 mpg highway, the 5.3L engine offers the best V-8 highway fuel efficiency¹ in a full-size SUV. For more performance, Yukon Denali's 6.2L engine offers class-leading V-8 power, producing 420 hp and 460 lb-ft of torque.

Active Aero Grille Shutters Grille shutters automatically close to maximize aerodynamic efficiency when conditions are right. The shutters are designed to remain open in situations where maximum airflow is needed.

Transmissions The 5.3L V-8 features a 6-speed and the 6.2L V-8 is paired with a 10-speed automatic transmission. They both offer the control of a manual and the ease of an automatic with Driver Shift Control.

Magnetic Ride Control On Yukon Denali, it senses changes in the road up to 1,000 times a second, instantly adjusting each shock absorber for maximum comfort, control and agility.

Corrosion-Resistant Duralife Brake Rotors GMC engineers used patented Ferritic Nitro-Carburizing (FNC) technology that can help double rotor life.

Four-Wheel Drive Yukon's available four-wheel-drive system allows you to switch between two-wheel drive for optimum fuel efficiency¹ and four-wheel drive for additional traction and control.

Four-Wheel Disc Brakes The stopping system improves pedal feel for a stronger, more confident braking performance.

Fully Boxed Frame Yukon's frame is constructed with 75 percent high-strength steel for maximum people- and cargo-carrying capability.

Electric Variable-Assist Power Steering The electric variable-assist power rack-and-pinion steering system improves fuel efficiency¹ versus engine-powered systems.

Shear-Style Body Mounts Connecting the body to the frame are high lateral-rate and hydraulic body mounts. They provide additional comfort and a smoother, quieter ride.

¹EPA-estimated mpg: 16 city/23 hwy [2WD], 16 city/22 hwy [4WD], 15 city/22 hwy [XL 4WD] with 5.3L V-8 engine and 14 city/23 hwy [2WD], 14 city/22 hwy [4WD], 14 city/21 hwy [XL 4WD] with 6.2L V-8 engine. Based on GM Large SUV segment.

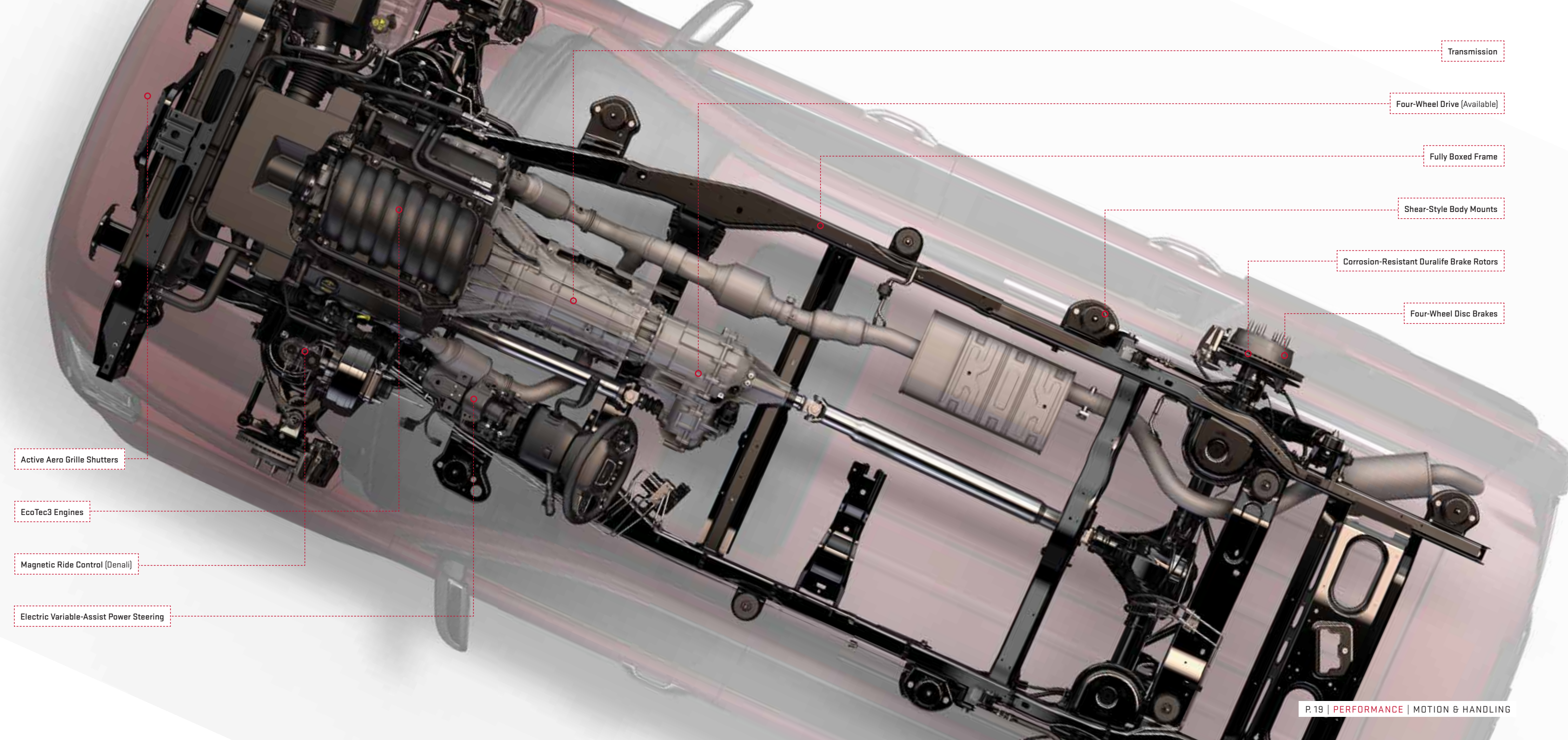

Transmission

Four-Wheel Drive (Available)

Fully Boxed Frame

Shear-Style Body Mounts

Corrosion-Resistant Duralife Brake Rotors

Four-Wheel Disc Brakes

Active Aero Grille Shutters

EcoTec3 Engines

Magnetic Ride Control (Denali)

Electric Variable-Assist Power Steering

SOME HOBBIES REQUIRE BIGGER EQUIPMENT

Everything about Yukon is designed and engineered for ease of travel, including pulling your recreational equipment. Yukon offers a maximum trailer weight rating of up to 8,500 lbs.¹



YUKON SLT IN WHITE FROST TRICOAT shown with available equipment.

Automatic Locking Differential This feature directs power to the rear wheel with the most traction on loose gravel or slippery surfaces.

Auto Grade Braking It automatically senses when you want to slow your Yukon and engages a Grade Braking shift pattern within the transmission to help maintain your desired speed.

Premium Smooth-Ride Suspension With Air Leveler The available system constantly senses and adjusts Yukon's rear suspension height to maintain a level position. It also contributes to Yukon's max trailering rating.

Hill Start Assist Sensors automatically detect when Yukon is on a 5 percent grade or more. It holds the brakes momentarily, preventing rollback under certain conditions. It's most effective when trailering, providing time to switch from the brake to the accelerator without rolling.

Tow/Haul Mode Providing more power to accelerate when trailering or hauling heavy loads, Tow/Haul mode raises transmission upshift points. It also helps reduce speed by using engine compression to slow Yukon instead of merely braking.

Trailer Sway Control Keep your Yukon and your trailer heading in the same direction, automatically. The system uses StabiliTrak sensors to detect a swaying trailer, applying both Yukon's and the trailer's brakes (if properly equipped) to help bring it back in line.

Trailer Brake Controller For fingertip control and easy monitoring of your trailer brakes, there's an available integrated trailer brake controller. Conveniently located to the left of the steering wheel, it displays the level of brake force or "gain" in the Driver Information Center.

¹Requires Yukon 2WD model with 5.3L V-8 and Heavy-Duty Trailering Package. Before you buy a vehicle or use it for trailering, carefully review the trailering section of the Owner's Manual. The weight of passengers, cargo and options or accessories may reduce the amount you can tow.



FUNCTIONALITY

YOUR LIFE INVOLVES CARRYING QUITE A LOAD: THE KIDS FROM PLACE TO PLACE AND LOTS AND LOTS OF PACKAGES. YUKON HELPS YOU JUGGLE THEM ALL WITHOUT ACTUALLY JUGGLING THEM.



YUKON DENALI IN SATIN STEEL METALLIC shown with available equipment.



YOU ONLY HAVE TWO HANDS

To help you load up while your hands are full, Yukon Denali and SLT include a hands-free, power programmable liftgate. Once the liftgate is open, Yukon makes it easy to lower the second row with an easy-to-use, power-release fold-and-tumble feature, and the third row lowers with the touch of a button to create a flat cargo floor. And since we all travel with plenty of things we just can't leave behind, you'll find generous storage compartments, including an expansive center console as well as power outlets, integrated throughout Yukon.

- + Three-Prong 110-Volt Outlet
- + Under-Floor Cargo Management System and Cargo Net
- + Hidden Storage Behind the Center-Mounted Display; Includes USB¹ Outlet

¹Not compatible with all devices.



YUKON XL SLT INTERIOR IN COCOA/DUNE
shown with available equipment.

PEOPLE TO CARGO WITH THE TOUCH OF A BUTTON

Yukon's available third-row power fold-flat seats turn generous passenger room into an equally generous cargo area. For even more flexibility, second-row seats offer an easy-to-use, power-release fold-and-tumble feature. To provide second-row passengers with easier access, Yukon is designed with large second-row doors.

- + Seat up to Eight With a Second-Row Bench Seat or up to Nine in SLE With a First-Row Bench Seat
- + Lower the Second and Third Rows for a Flat Cargo Area
- + Hands-Free Programmable Power Liftgate Is Available for Access to the Cargo Area

TECHNOLOGY AT YOUR FINGERTIPS, YOUR EYES, YOUR EARS AND YOUR VOICE

The idea behind the design and engineering of Yukon is to help you focus solely on the road. That means offering technologies that allow you to keep your eyes on the road while keeping you connected, informed and entertained at the same time.



Customizable Driver Display Yukon Denali features a reconfigurable gauge cluster with three selectable themes—Standard, Technology and Media. Personalize the 8" diagonal Customizable Driver Display for optimized information placement.

Phone Integration Yukon offers Apple CarPlay™ and Android Auto™ compatibility.¹ With Apple CarPlay™ (shown below), the apps you love on your iPhone® come alive through Siri® or the built-in display, while Android Auto easily integrates the power and functionality of your Android™ phone into Yukon. Just plug into the USB² outlet and go.



Navigation³ In response to your voice or touch, Yukon's available Navigation System displays 2-D or 3-D map graphics on the 8" diagonal center-mounted screen. NavTraffic⁴ (3 trial months of SiriusXM) incorporates real-time traffic and road conditions, directing you toward the most efficient route.

GMC Infotainment System⁵ The GMC Infotainment System features an 8" full-color diagonal screen for easy viewing and hands-free, voice-activated control of your smartphone. Stream music, sync MP3 music, receive vocalized text messages, benefit from Siri® Eyes Free⁶ assistance, connect libraries from multiple devices and store phone contacts.



Bose Centerpoint® Surround Sound For the sensation of a live performance, Denali includes a 10-speaker surround sound system with SurroundStage® signal processing. SLT and SLE feature nine premium speakers and a center-mounted subwoofer for rich bass tones and an enhanced listening experience.

Multicolor Head-Up Display (HUD) This standard Denali feature projects essential driving information at eye level so your eyes stay on the road.



Rear-Seat Entertainment System This available system includes Blu-ray/DVD player, 9.2" diagonal display, digital headphones, HDMI-hardwired connector as well as the ability to project devices wirelessly. Yukon XL features two screens, one specifically for third-row passengers.

Wireless Charging Mat⁷ With wireless charging (only on Denali) conveniently located on the center console, you can power up your compatible phone or device anytime the vehicle is running.



¹Vehicle user interfaces are products of Apple® and Google™ and their terms and privacy statements apply. Requires compatible smartphone. Data plan rates apply. ²Not compatible with all devices. ³Map coverage available in the United States, Puerto Rico and Canada. ⁴If you decide to continue service after your trial, the subscription plan you choose will automatically renew thereafter and you will be charged according to your chosen payment method at then-current rates. Fees and taxes apply. To cancel, you must call SiriusXM at 1-866-635-2349. See SiriusXM Customer Agreement for complete terms at siriusxm.com. All fees and programming subject to change. Sirius, XM, SiriusXM and all related marks and logos are trademarks of SiriusXM Radio, Inc. ⁵Full functionality requires compatible Bluetooth® and smartphone. Some devices require USB connectivity. Data plan rates apply. ⁶Requires GMC Infotainment System and compatible iPhone® running iOS 6 or newer. ⁷The system wirelessly charges one PMA- or Qi-compatible mobile device. Some devices require an adapter or back cover. To check for phone or other device compatibility, visit my.gmc.com/learn for details.



YUKON DENALI INTERIOR IN JET BLACK shown with available equipment.



IN TOUCH

Yukon offers a 4G Wi-Fi® hotspot¹ to keep you connected, informed and entertained – on the go. There's also the GMC Infotainment System,² with an 8" diagonal full-color touch-screen that provides seamless hands-free integration of digital devices. Yukon Denali adds an 8" Customizable Driver Display so you can choose the information you see and how you see it. Denali also includes a multicolor Head-Up Display to help keep relevant information in your vision and your eyes focused on the road.

- + 8" Diagonal Customizable Driver Display (Denali)
- + Wireless Charging Mat³ Keeps You Powered Up (Denali)
- + Bose Centerpoint Surround Sound System (Denali)
- + Bluetooth⁴ Hands-Free Audio Streaming
- + Teen Driver System Helps Encourage Safe Driving Habits

¹Requires a compatible mobile device, active OnStar service and data plan. 4G service available in select markets. Visit onstar.com for coverage map, details and system limitations. Data plan provided by AT&T. ²Full functionality requires compatible Bluetooth and smartphone. Some devices require USB connectivity. Data plan rates apply. ³The system wirelessly charges one PMA- or Qi-compatible mobile device. Some devices require an adapter or back cover. To check for phone or other device compatibility, visit my.gmc.com/learn for details. ⁴Go to my.gmc.com/learn to find out which phones are compatible with the vehicle.

PROACTIVE BEATS REACTIVE

Yukon offers a comprehensive array of driver-alert technologies, engineered with the idea that the best way to handle a collision is to avoid it.

Forward Collision Alert The available feature warns you when you're rapidly approaching another vehicle and it detects a collision is imminent. It also provides an alert if you're following a detected vehicle much too closely.

Low Speed Forward Automatic Braking If the vehicle is traveling at a low speed and the available system detects that a front-end collision situation is imminent while following a detected vehicle, and you haven't applied the brakes, the system automatically applies the brakes to help reduce the collision's severity. The system may even help to avoid the collision at very low speeds.

Front Park Assist This feature alerts you to objects in front of the vehicle while parking.

Adaptive Cruise Control This available feature enhances regular cruise control to allow the vehicle to automatically follow a detected vehicle ahead at the driver-selected following gap while you steer, reducing the need to frequently brake and accelerate.

Lane Keep Assist With Lane Departure Warning This available technology provides gentle steering wheel turns (and Lane Departure Warning alerts if necessary) to help you avoid crashes due to unintentionally drifting out of your lane when you are not actively steering and your turn signal is not activated.

Lane Change Alert With Side Blind Zone Alert This available innovation provides side-mirror alerts to help you avoid crashing into a moving vehicle detected in your side blind spot (or zone) or a vehicle that is rapidly approaching your side blind spot during a lane-change maneuver.

Safety Alert Seat The available GM-patented Safety Alert Seat provides you with the option of getting haptic seat-bottom vibration pulses instead of audible crash-avoidance alerts.

Rear Park Assist This feature alerts you to objects behind the vehicle.

Rear Cross Traffic Alert When in Reverse, the available system provides alerts to help you avoid crashing into approaching cross traffic detected from the left or the right (e.g., out of a crowded parking space or driveway with side obstructions).

Enhanced Security Package To help ensure that it remains in your possession, Yukon surrounds itself with this available package that includes glass breakage sensors, vertical movement sensors, interior motion detectors, door and liftgate lock shields and numerous other theft-deterrent technologies to keep potential thieves at bay.

Rear Vision Camera System The center screen serves as a helpful monitor for the rear-vision camera. It helps you see what's behind you when backing up.

Safety features are no substitute for the driver's responsibility to operate the vehicle in a safe manner. The driver should remain attentive to traffic, surroundings and road conditions at all times. Read the vehicle Owner's Manual for important feature limitations and information.

FINE TUNING

Available individually or as part of a package, GMC Accessories are the best way to customize and personalize your Yukon. They're engineered and tested to meet the standards of your Yukon.



Exhaust Tip This stainless-steel, highly polished, dual-wall, angle-cut exhaust tip adds a sporty appearance to the exterior of your Yukon. Use only on GMC's Original Equipment exhaust system.



Floor Liners—Premium All-Weather Help keep the front floor of your Yukon clean with these premium all-weather floor liners in Black with GMC logo.



Floor Mats—Cargo-Area Premium All-Weather Help protect the carpet in the cargo area of your Yukon from rain, snow, mud and other debris with this precision-designed premium all-weather cargo-area mat.



Chrome Mirror Covers Help your Yukon make even more of a fashion statement with these chrome outside rearview mirror covers. Set of two.



Cargo Security Shade Conceal your possessions in the cargo area of your Yukon with this retractable cargo shade. Tension-rod extensions allow for easy installation and removal.



Chrome Assist Steps Customize your Yukon with these stylish 6" rectangular chrome assist steps. Crafted from rust-resistant stainless steel with black textured step pads. Black also available.



SF1 Accessory Wheel¹
22" 7-spoke Silver



SEV Accessory Wheel¹
22" 6-spoke High-Gloss Black



SEW Accessory Wheel¹
22" 5 split-spoke Ultra-Bright
Machined High-Gloss Black



RX1 Accessory Wheel¹
22" 7-spoke Silver with
Black Inserts



RXN Accessory Wheel¹
22" 7-spoke Aluminum with
Chrome Inserts



SF0 Accessory Wheel¹
22" 6 split-spoke Ultra-Bright
Machined Manooigan Silver

¹Use only GM-approved tire and wheel combinations. Unapproved combinations may change the vehicle's performance characteristics. For approved tire and wheel combinations and other important information, go to gmaccessories.com or see your dealer for details.

INSTRUMENT PANEL ACCENTS



Axiom Aluminum

Burnished Aluminum

DOOR AND CONSOLE ACCENTS



Periwood Wood Tone

Grand Lace Wood Tone

Mastique Ash Wood

INTERIOR COLORS/SEATING SURFACES CLOTH



Cocoa/Dune Cloth

Jet Black/Jet Black Cloth

LEATHER APPOINTMENTS

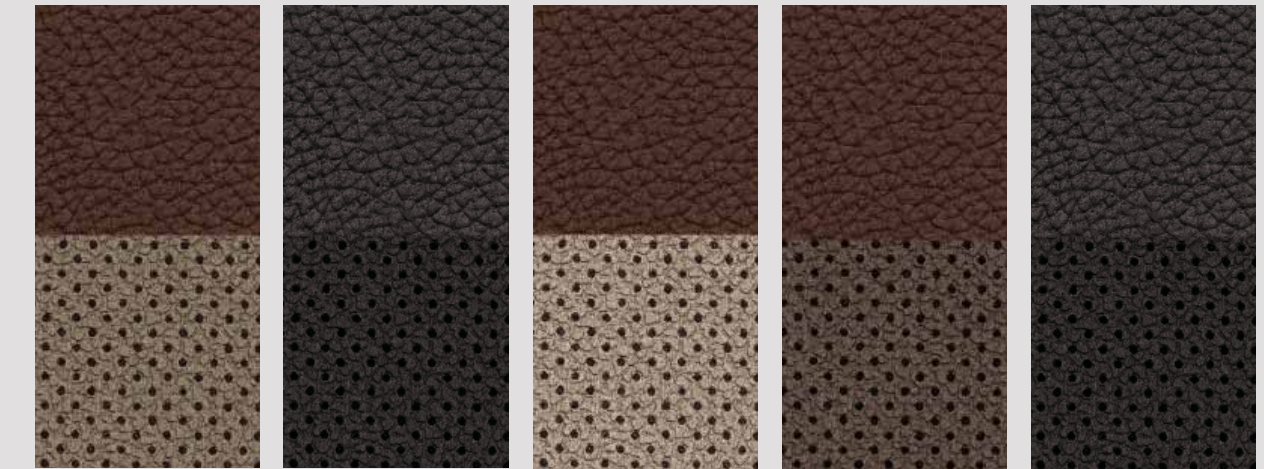

Cocoa/Dune Perforated Leather-Appointed

Jet Black/Jet Black Perforated Leather-Appointed

Cocoa/Shale Perforated Leather-Appointed With Unique Denali Accents

Cocoa/Dark Atmosphere Perforated Leather-Appointed With Unique Denali Accents

Jet Black/Jet Black Perforated Leather-Appointed With Unique Denali Accents

MODELS

SLE	●	—	●	● ²	—	●	●	—	—	—	—
SLT	●	—	● ¹	● ²	—	—	—	●	●	—	—
DENALI	—	●	—	—	●	—	—	—	●	●	●

KEY ● STANDARD ○ AVAILABLE — NOT AVAILABLE ¹Included with Cocoa/Dune interior trim. ²Included with Jet Black interior trim.

EXTERIOR COLORS See your GMC dealer for more exterior color details and availability.



Mineral Metallic^{3,4}



Dark Sapphire Blue Metallic³

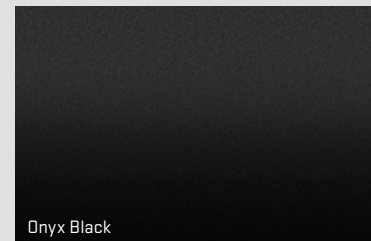

Onyx Black



Quicksilver Metallic³

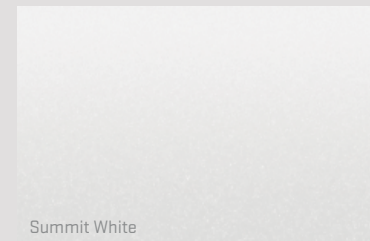

Summit White

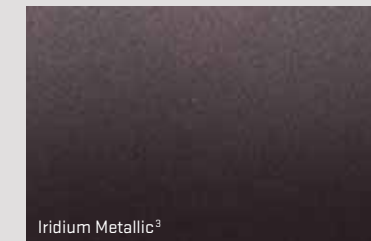

Iridium Metallic³



Crimson Red Tintcoat³



Satin Steel Metallic³



White Frost Tricoat⁵

³Additional charge, premium paint. ⁴Denali models only. ⁵Additional charge, premium paint. Not available on SLE trim.

THE BEST AND THE BRIGHTEST

Crafting the 2018 Yukon means precisely engineering every inch of it from the ground up—including its wheels. That's why you'll find GMC wheels available in a range of styles. Your dealer can provide more wheel availability details.



18" Bright Machined Aluminum (UHN)
Standard on SLE and SLT



20" Polished Aluminum (RD5)
Available on SLE and SLT



20" Ultra-Bright Machined Aluminum (NZG)
Standard on Denali



20" Chrome Aluminum (RTL)
Available on Denali



22" Ultra-Bright Machined Aluminum With Midnight Silver Premium Paint (SII)
Available on Denali



22" 6-Spoke Chrome (RPT)
Available on SLE, SLT and Denali



22" 6-Spoke Chrome (SMI)
Available on SLE, SLT and Denali



22" 6-Spoke Split Chrome (SEU)
Included and only available with SLT Premium Edition

YUKON SPECIFICATIONS

MECHANICAL

	SLE	SLT	DENALI
ACTIVE AERO GRILLE SHUTTERS	●	●	●
ALTERNATOR 150-amp	●	●	—
170-amp	—	—	●
BATTERY Heavy-duty maintenance-free with rundown protection	●	●	●
BRAKES 4-wheel Antilock Brake System (ABS), 4-wheel disc with Duralife rotors	●	●	●
DRIVETRAIN 2WD	●	●	●
4WD. Single-speed active transfer case.	○	○	—
4WD. Active 2-speed transfer case with rotary controls. Included and only available with the Heavy-Duty Trailing Package on SLE and SLT trims.	○	○	○
ENGINES 5.3L V-8 EcoTec3 with aluminum block. Includes Active Fuel Management, Direct Injection and continuously Variable Valve Timing.	●	●	—
6.2L V-8 EcoTec3 with aluminum block. Includes Active Fuel Management, Direct Injection and continuously Variable Valve Timing.	—	—	●
ENGINE BLOCK HEATER	○	○	○
EXTERNAL ENGINE OIL COOLER Heavy-duty air-to-oil, integral to radiator	●	●	●
HEAVY-DUTY AUTOMATIC LOCKING REAR DIFFERENTIAL	●	●	●
STABILITRAK Stability control system and traction control. Includes Trailer Sway Control and Hill Start Assist.	●	●	●
STEERING Electric, power	●	●	●
SUSPENSION Front independent coil-over-shock with stabilizer bar	●	●	●
Rear multilink with coil springs	●	●	●
Premium Smooth Ride Suspension	●	●	—
Automatic Rear Level Control, air. On SLE and SLT, included and only available with the Heavy-Duty Trailing Package.	○	○	—
Magnetic Ride Control. Includes automatic air-level control.	—	—	●
TRAILERING Trailer brake controller, integrated. On SLE and SLT, included and only available with the Heavy-Duty Trailing Package.	○	○	●
Trailing Equipment. Includes hitch platform with 2" trailing receiver and 7-wire harness with independent fused trailing circuits mated to a 7-way sealed connector.	●	●	●
TRANSMISSION 6-speed automatic, electronically controlled with overdrive, Tow/Haul mode, Electronic Engine Grade Braking and tap-up/tap-down shifting	●	●	—
10-speed automatic, electronically controlled with overdrive, Tow/Haul mode, Electronic Engine Grade Braking and tap-up/tap-down shifting	—	—	●

SEATING

SEATS Front buckets with Premium Cloth. Includes 10-way power driver seat, 6-way power cushion, 2-way power lumbar control and power recline. Front-passenger seat is 6-way power.	●	—	—
Front 40/20/40 split bench with Premium Cloth. Includes 10-way power driver-seat adjuster, 6-way power passenger-seat adjuster, center fold-down armrest with storage, lockable storage compartments in seat cushion (includes auxiliary power outlet), adjustable outboard head restraints and storage pockets.	○	—	—
Front heated and ventilated perforated leather-appointed seating. Includes full-feature reclining buckets with 12-way power driver and front-passenger seat adjuster, including 6-way power cushion, 2-way power recline and 4-way power lumbar for driver and front passenger. Includes driver memory feature (no memory on lumbar).	—	●	●
Heated second-row seats. Outboard positions.	—	●	●
Second-row 60/40 split-folding bench with manual operation	●	—	—
Second-row 60/40 split-folding bench with power release	—	●	○
Second-row buckets with power release	—	○	●
Third-row 60/40 manual split-folding bench	●	—	—
Third-row 60/40 split bench with power-folding seatback	—	●	●

KEY ● STANDARD ○ AVAILABLE — NOT AVAILABLE

INSTRUMENTATION AND CONTROLS

	SLE	SLT	DENALI
ADAPTIVE CRUISE CONTROL With Forward Automatic Braking to maintain a preset following distance	—	○	○
HEAD-UP DISPLAY Includes digital multifunction readouts	—	—	●
INSTRUMENTATION Includes speedometer, odometer/trip odometer, fuel level, voltmeter, engine temperature, oil pressure and tachometer. Driver Information Center includes 4.2" diagonal multicolor display on SLE and SLT.	●	●	●
8" diagonal Customizable Driver Display	—	—	●
POWER-ADJUSTABLE PEDALS On SLE, included and only available with Convenience Package	○	●	●
PUSH-BUTTON KEYLESS START	—	●	●
REAR VISION CAMERA SYSTEM	●	●	●
STEERING WHEEL Leather-wrapped, with controls for audio, Driver Information Center, cruise control and Bluetooth®-enabled ¹ phone	●	●	●
Heated steering wheel	—	●	●
Tilt-adjustable steering column with brake/transmission shift interlock	●	—	—
Power-tilt and -telescopic steering column	—	●	●
TEEN DRIVER A configurable feature that lets you activate customizable vehicle settings associated with a key fob, to help encourage safe driving behavior. It can limit certain vehicle features, and it automatically turns on certain available safety systems in the vehicle. An in-vehicle Report Card gives you information on your teen's driving habits and helps you to continue to coach your new driver.	●	●	●
TOW/HAUL MODE SELECTOR	●	●	●
FRONT AND REAR PARK ASSIST	●	●	●

INTERIOR DETAILS AND CONVENIENCE FEATURES

ACTIVE NOISE CANCELLATION	—	—	●
CARPET Color-keyed with removable carpeted floor mats for first and second rows	●	●	●
CLIMATE CONTROL Tri-zone automatic air conditioning. Includes individual climate settings for driver, front passenger and rear passengers.	●	●	●
Defogger, rear-window electric	●	●	●
CONSOLE Floor with storage area and cupholders. Included and only available with front bucket seats.	●	●	●
CUPHOLDERS Front seating area, rear floor console, third-row outboard side trim	●	●	●
MIRROR Inside rearview with manual day/night	●	—	—
Auto-dimming rearview. On SLE, included and only available with Convenience Package or SLE Value Package.	○	●	●
OUTLETS 12-volt power, 5 (4 with front bench seat)	●	●	●
3-prong household style 110-volt, 1.1-amp, 150-watt	●	●	●
PASSIVE ENTRY SYSTEM Includes remote keyless entry	—	●	●
POWER PROGRAMMABLE DOOR LOCKS Includes lockout protection	●	●	●
POWER WINDOWS With all express-down and front express-up	●	●	●
REMOTE VEHICLE START SYSTEM With keyless entry	●	●	●
SUNROOF Power, tilt-sliding with express-open and -close and wind deflector. On SLT and Denali, included with Open Road Package.	—	○	○
UNIVERSAL HOME REMOTE Includes programmable garage-door opener. On SLE, included and only available with Convenience Package.	○	●	●
WIRELESS CHARGING MAT² Center console-mounted. Not compatible with all phones.	—	—	●

¹Go to my.gmc.com/learn to find out which phones are compatible with the vehicle. ²The system wirelessly charges one PMA- or Qi-compatible device. Some devices require an adapter or back cover. To check for phone or other device compatibility, visit my.gmc.com/learn for details.

	SLE	SLT	DENALI
--	-----	-----	--------

ENTERTAINMENT/COMMUNICATION/NAVIGATION

AUDIO SYSTEM 8" diagonal color touch-screen with GMC Infotainment System, ¹ AM/FM/SiriusXM ² 3-month trial with up to 5 USB ³ ports and auxiliary jack. Includes text-message alerts, Siri [®] Eyes Free [®] functionality through voice command, Bluetooth [®] streaming audio for music and most phones, hands-free smartphone integration, voice-activated technology for radio and phone and an articulating screen with hidden storage.	●	●	–
8" diagonal color touch-screen with GMC Infotainment System ¹ and Navigation, ⁵ AM/FM/SiriusXM ² 3-month trial with up to 5 USB ³ ports and auxiliary jack. Includes text-message alerts, Siri [®] Eyes Free [®] functionality through voice command, Bluetooth [®] streaming audio for music and most phones, hands-free smartphone integration, voice-activated technology for radio and phone and an articulating screen with hidden storage. On SLT, included with Open Road Package.	–	○	●
HD Radio	●	●	●
CD player. On SLT, deleted when Open Road Package or Rear-Seat Entertainment System is ordered. On Denali, deleted when Denali Ultimate Package, Open Road Package or Rear-Seat Entertainment System is ordered.	●	●	●
Bose [®] premium 9-speaker sound system with subwoofer in center console	●	●	–
Bose Centerpoint [®] surround sound premium 10-speaker sound system	–	–	●
REAR-SEAT ENTERTAINMENT SYSTEM Includes Blu-ray/DVD player, overhead 9.2" diagonal screen, Wi-Fi [®] wireless projection capability with select devices, Video Voice Over, remote control, 2 2-channel wireless digital headphones (4 headphones on XL), rear-seat audio controls, auxiliary HDMI/MHL audio/video input and 2 USB ³ ports. Included with Open Road Package or Denali Ultimate Package. Replaces CD player.	–	○	○
9.2" diagonal screen, third row. Included and only available with Rear-Seat Entertainment System on XL models.	–	○	○
4G[®] WI-FI HOTSPOT CAPABILITY See your dealer for more details	●	●	●
SIRIUSXM SATELLITE RADIO² 3 trial months included	●	●	●

PACKAGES

DENALI ULTIMATE PACKAGE Includes Open Road Package contents: additional 9 months of SiriusXM radio ² and NavTraffic service ² ; power sunroof and Rear-Seat Entertainment System; Enhanced Security Package contents: self-powered horn and interior movement and vehicle inclination sensors; power-retractable assist steps, Adaptive Cruise Control with Forward Automatic Braking and 22" (SII) Ultra-Bright Machined Aluminum wheels with Midnight Silver premium paint. Deletes CD player when ordered.	–	–	○
SLT PREMIUM EDITION Includes 22" (SEU) 6-spoke split chrome accessory wheels, bright bodyside moldings, accessory chrome grille insert and polished exhaust tip	–	○	–
SLE VALUE PACKAGE Includes inside rearview auto-dimming mirror, power-adjustable pedals, power liftgate, Universal Home Remote and 20" (RD5) polished aluminum wheels	○	–	–
HEAVY-DUTY TRAILERING PACKAGE (NHT) Includes 3.42 rear axle ratio, trailer brake controller, increased-capacity suspension with rear air level control and 2-speed AutoTrac transfer case on 4WD models	○	○	–
CONVENIENCE PACKAGE Includes inside auto-dimming rearview mirror, power-adjustable pedals, power liftgate and Universal Home Remote	○	–	–
ENHANCED DRIVER ALERT PACKAGE Includes Forward Collision Alert, Lane Keep Assist with Lane Departure Warning, Safety Alert Seat, IntelliBeam headlamps and Low Speed Forward Automatic Braking. When Adaptive Cruise Control is ordered on SLT and Denali, Low Speed Forward Automatic Braking is replaced with Forward Automatic Braking.	○	●	●
ENHANCED SECURITY PACKAGE Includes body security content, theft-deterrent system, self-powered horn, interior movement and vehicle inclination sensors, door and liftgate lock shields and glass breakage sensors in rear quarter glass and liftgate window. Removes sunglass holder and conversation mirror from overhead console.	–	○	○
OPEN ROAD PACKAGE Includes additional 9 months of SiriusXM Radio ² and NavTraffic ² service, power sunroof, Rear-Seat Entertainment System and audio system with Navigation ⁶ on SLT trim	–	○	○
MEMORY PACKAGE Includes memory for driver seat, steering column, exterior rearview mirrors and pedals.	–	●	●

KEY ● STANDARD ○ AVAILABLE – NOT AVAILABLE

EXTERIOR STYLING AND FUNCTIONALITY

ASSIST STEPS Black with chrome inserts	●	●	●
Power-retractable with bright accent strip and LED perimeter lighting	–	–	○
GLASS Solar-Ray deep-tinted. All windows except light-tinted glass on windshield and driver- and front-passenger-side glass.	●	●	●
LIGHTS Halogen projector-beam headlamps with automatic exterior lamp control, LED signature lighting and flash-to-pass	●	●	–
HID projector-beam headlamps with automatic exterior lamp control, LED signature lighting and flash-to-pass	–	–	●
Halogen front fog lamps	●	●	●
IntelliBeam, automatic high-beam on/off. On SLE, included and only available with Enhanced Driver Alert Package.	○	●	●
LUGGAGE RACK Roof-mounted side rails, black; black with bright accent on Yukon Denali	●	●	●
MOLDINGS Bodyside includes bright inserts. On SLT, included with SLT Premium Edition.	○	○	●
Bodyside, body-color	○	○	–
EXTERIOR MIRRORS Heated, power-adjustable, manual-folding, body-color. Includes driver-side spotter mirror.	●	–	–
Heated power-folding, power-adjustable, driver-side auto-dimming, body-color mirrors with integrated turn-signal indicators, ground illumination and curb-tilt	–	●	●
POWER PROGRAMMABLE LIFTGATE On SLE, included and only available with Convenience Package or SLE Value Package	○	●	●
Hands-free liftgate capability	–	●	●
WIPERS Front rain-sensing intermittent wet-arm with flat blade and pulse washers	●	●	●
Rear intermittent with washer	●	●	●

SAFETY AND SECURITY

AIR BAGS⁸ Dual-stage frontal with Passenger Sensing System	●	●	●
Front center air bag. Not included with available front 40/20/40 split bench on SLE.	●	●	●
Front and rear head-curtain air bags for all outboard seating positions with rollover sensor	●	●	●
Front-seat-mounted side-impact driver and front-passenger air bags for thorax and pelvis protection	●	●	●
FORWARD COLLISION ALERT AND LANE KEEP ASSIST WITH LANE DEPARTURE WARNING On SLE, included and only available with Enhanced Driver Alert Package	○	●	●
LOW SPEED FORWARD AUTOMATIC BRAKING On SLE, included and only available with Enhanced Driver Alert Package	○	●	●
FORWARD AUTOMATIC BRAKING Included and only available with Adaptive Cruise Control	–	○	○
REAR CROSS TRAFFIC ALERT	–	●	●
SAFETY ALERT SEAT On SLE, included and only available with Enhanced Driver Alert Package	○	●	●
LANE CHANGE ALERT WITH SIDE BLIND ZONE ALERT	–	●	●
TIRE PRESSURE MONITORING SYSTEM Includes Tire Fill Alert. Does not monitor spare tire.	●	●	●
VEHICLE THEFT-DETERRENT SYSTEM Electrical unauthorized entry	●	●	●

¹Full functionality requires compatible Bluetooth and smartphone. Some devices require USB connectivity. Data plan rates apply. ²If you decide to continue service after your trial, the subscription plan you choose will automatically renew thereafter and you will be charged according to your chosen payment method at then-current rates. Fees and taxes apply. To cancel, you must call SiriusXM at 1-866-635-2349. See SiriusXM Customer Agreement for complete terms at siriusxm.com. All fees and programming subject to change. For more information about NavTraffic, visit siriusxm.com/navtraffic. For more information about Travel Link, visit siriusxm.com/travellink. Sirius, XM, SiriusXM and all related marks and logos are trademarks of SiriusXM Radio, Inc. ³Not compatible with all devices. ⁴Requires GMC Infotainment System and compatible iPhone[®] running iOS 6 or newer. ⁵Go to my.gmc.com/learn to find out which phones are compatible with the vehicle. ⁶Map coverage available in the United States, Puerto Rico and Canada. ⁷Requires a compatible mobile device, active OnStar service and data plan. 4G service available in select markets. Visit onstar.com for coverage map, details and system limitations. Data plan provided by AT&T. ⁸A NOTE ON CHILD SAFETY: Always use safety belts and the correct restraint for your child's age and size, even with air bags. Even in vehicles equipped with the Passenger Sensing System, children are safer when properly secured in a rear seat in the appropriate infant, child or booster seat. Never place a rear-facing infant restraint in the front seat of any vehicle equipped with an active frontal air bag. See your vehicle Owner's Manual and child safety seat instructions for more safety information.

YUKON/YUKON XL/YUKON DENALI/YUKON XL DENALI ENGINE SPECIFICATIONS

	L83	L86
ENGINE	EcoTec3 5.3L V-8 DI, VVT, AFM	EcoTec3 6.2L V-8 DI, VVT, AFM
HP @ RPM	355 @ 5,600	420 @ 5,600
LB-FT TORQUE @ RPM	383 @ 4,100	460 @ 4,100
ACTIVE FUEL MANAGEMENT	Included	Included
EPA-ESTIMATED CITY/HWY MPG		
SHORT WHEELBASE		
2WD	16/23 GAS	14/23
4WD	16/22 GAS	14/22
LONG WHEELBASE		
2WD	16/23 GAS	14/23
4WD	15/22 GAS	14/21
STANDARD	YUKON YUKON XL	YUKON DENALI YUKON XL DENALI

YUKON/YUKON XL/YUKON DENALI/YUKON XL DENALI TRANSMISSION SPECIFICATIONS

MODEL	DRIVETRAIN/TRANSMISSION
SLE/SLT	2WD or 4WD/ 6-speed electronically controlled automatic with Driver Shift Control, Electronic Engine Grade Braking and Tow/Haul mode
Denali	2WD or 4WD/ 10-speed electronically controlled automatic with Driver Shift Control, Electronic Engine Grade Braking and Tow/Haul mode

MEASUREMENTS/CAPACITIES

	2WD/4WD YUKON	2WD/4WD YUKON XL	2WD/4WD YUKON DENALI	2WD/4WD YUKON XL DENALI
WHEELBASE in.	116.0	130.0	116.0	130.0
MAXIMUM CARGO VOLUME¹⁰ cu. ft. Behind first/second/third row	94.7/51.7/15.3	121.7/76.7/39.3	94.7/51.7/15.3	121.7/76.7/39.3
OVERALL LENGTH in.	203.9	224.4	203.9	224.4
OVERALL WIDTH in.	80.5	80.5	80.5	80.5
HEIGHT in.	74.4	74.4	74.4	74.4
FUEL TANK CAPACITY approx. gallons	26.0	31.0	26.0	31.0

MAXIMUM TRAILER WEIGHT RATINGS¹¹

MODEL	YUKON		YUKON XL		YUKON DENALI/YUKON XL DENALI	
	EcoTec3 5.3L		EcoTec3 5.3L		EcoTec3 6.2L	
	AXLE RATIO	MAX. TRAILER WEIGHT (LBS)	AXLE RATIO	MAX. TRAILER WEIGHT (LBS)	AXLE RATIO	MAX. TRAILER WEIGHT (LBS)
YUKON 2WD	3.08/3.42	6,500/8,500	3.08/3.42	6,300/8,300	–	–
YUKON 4WD	3.08/3.42	6,300/8,200	3.08/3.42	6,000/8,000	–	–
DENALI 2WD	–	–	–	–	3.23	8,400/8,100
DENALI 4WD	–	–	–	–	3.23	8,100/7,900

¹⁰Cargo and load capacity limited by weight and distribution. ¹¹Before you buy a vehicle or use it for trailering, carefully review the trailering section of the Owner's Manual. The weight of passengers, cargo and options or accessories may reduce the amount you can tow.

PEACE OF MIND

GMC Pro Grade Protection is standard on every 2018 Yukon. From maintenance to protecting your entire vehicle, you can drive with confidence.

INCLUDES 2 MAINTENANCE VISITS DURING THE FIRST 2 YEARS/24,000 MILES¹

3-YEAR/36,000-MILE BUMPER-TO-BUMPER LIMITED WARRANTY²

5-YEAR/60,000-MILE POWERTRAIN LIMITED WARRANTY²

5-YEAR/60,000-MILE ROADSIDE ASSISTANCE/COURTESY TRANSPORTATION²

¹Maintenance visits must occur within 2 years or 24,000 miles of vehicle delivery, whichever comes first. Does not include air filters. See participating dealer for other restrictions and complete details. ²Whichever comes first. See dealer for limited-warranty details.



WE'RE AS CLOSE AS THE BLUE BUTTON

Connect to a specially trained OnStar¹ Advisor just by pushing the blue OnStar button in your Yukon.

Emergency: Help When It Matters Most. OnStar protects you and your passengers in the event of an emergency with the right help, right when you need it.

Automatic Crash Response.² Using built-in sensors, Automatic Crash Response can connect you to an OnStar Advisor immediately after a crash to help get you the care you need even if you can't ask for it. Using Injury Severity Prediction technology, professionally trained Advisors can notify first responders about the likelihood of serious injury so they can provide the right help, right away. You can feel confident knowing you have a team, 24/7, to get you the assistance you need.

Roadside Assistance.³ If you've got a flat tire or are low on gas, just push the blue OnStar button, and an Advisor will get things moving with Roadside Assistance. We can use GPS technology to pinpoint where you are and send a tow truck or whatever help you need. No matter how far you are from home, you're empowered with solutions that keep you moving.

Crisis Assist. During severe weather or a crisis, OnStar can provide critical guidance during your time of need. With Crisis Assist,² our Advisors provide a fast, knowledgeable resource for emergency assistance, special routing assistance and other services. We're a 24-hour connection and central point of contact for help when you need it most.

Security: Protection You Can Count On. Breathe easy knowing a comprehensive suite of Stolen Vehicle Assistance services is available to help protect your vehicle.

Stolen Vehicle Assistance.⁴ If your vehicle is stolen, you can be assured OnStar Advisors are ready to take action. Once you report your vehicle stolen, they can pinpoint its location, work with the police to quickly recover it, slow the vehicle if the conditions are safe to do so and even prevent it from restarting. And with Theft Alarm Notification,⁵ if your vehicle alarm sounds, we'll let you know via text, email and/or a phone call. One simple call puts a team into action to help recover your vehicle quickly and safely.

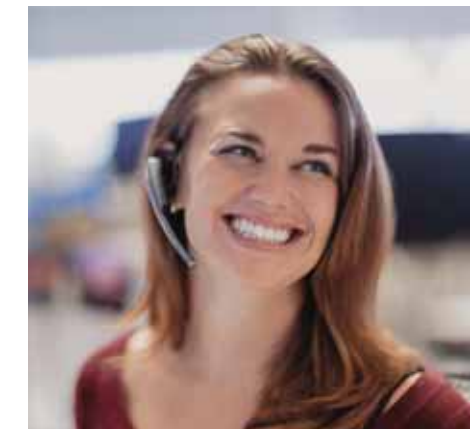

¹Visit onstar.com for coverage map, details and system limitations. Some services require paid OnStar service plan. ²Visit onstar.com for vehicle availability, details and system limitations. OnStar acts as a link to existing emergency service providers. Not all vehicles may transmit all crash data. ³Roadside service provided by Allstate Roadside Services. ⁴Services vary by model and conditions. Visit onstar.com for vehicle availability, details and system limitations. ⁵Services vary by model and conditions. Visit onstar.com for vehicle availability, details and system limitations. Theft Alarm Notification features vary by vehicle. Requires factory-installed theft-deterrent system; Security or Guidance Plan or Stolen Vehicle Assistance Plan Add-On; and selection of notification communication preference(s). Vehicles must be locked electronically to arm the factory-installed theft-deterrent system. Messaging and data rates may apply.

CONVERSATION STARTER

At GMC, we'd like to start a dialogue with you so we can learn more about each other. Join the conversation and share your passion for all things Professional Grade.



GMC.COM



IMPORTANT WORDS

PRO GRADE PROTECTION

For 2018, Yukon comes with the Pro Grade Protection Plan, which includes two maintenance visits,¹ 3-year/36,000-mile Bumper-to-Bumper Limited Warranty² and 5-year/60,000-mile Powertrain Limited Warranty,² Roadside Assistance and Courtesy Transportation.

Starting with the owner orientation—and full tank of gas—you receive when you take possession of your Yukon, to the **24-Hour Roadside Assistance**, **Courtesy Transportation** and **Travel Benefits**, you receive a portfolio of owner privileges that lasts throughout your warranty. For expert product information, Roadside Assistance or other services, call 1-800-GMC-8782.

TRAVEL BENEFITS AND ROADSIDE ASSISTANCE Available around the clock: trip routing service, a program for reimbursement for trip interruption due to necessary warranty repairs, towing, flat tire change, jump-starts and more for 5 years or 60,000 miles (whichever comes first).

COURTESY TRANSPORTATION Available at participating dealers: shuttle service, reimbursement of certain public transportation or fuel expenses for overnight warranty repairs and courtesy rental for overnight work repairs. See your dealer for details.

GMC OWNER CENTER A complimentary, one-stop resource to enhance your GMC ownership experience. It's easy to sign up. Just go to gm.com/gmownercenter/gmc.

ONSTAR

 OnStar services require vehicle electrical system (including battery), wireless service and GPS satellite signals to be available and operating for features to function properly. OnStar service required. OnStar acts as a link to existing emergency service providers. Not all vehicles may transmit all crash data. Visit onstar.com for coverage map, details and system limitations. Services vary by model and conditions.

SIRIUSXM SATELLITE RADIO

 SiriusXM Satellite Radio³ is standard on all Yukon models. It includes 3 trial months of service. SiriusXM Satellite Radio makes your drive come alive with commercial-free music channels from virtually every genre, artist-dedicated channels, live performances and more. Tune in to live play-by-play from the biggest sports, exclusive entertainment from top personalities, compelling talk, hilarious comedy, world-class news, local traffic and weather and family-friendly programming. Welcome to the world of satellite radio. Visit siriusxm.com for details.

GMC CERTIFIED SERVICE

 To help your Yukon live up to its performance promise, GMC Certified Service—found exclusively at your GMC dealer—is there. With all the engineering excellence in Yukon, GM-trained technicians have the expertise to care for all of it.

ADDITIONAL NOTES

A NOTE ON CHILD SAFETY Always use safety belts and the correct child restraint for your child's age and size, even with air bags. Even in vehicles equipped with the Passenger Sensing System, children are safer when properly secured in a rear seat in the appropriate infant, child or booster seat. Never place a rear-facing infant restraint in the front seat of any vehicle equipped with an active frontal air bag. See your vehicle Owner's Manual and child safety seat instructions for more safety information.

TRAILERING AND OFF-ROAD INFORMATION Please carefully review the Owner's Manual for important safety information about trailering or off-road driving in your vehicle.

FLEET ORDERS Some standard content may be deleted with fleet orders. See dealer for details.

ENGINES GMC products are equipped with engines produced by GM Powertrain or other suppliers to GM worldwide. The engines in GMC products may also be used in other GM makes and models.

GMC.COM See more of Yukon on our website: gmc.com/yukon. More photos and information; hot links to related subjects; convenient dealer locator; pricing guide, spec out your own vehicle. Or call 1-800-GMC-8782.

BUYPOWER CARD™



Now it's even easier to get into the GMC of your dreams. Every purchase gives you Earnings redeemable toward part or even all of a new GMC, Chevrolet, Buick or Cadillac. Every year, enjoy 5 percent Earnings on your first \$5,000 in purchases and 2 percent unlimited Earnings after that. No expiration on Earnings and no limit on how much you can earn or redeem. Learn more at buypowercard.com/catalog. YOUR CARD IS THE KEY.™

IMPORTANT WORDS ABOUT THIS CATALOG We have tried to make this catalog comprehensive and factual. We reserve the right, however, to make changes at any time, without notice, in prices, colors, materials, equipment, specifications, models and availability. Specifications, dimensions, measurements, ratings and other numbers in this catalog and other printed materials provided at the dealership or affixed to vehicles are approximates based upon design and engineering drawings and prototypes and laboratory tests. Your vehicle may differ due to variations in manufacture and equipment. Since some information may have been updated since the time of printing, please check with your GMC dealer for complete details. GMC reserves the right to lengthen or shorten the model year for any product for any reason, or to start and end model years at different times. All competitive claims are based on the latest information available at the time of printing and GM Large SUV segment.

AN IMPORTANT NOTE ABOUT ALTERATIONS AND WARRANTIES Installations or alterations to the original equipment vehicle (or chassis) as distributed by General Motors are not covered by the General Motors New-Vehicle Limited Warranty. The special body company, assembler, equipment installer or upfitter is solely responsible for warranties on the body or equipment and any alterations (or any effect of the alterations) to any of the parts, components, systems or assemblies installed by GM. General Motors is not responsible for the safety or quality of design features, materials or workmanship of any alterations by such suppliers.

NEW-VEHICLE LIMITED WARRANTY All GMC Yukon models come with a fully transferable, no-deductible 5-year/60,000-mile (whichever comes first) Powertrain Limited Warranty. GM vehicles registered in the USA are also covered for 3 years or 36,000 miles (whichever comes first). Coverage includes tires and towing to your nearest GMC dealership. Repairs will be made to correct any vehicle defect and most warranty repairs will be made at no charge. In addition, rust-through corrosion will be covered for 6 years or 100,000 miles (whichever comes first). Yukon also comes with two maintenance visits within the first 2 years/24,000 miles (whichever comes first).¹ See dealer for details.

ASSEMBLY GMC vehicles and their components are assembled or produced by different operating units of General Motors, its subsidiaries or suppliers to GM worldwide. We sometimes find it necessary to produce GMC vehicles with different or differently sourced components than originally scheduled. Since some options may be unavailable when your vehicle is assembled, we suggest that you verify that your vehicle includes the equipment you ordered or, if there are changes, that they are acceptable to you.

GMMOBILITY.COM (1-800-323-9935) GM Mobility offers financial assistance for eligible adaptive equipment to make automotive travel easier for persons with disabilities or special transportation needs. To learn more about special GM Mobility offers, visit gmmobility.com.

¹Maintenance visits must occur within 2 years or 24,000 miles of vehicle delivery, whichever comes first. Does not include air filters. See participating dealer for other restrictions and complete details. ²Whichever comes first. See dealer for limited-warranty details. ³If you decide to continue service after your trial, the subscription plan you choose will automatically renew thereafter and you will be charged according to your chosen payment method at then-current rates. Fees and taxes apply. To cancel, you must call SiriusXM at 1-866-635-2349. See SiriusXM Customer Agreement for complete terms at siriusxm.com. All fees and programming subject to change. For more information about NavTraffic, visit siriusxm.com/navtraffic. For more information about Travel Link, visit siriusxm.com/travellink. Sirius, XM, SiriusXM and all related marks and logos are trademarks of SiriusXM Radio, Inc.

©2017 General Motors. All rights reserved. GM, the GM logo, GMC, the slogans, emblems, vehicle model names, vehicle body designs and other marks appearing in this catalog are the trademarks and/or service marks of General Motors, its subsidiaries, affiliates or licensors. Facebook is a registered trademark of Facebook, Inc. Twitter is a registered trademark of Twitter, Inc. YouTube is a registered trademark of Google Inc. Instagram is a registered trademark of Instagram, LLC. Android Auto is a trademark of Google Inc. Sirius, XM and all related marks and logos are trademarks of SiriusXM Radio, Inc. Apple, CarPlay, iPhone and Siri are registered trademarks of Apple, Inc.

VISIT US AT GMC.COM

GMC

WE ARE PROFESSIONAL GRADE