



MASERATI



Quattroporte

Quattroporte

CONTENTS

Extraordinary Disposition Quattroporte—An icon of Italian elegance	4
A History of Character	8
Exteriors	12
Interiors	18
Gran Duo Ghibli GranLusso and GranSport	26

Engines	50
Technology	56
The Sound of Quality Harman Kardon and Bowers & Wilkins Premium Audio Systems	64
Safety	68
Quattroporte Technical Specifications	78
The World of Maserati	80



E

EXTRAORDINARY DISPOSITION



GRAND-SCALE ICON

In 1963, Maserati made a remarkably bold move, introducing the first-ever luxury sports sedan. We took a proven racing engine developed for use in our competition cars, mated it with a beautifully designed luxury sedan, and presented our creation to the world at the Turin Motor Show. This was our first Quattroporte—and the reception from the public, press and automotive connoisseurs was rapturous. The excitement was understandable. Until then, Maserati was renowned for its formidable motorsports pedigree, glamorous coupes and striking convertibles. This was new. This was the world's first supersedan.

The Quattroporte met a particular need for a group of discerning motorists. Back then, Europe's emerging network of motorways opened up thrilling possibilities for long-distance journeys. With the Quattroporte, grand touring became an experience to be savored—at high speeds, in spacious comfort and in breathtaking Maserati style.

In today's Maserati Quattroporte, the principles remain much the same. The Quattroporte offers race-bred power from Ferrari-built V6 and V8 engines, while a long wheelbase offers a spacious, elegantly crafted interior of supreme luxury. Every comfort and convenience is provided, from hand-stitched premium Italian Pieno Fiore natural leather to cutting-edge Advanced Driving Assistance Systems, including Highway Assist. Furthermore, the Quattroporte's undeniably athletic yet graceful styling evokes the power and presence the world has come to expect from Maserati. As Maserati continues to shape the future of luxury grand touring, some things clearly never change.





III



A HISTORY OF CHARACTER

The TRUE SPIRIT OF MASERATI

The Quattroporte embodies the enduring and progressive spirit of Maserati as part of a story that dates back more than 100 years. It's a story of endurance. Of embracing challenge. Of going the distance and winning. And doing it all in audacious Italian style. Maserati officially opened for business in **1914** at No. 1 Via de' Pepoli in Bologna, but the wheels were in motion long before. In **1900**, Rodolfo Maserati's eldest son, Carlo, built a single-cylinder engine and fitted it to a bicycle. At just 17 years of age, Carlo raced his bicycle to victory in a punishing, long-distance rally in northern Italy. A short while later, the intrepid youngster designed another engine and fitted it to a wooden car chassis. This was, arguably, the world's first Maserati automobile.

The Maserati drive to innovate, and its passion for speed, made the transition into elite motorsport inevitable. It was a move that reaped countless rewards on the world stage. Here are just a few of the many historic successes: In **1926**, Alfieri Maserati drove the Maserati Tipo 26 to victory in its first-ever race—the Targa Florio in the mountains of Sicily. In **1939**, Wilbur Shaw won the Indianapolis 500 at the wheel of the Maserati "Boyle Special" 8 CTF at an average speed of more than 115 mph. Shaw repeated this feat the following year, making Maserati the only European manufacturer to win the Indianapolis 500 twice. In the late **1940s**, Maserati took a luxurious turn by creating the A6 1500 production grand tourer. This was built in our current home in Modena and featured sensuous Pininfarina coachwork. The convertible A6G Frua Spyder soon followed. Such power and performance had never been so beautifully packaged—opening up new worlds of long-distance possibilities in the process.

Since then, all Maserati production models have followed this unique formula, offering race-bred performance, captivating Italian design and all the luxuries and comfort you would expect from a prestigious grand tourer. Everything you would be right to expect from the Maserati Quattroporte.





E

A dark, moody photograph of a book's spine and cover, with the word "EXTERIORS" centered in white serif font. The book is positioned on the left side of the frame, with its spine and cover visible. The background is a deep, dark color, creating a high-contrast, dramatic effect. The text is in a classic, elegant serif typeface.

EXTERIORS

Formidable PRESENCE

Luxury, scale and space meet high performance in the Maserati Quattroporte. The supersedan eloquently expresses these qualities with its stately exterior lines and a dynamic tension that sets the heart racing.

The iconic Maserati Trident badge dominates the front grille of the Quattroporte. Inspired by the Alfieri concept, the fascia's deep-cut design presents an almost predatory, shark-like effect. The imposing presence is brought into even sharper focus by stylish Adaptive Full LED headlamps. Other striking details include triple air vents in the front fenders, frameless windows and the timeless Saetta logo on each C-pillar. At the rear, quad chrome-tipped tailpipes convey the Quattroporte's powerful ability to cross continents.



Sophisticated EXTERIOR COLORS

To enhance the eye-catching allure of the Quattroporte, Maserati offers a striking complement of paint finishes. Each color reflects a different side of the Maserati personality and captures the boldness and sophistication for which the Trident is renowned.



NERO (Solid Paint)

A black Maserati is synonymous with discipline, independence and strength. It makes a self-assured statement of power, control and authority.

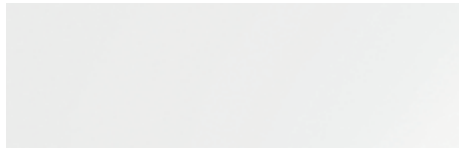

BIANCO (Solid Paint)

White is color at its purest. It is the color of perfection and new beginnings—a blank canvas on which to make your indelible mark.



GRIGIO (Metallic Paint)

Mature and responsible, grey imparts a sense of calm and composure. It conveys in an understated way the awesome power of a Maserati.



GRIGIO MARATEA (Metallescent Paint)

A special grey that is found in the rocks that form Maratea's Cave of Wonders, located along the stunning Tyrrhenian coastline in the south of Italy.



NERO RIBELLE (Mica Paint)

Ever the rebel—Maserati is unconventional, radical and unique, just like this deep and intense black, suggesting dark stone like Italian marble and granite.



BLU PASSIONE (Mica Paint)

A subtle blue for those with a passion for traveling long distances in comfort and style, who are mindful of Maserati's grand touring heritage.



ROSSO FOLGORE (Mica Paint)

A color inspired by Italy's legendary parachute regiment, known as the Folgore—known for their distinctive red berets.

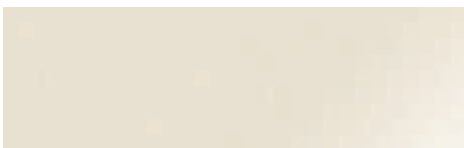

BIANCO ALPI (Tri-coat Paint)

A brilliant, shining white that reflects the purity of the snow-covered Italian Alps, world-renowned for their beauty and sporting allure.



BLU NOBILE (Tri-coat Paint)

This deep, dark blue with sparkling glass flakes glimmers in the sunlight. Evoking nature's tranquility, it complements the flowing lines of the Quattroporte.



INTERIORS

Unique VITALITY

The interior of the Maserati Quattroporte is a profoundly engaging place to be—on two levels. On the one hand, there is the awareness and the experience of massive performance. On the other, there is a sense of meticulously crafted comfort, technological convenience and peerless Italian style.

Among the Quattroporte's signature details is the Maserati Trident on the headrests and at the center of the steering wheel. The seats, upper dashboard and armrests are finished in fine leather. Touches of open-pore Radica wood provide a graceful accent. Both front seats feature 12-way power adjustment and heating, while a memory function reconfigures the driver's seat, steering wheel and door mirror positions according to his or her personalized settings.

Other highlights include the Maserati Touch Control Plus 8.4-inch infotainment system and, as standard, an air quality sensor—along with the option of exceptionally soft and durable Pieno Fiore natural leather and a choice of lavish interior trims. In the rear, the Quattroporte is appointed with 60/40 split-folding leather seats for three passengers, plus a power rear sunblind and power rear side sunblinds. In short, every personal need is met—then exceeded.





Elegant INTERIOR TRIMS

The purposeful ambience of the cabin is another aspect that sets Maserati apart. Lavish available interior trims add to the appeal of this sanctuary and further increase the options for personalization. Among them are these two premium selections.

HIGH-GLOSS CARBON FIBER TWILL

Developed to emphasize the sporty nature of Maserati, this sleek trim has a glossy top coat with a textured, three-dimensional look and adds further indulgence to the cabin. Every car is completely unique as the carbon pattern is real, ensuring that it will be slightly different every single time. The other beauty of carbon is its extraordinary natural strength, which prevents the trim from marking and protects the integrity of the Quattroporte interior.

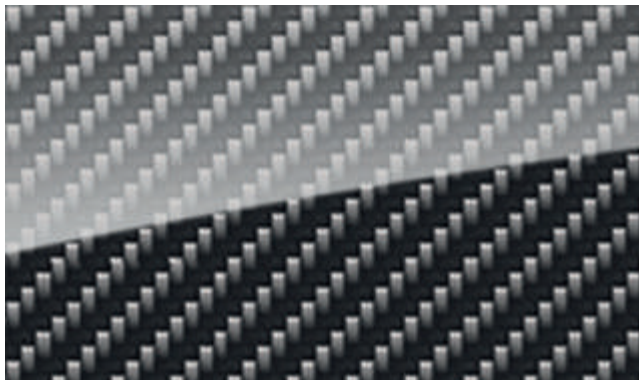

HIGH-GLOSS ROVERE VENEER

As with other select Maserati trims, this complex veneer took around a year to develop from original concept to finished product. It is a combination of three different woods layered and then crafted by artisans in Italy. The tree bearing the Rovere wood is the symbol of one of the most powerful Italian families, and it is the fine stripes and glossy top coat that give this trim its highly distinctive appearance.

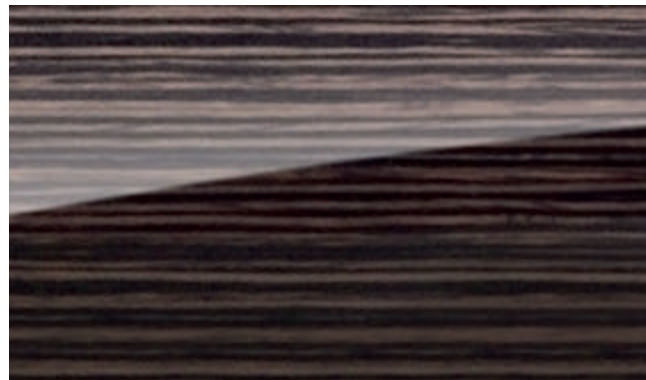

Pieno Fiore NATURAL LEATHER, BEYOND COMPARE

All leather is not created equal. Full-grain Pieno Fiore natural leather offers quality and durability, with an extraordinary softness to the touch.

An option for Quattroporte GranLusso and GranSport, Pieno Fiore leather—sourced especially for Maserati—is highly desirable for its subtle texture, aroma and ability to take on a beautiful patina over time.

This natural leather comes from the hide of bulls reared in the mountains of Northern Europe, at an altitude where there are few insects and no fences with spikes to blemish the pristine

hides. Available in black, red or tan—with a distinctive stitching pattern on the seats and door panels—Pieno Fiore is colored by a special process inside iroko hardwood barrels to bring out the most natural nuances in the finished product.

The raw material is crafted for six long weeks before the leather is ready for delivery to our production plant. It is this painstaking attention to detail that sets our leather—and our cars—apart.







GRAN DUO

Quattroporte GranLusso
LUXURY ON ANOTHER LEVEL



The Quattroporte can be specified to an even higher level of luxury with the GranLusso trim. Building on the appeal of the Quattroporte, GranLusso trim features a discreet front splitter, horizontal chrome bumper inserts, body-color side skirts, and the GranLusso badge on each front fender. Its luxurious stance is impressively punctuated by 20-inch silver Mercurio wheels and gloss black painted brake calipers with white Maserati script.







MASERATI

exclusively for

ERMENEGILDO ZEGNA

MASERATI

exclusively for

Mulberry

SILK BY ERMENEGILDO ZEGNA

The Quattroporte GranLusso is crafted for individuals who desire higher levels of luxury—which is why this model features a remarkable interior, styled and crafted by Ermenegildo Zegna, one of Italy's most celebrated fashion designer brands. The finest leathers are combined with Zegna's mulberry silk inserts on the seats, door panels, headliner and sun visors. The silk is embellished with a hand-stitched micro-chevron pattern, while the seating features a central silk insert with a macro-chevron weave. All this is available in three combinations of leather and silk with contrast stitching. Other GranLusso cabin refinements include a heated leather and wood steering wheel, wood trim, ventilated front seats and soft-close doors, as well as available four-zone climate control.

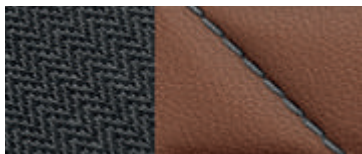

Tan Premium Leather/
Dark Grey Zegna Silk
with Light Grey
Contrast Stitching



Red Premium Leather/
Dark Grey Zegna Silk
with Light Grey
Contrast Stitching



Black Premium Leather/
Dark Grey Zegna Silk
with Light Grey
Contrast Stitching



CLASS ALL ITS OWN

Maserati refinement is a luxury not limited to front passengers. Perhaps the most indulgent of all positions is among the Executive Rear Seats of the Quattroporte. An option available exclusively with the GranLusso trim, the Executive Rear Seats are two individual heated and ventilated seats that recline and adjust fore and aft for supreme comfort. Between them, a rear center console features dual climate controls and switches for the rear and side sunblinds, as well as ventilated and illuminated storage with two cupholders. Stylish and inviting, the Executive Rear Seats are another way the Quattroporte brings grand touring to new heights of luxury.







GranLusso

Quattroporte GranSport

SHARPER SPORTING FOCUS

Individuals who seek a more sport-oriented Quattroporte will appreciate the GranSport trim. Highlights include boldly sculpted angles for the central-front and side intakes, aerodynamic lower front splitters, and a Piano Black center splitter and side inserts. The Quattroporte GTS GranSport increases the overt sporting demeanor with a sport front grille and side skirts.



The Quattroporte's striking profile includes GranSport badging and sweeping side skirts, while at the rear, a low-set diffuser is finished in Piano Black. Available 21-inch dark forged Atlante wheels—complemented by gloss red painted brake calipers with white Maserati script—express even greater sporting intent. The GranSport is also offered with the optional Full Carbon Fiber Kit. This features carbon fiber on the exterior door mirrors, door handles and B-pillar cover, as well as on the profile of the front bumper.





The ATHLETE WITHIN

The GranSport interior amplifies the Maserati Quattroporte's sporting character with a set of leather front and rear sport seats, firmly sculpted for optimal support during even the most spirited driving. A heated leather sport steering wheel and aluminum column-mounted paddle shifters offer precise control. High-gloss Piano Black wood trim on the dashboard and Inox sport pedals complete this inspiring picture. The optional Interior Carbon Fiber Package adds lightweight, tactile carbon fiber to the column-mounted paddle shifters, door sills and interior trim.



European model shown.







GranSport

Quattroporte GTS

THE POWER OF LUXURY

GTS stands for GranTurismo Sport, representing a level of performance experienced by only a fortunate few. This superior capability is clear for all to see on the Quattroporte GTS, alluded to in part by its menacing grille and side skirts. Unique to this version, they create an imposing presence on the road—and are an emphatic declaration of intent.

Although every Maserati road car achieves a perfect balance between performance and luxury, the power is even more pronounced with the GTS. This is due to its formidable 3.8-liter V8 engine, which effortlessly pushes the car to 62 mph in just 4.7 seconds, surging on to a top speed of 193 mph.

And whether you're accelerating away from a mountain bend or responding to an invitation from a long, open road, you will sense the force that comes from the massive power at your disposal—a not-so-subtle, and wholly unmistakable, attribute of the Quattroporte GTS.









E

ENGINES



Power PLAY

Delivering on all expectations, the engines powering the Quattroporte are designed by Maserati Powertrain and built at the Ferrari plant in Maranello.

Maserati vehicles are renowned for their ability to cover long distances at dynamic yet refined high speed. The Quattroporte upholds this tradition with a choice of two power plants. With the Quattroporte S and Quattroporte S Q4, that power comes from a 3.0-liter, twin-turbocharged V6 engine, and in the GTS from a mighty 3.8-liter, twin-turbocharged V8. Delivering a combination of inspiring power and business-like intelligence, the Quattroporte performs like a track-ready supercar, yet holds firm to its grand touring legacy.

When it comes to stirring emotion, nothing can match the unmistakable engine note of a Maserati. The Quattroporte combines a lightweight exhaust system with bypass valves to deliver visceral sound with maximum effect. With Sport mode active—which also sharpens the vehicle's handling parameters—the valves open to provide the shortest, highest-energy route for the exhaust gases. This transition results in optimized engine performance and the resonant, spine-tingling sound unique to cars that bear the Trident.

424 HP TWIN-TURBO V6

The Quattroporte S and S Q4 feature the most powerful version of Maserati's twin-turbocharged V6 engine. Maximum output is 424 hp delivered at 5,750 rpm. Peak torque of 428 lb-ft is on tap between 2,250 and 4,000 rpm, resulting in remarkable driving flexibility and performance. The Quattroporte S achieves the sprint from 0 to 62 mph in 5.0 seconds, while the S Q4 achieves it in 4.8 seconds. Both share a top speed of 179 mph.

523 HP TWIN-TURBO V8

The flagship Quattroporte GTS is fitted with a magnificent 3.8-liter, twin-turbocharged V8 engine that develops 523 hp from between 6,500 and 6,800 rpm. Torque is equally impressive at 524 lb-ft, available between 2,250 and 3,500 rpm in overboost mode. The GTS reaches 62 mph from a standing start in a breathtaking 4.7 seconds and continues to a top speed of 193 mph.





GT5 GranSport

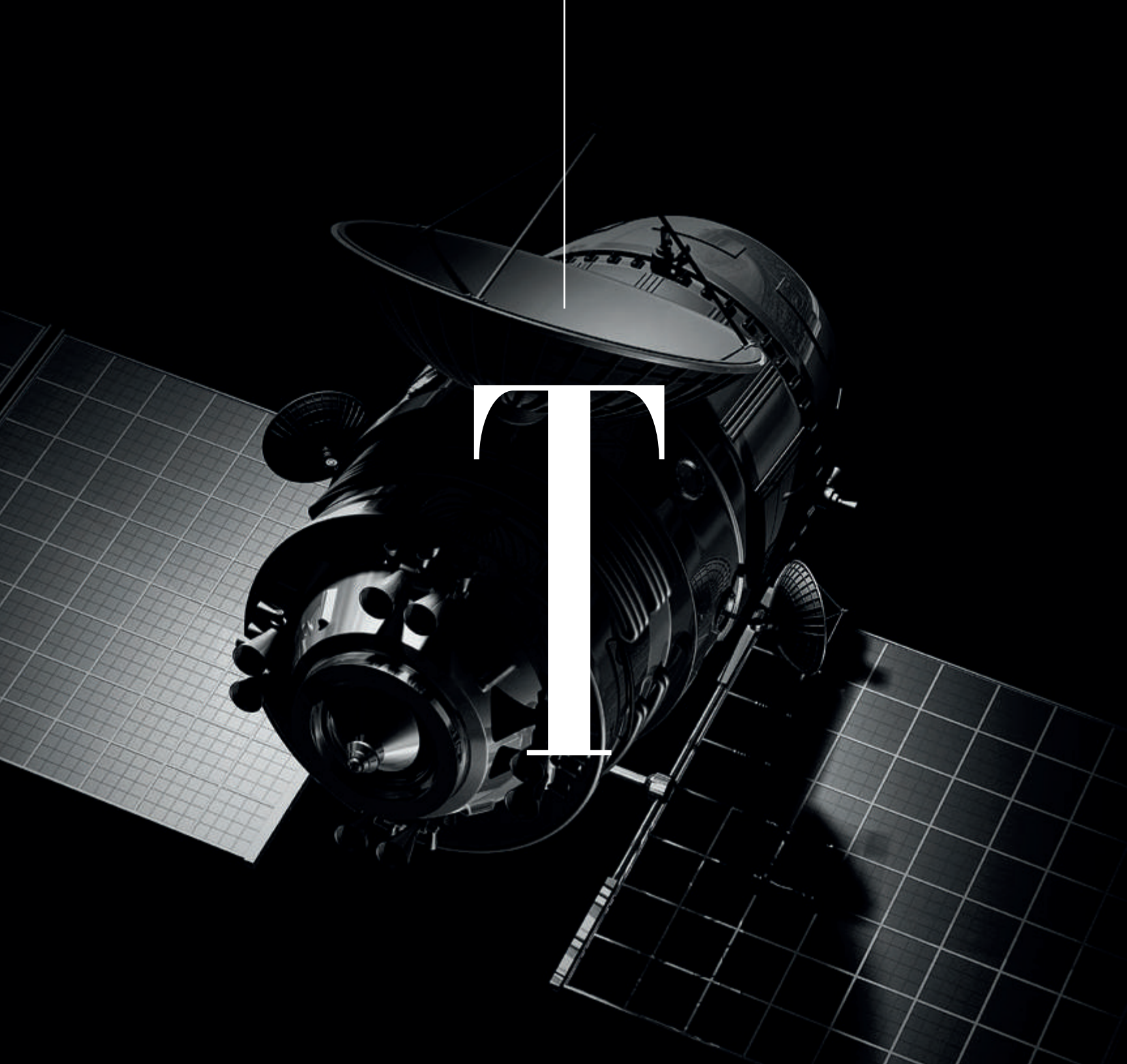

TECHNOLOGY



GranSport

One-to-one ENGAGEMENT

The Maserati Quattroporte features a sophisticated ZF eight-speed automatic transmission that puts a vast world of possibilities in the palm of your hand—and, if tempted, your fingertips.

With a two-lane gear lever featuring a dedicated Park button, the transmission uses auto-adaptive software to modify shift patterns according to driving style, for a truly one-to-one driving experience. Long, high-speed journeys are a chance to experience optimal efficiency and extra comfort thanks to the specially calibrated seventh and eighth gears. Power is routed through the transmission to the rear wheels of all versions via a standard mechanical Limited-Slip Differential (LSD). This ensures superb traction even in challenging situations. For maximum driver involvement, there are five operating modes, selected using the buttons next to the gear lever.

AUTO NORMAL MODE

This default mode provides smooth gearshifts at low revs to maximize ride comfort and optimize efficiency. When the system recognizes a sportier style of driving, upshifts automatically occur at higher engine speeds.

AUTO SPORT MODE

In this mode, gear changes are faster (less than 100 milliseconds) and occur at higher revs to create a near-seamless flow of power and a sportier driving experience. Auto Sport mode

also initiates overboost to access peak torque at far lower engine speed. Integrated Vehicle Control (IVC) adds to the excitement, giving the driver even more dynamic control.

MANUAL NORMAL MODE

This mode allows drivers to change gears using the lever on the center console or via the column-mounted paddle shifters. Upshifts occur automatically when approaching the rev limiter, and downshifts occur based on the recognized driving style.

MANUAL SPORT MODE

In Manual Sport, the driver is in full command of the transmission, and the driving experience is even more exhilarating. The overboost function activates for maximum performance; gear changes are quicker and sharper; and the engine can be pushed to the limit without the system intervening. The only automatic feature is downshifting if engine revs drop too low.

I.C.E. (INCREASED CONTROL & EFFICIENCY) MODE

This mode helps ensure better control in all weather conditions, with comfortable and quiet engine response and increased fuel efficiency.



GRIPPING EXPERIENCE

The long road ahead—with its twists, turns and occasional surprises—is there for the taking in the Maserati Quattroporte, thanks to a host of intelligent systems.

Q4 INTELLIGENT ALL-WHEEL-DRIVE SYSTEM

The Quattroporte S Q4, with its compact and lightweight Q4 intelligent all-wheel-drive system, is an ideal choice for drivers seeking the dynamic rewards of rear-wheel drive with the support of all-wheel traction. In normal conditions, the Q4 system sends all available torque to the rear wheels, for perfectly balanced Maserati driving dynamics and optimal efficiency. If traction is lost during fast cornering, sudden acceleration, or limited rear-axle grip, Q4 can alter the torque split from 100 percent rear-wheel drive to 50:50 between the front and rear wheels. In an imperceptible 150 milliseconds—less than the blink of an eye—the Quattroporte S Q4 intelligently applies power to maximize grip.

SKYHOOK PERFORMANCE SUSPENSION WITH ELECTRONIC DAMPING CONTROL

Standard on all Quattroporte versions is Maserati's Skyhook suspension system with continuous damping variation. Skyhook uses sensors to monitor the movement of each wheel and of the car's body to determine present road conditions and driving behavior. The system then instantly adjusts individual damper settings accordingly. Ride comfort is prioritized as standard, but pressing the Skyhook Sport Setting button on the Drive Mode control firms up the shock absorbers for more dynamic handling.

ELECTRIC POWER STEERING (EPS)

Every Quattroporte features EPS as standard, delivering handling response and road feel that is such an important part of our Maserati DNA. With EPS, the effort required for steering is adapted according to speed. When maneuvering in a tight spot, steering is lighter and easier to turn but has a weightier, more connected feel at high speeds. Powered directly by the engine, the system is particularly efficient and requires less maintenance, without need for a hydraulic pump or pressurized fluid. As an additional benefit, the electronic steering rack integrates with the vehicle's active Advanced Driving Assistance Systems such as Highway Assist¹, Lane Keeping Assist² and Active Blind Spot Assist.³

INTEGRATED VEHICLE CONTROL (IVC)

Driving dynamics are enhanced by IVC, which proactively addresses situations that could result in vehicle instability. The system works by selectively reducing engine torque and applying brake force to individual wheels as required. Out on the open road or through sweeping twists and turns, the result is increased control, greater driving enjoyment and potentially higher speeds.

¹ HAS requires the driver to keep his or her hands on the steering wheel at all times. This system is a driver's convenience system, not a substitute for active driver involvement. The driver must remain aware of traffic conditions and maintain control of the vehicle. ² This system is a driver's convenience system, not a substitute for active driver involvement. The driver must remain aware of traffic conditions and maintain control of the vehicle. ³ Always check visually for vehicles prior to changing lanes.



Jaguar Lusso

Innovation FOR A CONNECTED WORLD

A cutting-edge infotainment package puts the focus on intuitive engagement, real-world assistance and adaptable enjoyment.

The interior of the Quattroporte is built around a driver interface that is intuitive, uncluttered and simple to use. The instrument cluster features large analog gauges for the tachometer and speedometer, alongside a 7-inch TFT display. Major dynamic functions are incorporated into the buttons alongside the gearshift, while other on-board settings can be adjusted using the Maserati Touch Control Plus (MTC+) infotainment system at the center of the dashboard, or via the steering wheel controls for the 7-inch TFT display.

MASERATI TOUCH CONTROL PLUS (MTC+)

The 8.4-inch Maserati Touch Control Plus (MTC+) unit takes pride of place at the center of the Quattroporte dashboard. Using it is intuitive and easy, thanks to a minimalist layout and a highly responsive interface designed to help the driver maintain focus on the road ahead.

The MTC+ can be operated in three ways: via the multi-touchscreen interface, the rotary control on the central console or through voice commands. The system incorporates the car's radio, Bluetooth® and satellite navigation system, along with connections to external sources such as mobile phones, tablets and laptop computers.

Using the aux-in port, USB ports or the SD card reader, passengers can play music.¹ In addition, MTC+ controls many of the vehicle's other functions. The state-of-the-art system also supports Apple CarPlay® and Android Auto™ mirroring functions.^{2 3} Meanwhile, iPhone® users also benefit from Apple's Siri® personal assistant, allowing them to carry out tasks via voice commands.⁴

¹ For supported file formats, refer to the USB Port section of the owner's manual or DVD. ² Apple CarPlay®: Requires compatible iPhone®. See dealer for phone compatibility. Data plan rates apply. Vehicle user interface is a product of Apple®. Apple CarPlay is a trademark of Apple Inc. iPhone is a trademark of Apple Inc., registered in the US and other countries. Apple terms of use and other privacy statements apply. ³ To use Android Auto on your phone screen, you will need an Android phone running 5.0 (Lollipop) or higher and the Android Auto app. Android and Android Auto are trademarks of Google, LLC. ⁴ Requires an iPhone® with Siri®. Certain features are not available while the vehicle is in motion. iPhone must be within active cellular range. Customer's existing iPhone data rates apply to internet-supported features.



A large, white, serif capital letter 'S' is centered on a dark, monochromatic background. The background consists of several overlapping sheets of musical notation, including staves with notes, clefs, and other musical symbols, all rendered in a dark, almost black color. The lighting is dramatic, with the 'S' being the brightest element, and the musical notation appearing as dark silhouettes against a slightly lighter, textured background. A thin white vertical line is visible near the top center of the image, extending downwards towards the top of the 'S'.

S

THE SOUND OF QUALITY

Bowers & Wilkins

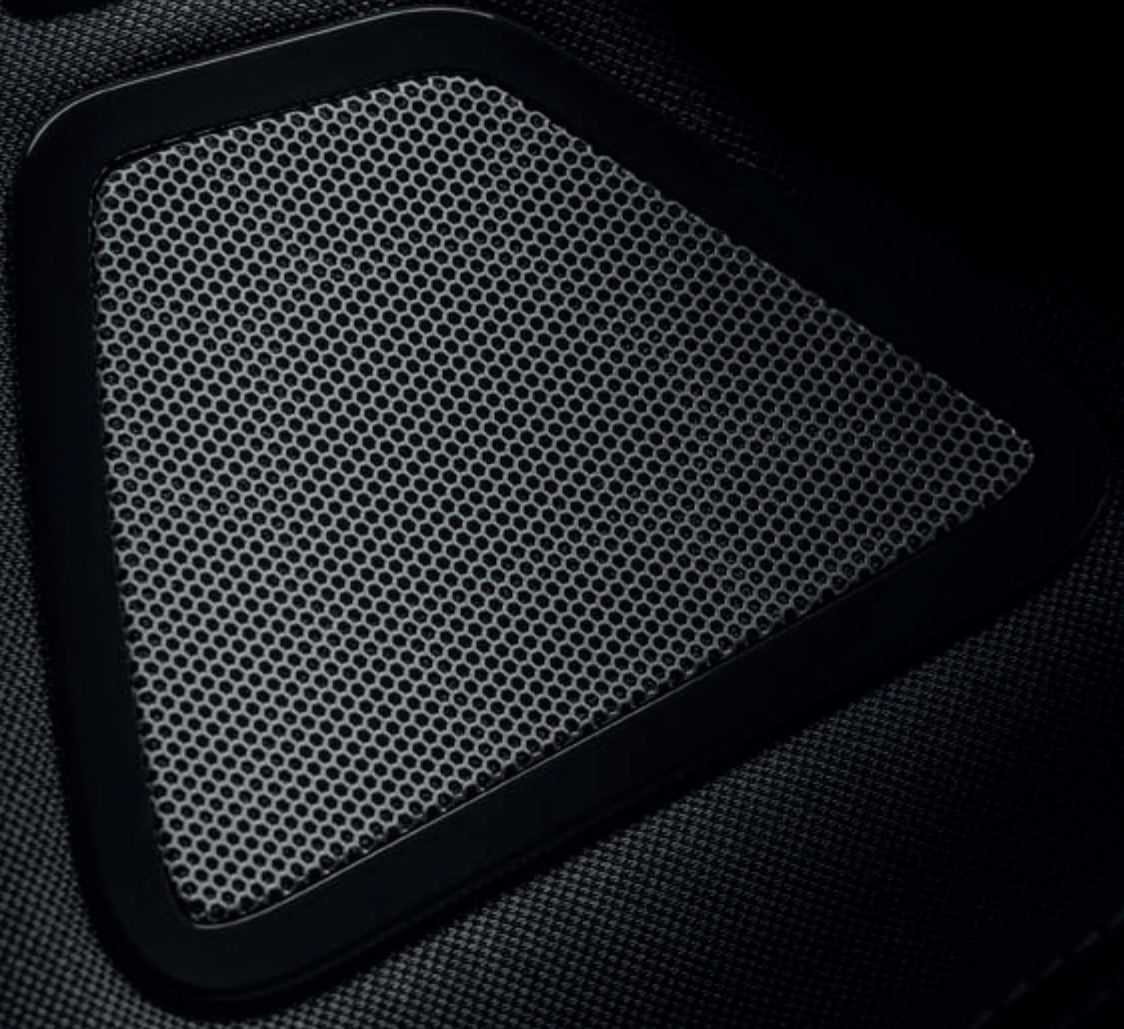

World-Class AUDIO ENTERTAINMENT

The Quattroporte is offered with a choice of two exceptional audio systems. The 900-watt, 10-speaker Harman Kardon Premium Audio System is fitted as standard, setting the bar at an impressively high level. True audio aficionados who seek the ultimate acoustics can upgrade to the 1,280-watt, 15-speaker Bowers & Wilkins Surround Sound System—simply the finest in sonic perfection.

HARMAN KARDON PREMIUM AUDIO SYSTEM

Fitted as standard, the Harman Kardon Premium Audio System offers an elevated level of audio refinement, with every facet tailored to complement the Quattroporte's stunning interior. To achieve this, Harman Kardon sound engineers worked very closely with the development team at Maserati. At the core of the system is a state-of-the-art, 900-watt amplifier, delivering rich and detailed sound quality via the radio, MP3 player, iPhone® or audio streaming device. A total of 12 independent channels are deployed for superb balance within the cabin. A high-performance subwoofer handles the low-end frequencies with ease, while the mid-range drivers and tweeters ensure that every instrument and every artist can be appreciated to the fullest. Ten high-powered speakers are carefully distributed throughout the interior to guarantee sublime sound for all on board.

BOWERS & WILKINS SURROUND SOUND SYSTEM

Bowers & Wilkins applies its 50-year history of extensive research and development in the field of psychoacoustics—the science of how people react emotionally to sound—to this magnificent audio system. Fifteen high-end speakers, with mid-range drivers and rear woofers made from aramid fibers, have been strategically built into the car's architecture, while a 1,280-watt amplifier ensures immersive sound. Advanced aluminum tweeters capture the faintest audio subtleties, while Rohacell® drivers assure deep, resounding bass. The system features QuantumLogic™ Surround Sound Technology, which digitally remodels signal streams and reconstructs the original recording of a musical piece. In addition, the Clari-Fi function automatically restores detail lost in digitally compressed music. The Quattroporte's Bowers & Wilkins system is compatible with most disc formats and features a built-in USB port for a smartphone or MP3 player. Alternatively, tracks can be streamed directly via either Bluetooth®, Apple CarPlay® or Android Auto™.^{1 2}

¹ Apple CarPlay®: Requires compatible iPhone®. See dealer for phone compatibility. Data plan rates apply. Vehicle user interface is a product of Apple®. Apple CarPlay is a trademark of Apple Inc. iPhone is a trademark of Apple Inc., registered in the US and other countries. Apple terms of use and other privacy statements apply. ² To use Android Auto on your phone screen, you will need an Android phone running 5.0 (Lollipop) or higher and the Android Auto app. Android and Android Auto are trademarks of Google, LLC.







SAFETY

68° 

91°out. E

4:50  FM 90.5

 68°

Controls



Lane Keeping Assist

VISUAL & HAPTIC



Auto High Beam Assist

Start & Stop 



Active Blind Spot Assist

VISUAL & ACOUSTIC



Privacy Lock

Surround Camera 



Forward Collision Warning

ACTIVE BRAKE: ON



Screen Off

Four Sunroofs 



Traffic Sign Assist

BLINKING: OFF

Settings 

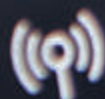

Radio



Media



Controls



Climate



Nav



Phone

AUTO



Advanced DRIVING ASSISTANCE SYSTEMS

The Quattroporte is equipped as standard with a comprehensive range of Advanced Driving Assistance Systems. These innovative safety features offer greater peace of mind, whether you're on a continent-crossing grand tour or dashing across town.

HIGHWAY ASSIST SYSTEM (HAS)

Combining the virtues of Adaptive Cruise Control with Stop & Go and Lane Keeping Assist, HAS makes life easier while driving on highways, achieving Level 2 semi-autonomous driving.¹ Using information picked up from a digital camera mounted behind the rear-view mirror and a radar system in the front grille, HAS automatically keeps the vehicle centered in its lane, at a preselected speed and at a chosen distance from the vehicle ahead, and will decelerate the Quattroporte as traffic conditions dictate. To help ensure safety, HAS requires the driver to keep his or her hands on the steering wheel at all times.

TRAFFIC SIGN RECOGNITION

While monitoring two types of signage—speed limits and temporary speed limits due to conditions such as heavy rain—the Traffic Sign Recognition system displays updated signs digitally in the gauge cluster.² The system works with a digital camera mounted behind the rear-view mirror in conjunction with navigation system data.

LANE DEPARTURE WARNING

Using a camera in the rear-view mirror to monitor road markings ahead, this system helps drivers keep the vehicle in the chosen lane on highways and main roads.³ This system helps reduce lane drift and the possibility of lateral collisions by warning when the vehicle crosses lane markings without the turn signal activated. Activation of the turn indicator overrides the system.

LANE KEEPING ASSIST (LKA)

This system provides valuable support if the driver is about to unintentionally leave a lane.³ A digital camera behind the rear-view mirror monitors road markings to communicate the status of the course ahead. The instrument panel display shows the specific status: White lines on either side of the vehicle image indicate that it is safely in the lane. One yellow line indicates that the Quattroporte is moving off-center, right or left. One flashing yellow line warns of lane departure. At that point, when the Visual & Haptic box is selected in the touchscreen display, if the Quattroporte appears to be moving out of the lane unintentionally, LKA actively steps in with corrective steering torque. Activation of the turn indicator overrides the system.

ACTIVE BLIND SPOT ASSIST

The Blind Spot Alert continually assesses the space between the Quattroporte and nearby vehicles by scanning blind spots on either side of the vehicle with radar-based sensors.⁴ When a vehicle enters one of these areas, a warning triangle appears in the door mirrors to alert the driver of its presence. If the turning indicator is activated to change lanes, a warning is sounded. Active Blind Spot Assist increases the level of protection.⁴ Along with a visual alert in the door mirrors and an acoustic warning, it also intervenes with steering torque if the driver starts to change lanes while a vehicle is in the blind spot.

¹HAS requires the driver to keep his or her hands on the steering wheel at all times. This system is a driver's convenience system, not a substitute for active driver involvement. The driver must remain aware of traffic conditions and maintain control of the vehicle. ²Traffic Sign Recognition is not a substitute for safe and attentive driving. Factors including weather and condition of the traffic sign can impact recognition and display of the sign. Always check traffic signs visually while driving. ³This system is a driver's convenience system, not a substitute for active driver involvement. The driver must remain aware of traffic conditions and maintain control of the vehicle. ⁴Always check visually for vehicles prior to changing lanes.



GranSport

SURROUND VIEW CAMERA

This system provides a clear 360-degree view around the vehicle to assist with parking and highlighting otherwise hidden obstructions.¹ Cameras beneath the door mirrors, plus front and rear cameras, capture images shown on the center display screen.

ADAPTIVE CRUISE CONTROL WITH STOP & GO

Adaptive Cruise Control constantly monitors the vehicle ahead, maintaining a pre-set distance.² With the Stop & Go function, the vehicle will also adjust to the speed of the vehicle in front until it comes to a complete stop.

FORWARD COLLISION WARNING PLUS

This system, in combination with Adaptive Cruise Control, monitors vehicles and pedestrians ahead and warns if the approach could result in a rear-end collision.³ This is linked to the Advanced Brake Assist System, which provides additional braking during an emergency stop. If the warning does not prompt any action from the driver, the Autonomous Emergency Braking System automatically applies the brakes to reduce vehicle speed.

REAR CROSS PATH FUNCTION

This system emits a warning when an unseen vehicle is approaching, from the right or left, while the driver is reversing out of a parking space.¹ (Available only in combination with Blind Spot Alert.)

FRONT AND REAR PARKING SENSORS AND REAR-VIEW CAMERA

To assist with maneuvering in tight spaces, the Quattroporte comes equipped with parking sensors in the front and rear bumpers.⁴ Beeping noises increase in frequency as the obstacle approaches. Additionally, the instrument panel TFT display shows the car surrounded by symbols in green, yellow or red, depending on the remaining distance. In addition, the rear-view camera shows what is behind the car on the infotainment screen. Dynamic grid lines illustrate the maximum width of the vehicle and its projected path, based on the steering angle of the front wheels.

¹ Always check entire surroundings visually before proceeding. ² This system is a driver's convenience system, not a substitute for active driver involvement. The driver must remain aware of traffic conditions and be prepared to use the brakes to avoid collisions. ³ This system is an alert system for the front of the vehicle. It is not a substitute for active driver involvement. The driver must remain aware of traffic conditions and be prepared to use brakes to avoid collisions. ⁴ Always look before proceeding. An electronic drive aid is not a substitute for conscientious driving. Always be aware of your surroundings.



Comprehensive SAFETY

Maserati engineers have made safety a top priority when designing the Quattroporte, providing mile after mile of high-powered driving excitement, luxury and peace of mind.

MASERATI STABILITY PROGRAM (MSP)

Developed under extreme testing conditions, the Maserati Stability Program (MSP) employs an array of sensors to constantly monitor driving conditions, while utilizing a host of safety and performance systems to maintain handling and grip.* If, for instance, a skid is detected, MSP selectively reduces engine torque and can activate the brakes with finely varied inputs to help restore stability within milliseconds.

The MSP system also works in conjunction with features like Anti-Slip Regulation (ASR), which reduces wheel spin and improves traction, and engine brake torque control (MSR), which prevents the wheels from locking during sudden downshifts. Additionally, the Anti-Lock Braking System (ABS) reduces wheel lockup and Electronic Brakeforce Distribution

(EBD) distributes brake force evenly between the front and rear axles. Further support is provided by the Brake Assistance System (BAS), which responds to emergency stops by boosting pressure in the hydraulic circuit to maximize stopping power. The Hill Holder function keeps the vehicle from rolling backward when the driver sets off on an uphill slope.

TIRE PRESSURE MONITORING SYSTEM (TPMS)

This standard system continuously monitors tire pressure using a sensor integrated with the tire valve, which can be read on the dashboard display. In the case of a puncture or a change in tire pressure, the system notifies the driver with visual and acoustic warnings.

* Always drive carefully, consistent with conditions. Always wear your seat belt and obey traffic laws.



ADAPTIVE FULL LED HEADLAMPS WITH AUTOMATIC HIGH BEAM ASSIST

The Quattroporte is fitted with Adaptive Full LED headlamps that even further sharpen the striking Maserati look, significantly improve visibility and lower energy usage. With 15 LEDs operating at full beam, these headlights offer a greater field of vision than traditional halogen lights. Road illumination extends, and bulb longevity is roughly doubled.

Automatic High Beam Assist provides increased forward lighting at night by automating high beam control through the use of a forward-facing digital camera located behind the rear-view mirror. This camera detects environmental luminosity, the headlamps of oncoming vehicles and the tail lamps of proceeding vehicles in the front area. In these cases, the system automatically switches from high beams to low beams until the approaching vehicle is out of view.

ADAPTIVE DRIVING BEAM (ADB)

This system automatically adjusts the width and depth of the headlamp beams, giving maximum lighting effectiveness and optimal safety. This is made possible by a camera mounted in the rear-view mirror and sensors that monitor several different parameters, including the steering wheel position, the car's speed and driving behavior. ADB comes on automatically when driving in bad weather, on highways or in town.

AIRBAGS AND ACTIVE HEADRESTS

The Quattroporte is equipped with six airbags. Two front airbags, both dual-stage, offer added protection for the driver and front passenger in the event of collision, while further protection is provided by side and window airbags.* There are also active headrests in the front seats. These automatically move in closer to the occupants' heads to reduce the risk of whiplash injury.

* Always sit properly in designated seating positions with seat belts securely fastened at all times.

Quattroporte

TECHNICAL SPECIFICATIONS

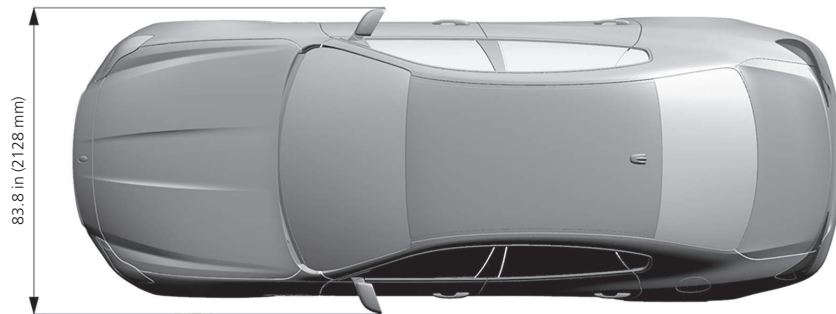
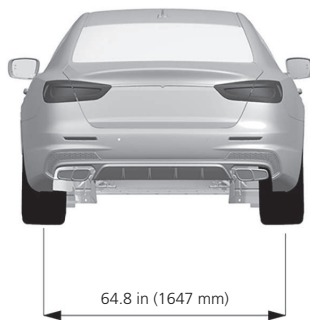
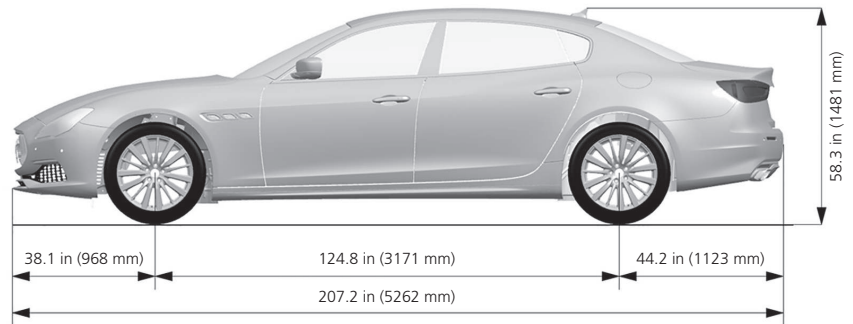
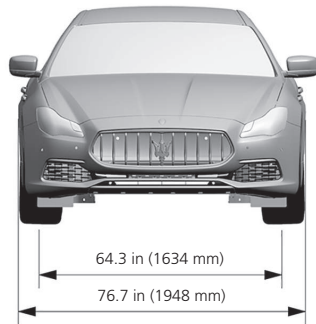

DIMENSIONS AND WEIGHTS	QUATTROPORTE S	QUATTROPORTE S Q4	QUATTROPORTE GTS
Length	207.2 in (5262 mm)	207.2 in (5262 mm)	207.2 in (5262 mm)
Width (with side mirrors)	83.8 in (2128 mm)	83.8 in (2128 mm)	83.8 in (2128 mm)
Width (without side mirrors)	76.7 in (1948 mm)	76.7 in (1948 mm)	76.7 in (1948 mm)
Height	58.3 in (1481 mm)	58.3 in (1481 mm)	58.3 in (1481 mm)
Wheelbase	124.8 in (3171 mm)	124.8 in (3171 mm)	124.8 in (3171 mm)
Front track	64.3 in (1634 mm)	64.3 in (1634 mm)	64.3 in (1634 mm)
Rear track	64.8 in (1647 mm)	64.8 in (1647 mm)	64.8 in (1647 mm)
Front overhang	38.1 in (968 mm)	38.1 in (968 mm)	38.1 in (968 mm)
Rear overhang	44.2 in (1123 mm)	44.2 in (1123 mm)	44.2 in (1123 mm)
Turning circle	38.7 ft	38.7 ft	38.7 ft
Trunk capacity	18.7 cu ft	18.7 cu ft	18.7 cu ft
Fuel tank capacity	21.1 g	21.1 g	21.1 g
Curb weight	4,101 lbs	4,233 lbs	4,189 lbs
ENGINE			
Number of cylinders and layout	V6 60°	V6 60°	V8 90°
Displacement	3.0 L (2979 cm ³)	3.0 L (2979 cm ³)	3.8 L (3799 cm ³)
Bore	86.5 mm	86.5 mm	86.5 mm
Stroke	84.5 mm	84.5 mm	80.8 mm
Compression ratio	9.7:1	9.7:1	9.5:1
Max. power output	424 hp	424 hp	523 hp
Engine speed at max. power output	5,750 rpm	5,750 rpm	6,500-6,800 rpm
Peak torque	428 lb-ft	428 lb-ft	479 lb-ft
Engine speed at peak torque	2,250-4,000 rpm	2,250-4,000 rpm	2,000-4,000 rpm
TRANSMISSION			
Transmission	Automatic 8 gears	Automatic 8 gears	Automatic 8 gears
PERFORMANCE*			
Maximum speed	179 mph	179 mph	193 mph
Acceleration 0-62 mph (0-100 km/h)	5.0 s	4.8 s	4.7 s
Stopping distance 62-0 mph (100-0 km/h)	116.5 ft	116.5 ft	111.5 ft
Fuel consumption (combined)**	19 mpg	18 mpg	17 mpg
Fuel consumption (city)**	17 mpg	16 mpg	15 mpg
Fuel consumption (highway)**	24 mpg	23 mpg	22 mpg

* Maserati SpA test results. Actual acceleration results may vary, depending upon specification of vehicle, road and environmental conditions, testing procedures and driving style.

** EPA estimated mpg. Actual mileage may vary.



THE WORLD OF MASERATI

BECOME A MASTER OF DRIVING

MASTER MASERATI DRIVING COURSES

Driving a Maserati on the open road is one of life's most exhilarating experiences. With a Master Maserati driving course, you can quickly find out what happens when you swap the joys of the highway for the intensity of the track or the challenges of a tough off-road circuit.

Master Maserati courses give you free rein to explore the seemingly endless dynamic potential of the entire Maserati model range. They also offer two rare and truly extraordinary opportunities—taking personal charge of the awe-inspiring GranTurismo GT4 racer and experiencing it with a GT world champion at the wheel.

As a Master Maserati driver, you'll discover how all Maserati cars—with their racing DNA—are built to bring out the very best in you as you pursue ever-faster lap times or tackle difficult terrain.

But you won't be going it alone. We provide tailored one-to-one instruction from championship-winning drivers who coach from the passenger seat as you drive, providing a level of personal attention that promises both immersive enjoyment and accelerated learning. The support of advanced technology, such as telemetry and video analysis, helps to further fine-tune your skills.

Master Maserati courses are held at the Varano de' Melegari (Parma) circuit, a track with first-class safety standards and superb on- and off-road facilities nestled in the beautiful Italian countryside.

YOUR INSTRUCTORS

Our expert instructors are international drivers with firsthand experience in elite racing categories such as Formula 1, the World Endurance Championship and the World Rally Championship. The members of the coaching team are all Italian, and they've worked at Master Maserati for many years, combining training at Varano with their own motorsport careers. All in all, including our driving experts, the staff consists of more than 50 people, led by Andrea de Adamich, a highly respected figure in motorsport.

PRACTICE

START YOUR ENGINES AND GET READY FOR YOUR FIRST RIDE INTO THE MASERATI WORLD

The journey to Maserati mastery starts now. Imagine a Formula 1 practice session and then put yourself in the driver's seat. This is, essentially, what happens here. After you've picked up the fundamentals of track driving through one-to-one expert guidance, you'll be out there on the track—enjoying the immediate, exhilarating experience of exploring the performance limits of the Quattroporte, Ghibli, Levante, GranTurismo and GranTurismo Convertible. It's an experience that will make you a considerably better driver and eager for more excitement in the future. You'll also be ready to take the next step up—to Qualifying.

QUALIFYING

MASTER THE ART OF SPEED BEHIND THE WHEEL OF A MASERATI

Progression to the Qualifying stage means raising the intensity in the GranTurismo, Ghibli, Quattroporte and Levante. Just as you would in a qualifying session, you'll be pushing the limits, making mistakes, fixing them—and getting faster—as you master the art of speed in your Maserati. And, of course, your Master Maserati driving expert will be right there by your side, passing on championship-winning knowledge and insight. At this level, we introduce detailed video analysis and vital insights from racing telemetry that will help you fine-tune your skills. These techniques often lead to major improvements in your driving, which you will be eager to build on in the courses to come.

RACE

EXPERIENCE THE RAW EXCITEMENT OF BEING A MASERATI RACING DRIVER—IN THE BREATHTAKING GT4

In this one-day course, you'll be driving a full-blooded racer—the GT4. Before you're strapped into that six-point harness, you will get to know the vehicle inside and out. Then, after expert coaching, you'll be ready to hit the track and discover what the GT4 car really can do—and how far you can take it. There will also be timed, competitive driving. As in professional motorsport, you'll be supported by an expert team, from seasoned mechanics to telemetry experts.

CHAMPIONSHIP

EXPERIENCE AN EXCEPTIONAL CAR: THE GRANTURISMO MC GT4

This is the elite, two-day Championship experience, complete with your own paddock team, personal coach and, naturally, cutting-edge telemetry. You'll even have access to the Ferrari F1 team's MedEx physical therapy specialists. This is essential support, because you'll be driving the awe-inspiring GranTurismo GT4. And that means G-forces far beyond anything your body may have experienced before. You'll also experience hot laps driven by none other than four-time world champion Andrea Bertolini in this iconic racing machine.

RALLY POWER STAGE

DISCOVER AND MASTER THE MASERATI OF SUVs—ON ALL TERRAINS

Get ready to ramp things up, on and off the road. This full-day master class is mainly focused on the remarkably capable Maserati Levante, given its authentic all-terrain credentials. All other Maserati models also feature in this experience, however, and you'll discover how a combination of individual skills and progressive technology keeps you perfectly composed on low-grip surfaces and even the most challenging inclines. When you do venture into the Varano circuit's private nature reserve, the Levante takes center stage. With close guidance from your instructor, you'll take on a host of tasks that showcase the SUV's abilities, while bringing out the best of you as a driver.

MASTER INCENTIVE

TEAM BUILDING, OR EVEN A SPECIAL THANK YOU, DOESN'T GET MORE EXHILARATING THAN THIS

Nothing bonds a team like the exhilaration and spirit of a Master Maserati driving experience. What's more, we can tailor any program to suit the interests and aims of your business or team, and we welcome groups of any size for the number of driving days preferred. For instance, we can provide instruction on the basics of track driving or how to become a racing driver. We offer guidance from expert drivers, one-to-one coaching, video, telemetry recording and the full support of a crew. The driving can also be combined with cultural programs and activities, including a visit to the Panini Motor Museum in Modena, culinary experiences and a Maserati factory tour. For your added convenience, we offer a range of supplementary services, such as organizing hotels and airport transfers.

ARE YOU READY TO MASTER MASERATI?

For information on availability, pricing, timing and registration, please contact us at info@mastermaserati.it.

THE WORLD OF THE TRIDENT

FACTORY TOUR*

Learn about the skills involved in producing some of the world's finest high-performance automobiles by visiting the Maserati factory in Modena. Our 90-minute factory tour includes a welcome reception in our showroom and a presentation of more than 100 years of Maserati heritage. The tour also includes a guided walk around the assembly line, an opportunity to view the finished cars and a chance to browse the Maserati store.

SHOWROOM TOUR (MODENA ONLY)

For those short on time, we offer a 30-minute guided showroom tour. After a welcome reception and a presentation of our illustrious heritage, your guide will take you through the entire model range on display in the Modena showroom. Commentary can be provided in English, Italian, German, French or Spanish. It is also possible to combine the Maserati Factory Tour with a Master Maserati driving course and experience the entire World of Maserati. For reservations or more information, please email factorytour@maserati.com.

FACTORY DELIVERY EXPERIENCE

The first drive in your new Maserati is one to savor—and there's no better starting line than the birthplace of the car itself. Your event begins at the Maserati showroom, where, after a warm welcome from a Maserati representative—including coffee and drinks—you can take a 90-minute tour of the production line, accompanied by a specialist guide and photographer. After the tour, it's time for the unveiling of your car, where you will receive a thorough explanation of its features and sign the documentation to officially take ownership of your new Maserati. Before we bid you farewell, our photographer will capture the occasion with pictures at the Maserati facilities. Please allow between two-and-a-half to three hours for the full experience, including the factory tour.

Delivery locations

All models can be delivered to Modena.

How to book

You can request a factory delivery through your official Maserati dealer when you place your car order. Approximately one month prior to delivery, we will arrange a date for your Factory Delivery Experience.

*Tours are arranged by appointment only and can be booked through dealers all over the world.

MASERATI COLLECTION

The Maserati Collection of branded merchandise is specially designed for those with a passion for all things Maserati. Maserati Collection items are available from all official Maserati dealers and the Maserati showroom stores in Modena and Grugliasco. Alternatively, the items can be purchased online at maseratistore.com and delivered directly to you.

MASERATI CLUB

Joining a Maserati Club means sharing insights and exciting experiences with other Maserati owners—and being invited to take part in special motoring events all over the world. Drivers of Maserati automobiles from every era can enjoy the pleasure of driving their cars in a calendar of events created especially for club members. Our Maserati Clubs provide the link between the company's past, present and future. Visit maseraticlub.com for more information.

MASERATI GENUINE ACCESSORIES

Maserati Genuine Accessories for the Quattroporte offer the perfect combination of design and functionality. The attention to detail, style and quality of each accessory reveal the very essence of the Maserati brand. The Quattroporte accessories range includes special wheel rims and Maserati Genuine Tires. Maserati-branded transport accessories include the Luggage Compartment Mat and Foldable Box, as well as the Ski & Snowboard Bag. Added to the range are care and safety accessories, including stylish car covers, which ensure the Quattroporte is perfectly protected. You can discover the full range of Maserati Genuine Accessories in the dedicated brochure, on our official website at maserati.com, or through an official Maserati dealer or service center.

MASERATI CLASSICHE

Created for enthusiasts and owners of classic Maserati automobiles, Maserati Classiche is an organization dedicated to those who wish to engage with the marque's glorious past. Maserati Classiche includes an important historical document service dedicated to current owners of classic Maserati cars, a series of celebratory products, clothing, scale models and much more. You can find all the latest items on maserati.com in the Maserati Classic section. For more information, email maserati.classiche@maserati.com.

NORTH AMERICA

USA
Canada

CENTRAL/SOUTH AMERICA

Argentina
Brazil
Chile
Colombia
Costa Rica
Dominican Republic
Ecuador
Guatemala
Mexico
Panama
Perù
Puerto Rico
Uruguay

EUROPE

Andorra
Austria
Belarus
Belgium
Bulgaria
Cyprus
Czech Republic
Denmark
Estonia
France & Monaco
Germany
Greece
Hungary
Israel
Italy
Kazakhstan
Lithuania
Luxembourg
Netherlands
Norway
Poland
Portugal
Romania
Russia
Slovakia
Slovenia
Spain
Sweden
Switzerland
Turkey
Ukraine
United Kingdom

AFRICA & MIDDLE EAST

Bahrain
Egypt
Jordan
Kuwait
Lebanon
Morocco
Oman
Qatar
Saudi Arabia
South Africa
United Arab Emirates

ASIA/OCEANIA

Australia
China
Hong Kong
India
Indonesia
Japan
Malaysia
New Zealand
Philippines
Singapore
South Korea
Taiwan
Thailand
Vietnam



MASERATI CONTACT CENTER: 877.MY.MASERATI | mymaserati@maserati.com
24-HOUR ROADSIDE ASSISTANCE WITHIN THE U.S. AND CANADA: 888.371.1802





The illustrations and texts contained in this brochure are based on information available at the time of production and do not contain a description of specific characteristics of the car by the Manufacturer. Some models, equipment and accessories may not be available or may become available only after the automobile's launch on the market. Maserati reserves the right to modify colors, designs and technical features at any time and without advance notice. Official Maserati dealers will be glad to provide further details and updates in this regard. © 2020 Maserati North America, Inc. All rights reserved. Maserati and the Trident logo are registered trademarks of Maserati SpA. Maserati urges you to obey all posted speed limits.



MASERATIUSA.COM
MASERATI NORTH AMERICA, INC. | 1 CHRYSLER DRIVE | AUBURN HILLS, MI 48326