

## Some of the things that make the Toyota Celica ST go.

The ratio of engine power to total car weight determines whether a vehicle moves or whether it lumbers. The Toyota Celica moves swiftly, easily. Swiftly, because we put a high output, 108hp engine in a lightweight, 2,270lb. body. Easily, because Celica is engineered to handle like a sports car. Up front, there's an independent coil suspension system with strut type lower wishbones, deep telescopic shocks, two short-strut torsion bars, and a special anti-sway bar for better cornering.

And in back, there's a completely new rear suspension system with four longitudinal links and a lateral track bar as well as heavy coils with deep telescopic shocks to give you the kind of riding comfort and road stability you'd expect in a much higher-priced car. Celica's recirculating-ball type steering with a variable gear ratio is designed for precise, sensitive steering. All of which allows Celica to turn a circle in only 31.5 feet. It also means that anyone able to turn on the ignition can turn the sharpest corners just as easily. (Well, almost.)

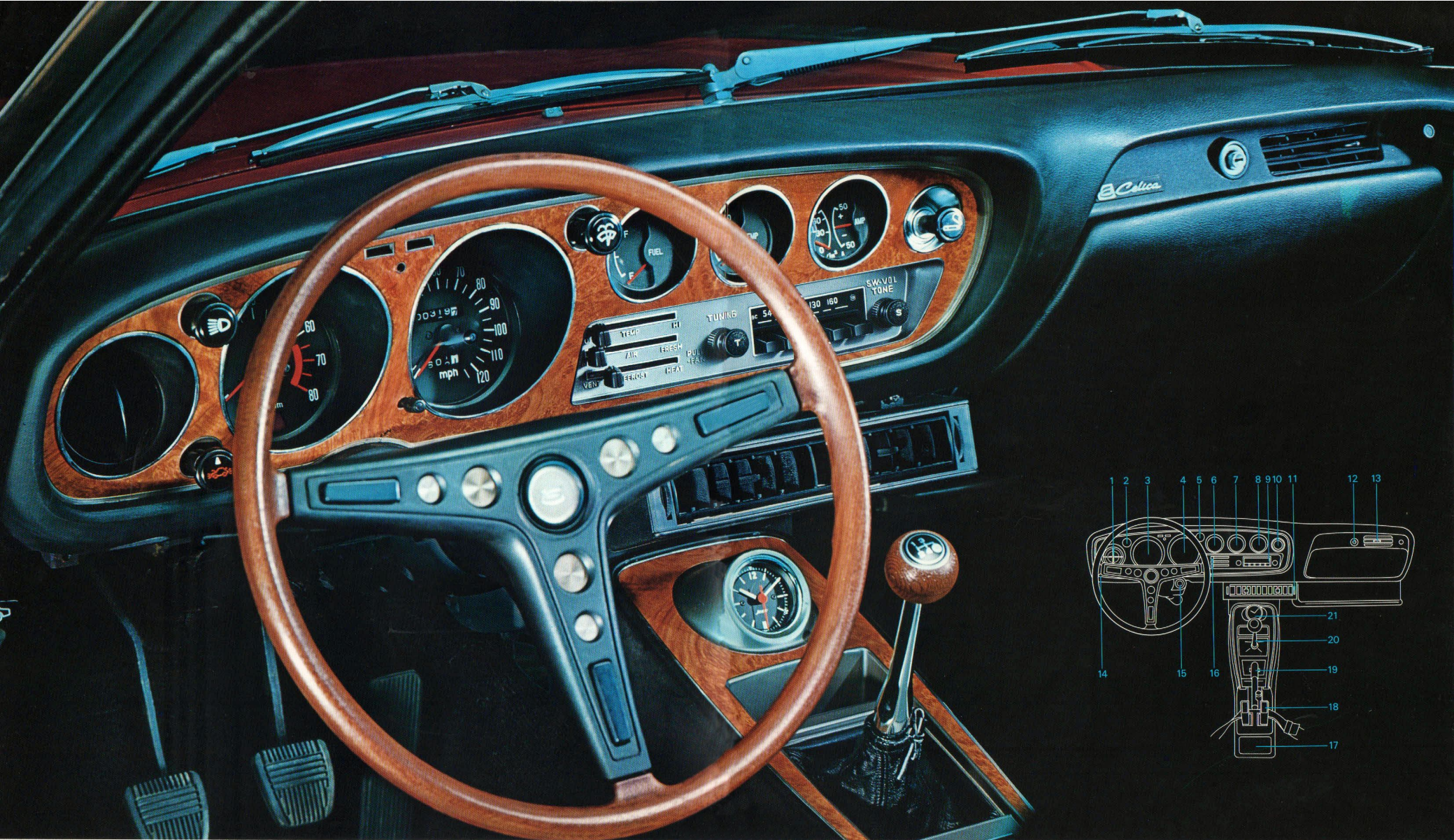

## Inside Toyota Celica ST.

Toyota set out to prove that the Celica ST could be just as sporty inside as out. So they trimmed the woodgrained dash with deeply-padded, glare-free materials. Mounted a short-throw 4-speed stick on a woodgrained console. And added a 3-spoke, woodgrained steering wheel, 8000rpm tachometer, electric clock, push-button AM radio, and wall-to-wall nylon carpeting as standard equipment. And that's only part of the story.

The numbers in the above picture correspond to the numbers below. (Everything is standard equipment unless otherwise specified.)

1. Adjustable interior ventilation louver (left side).
2. Headlight switch.
3. Tachometer.
4. Speedometer and resettable mileage meter.
5. Windshield wiper/washer switch.
6. Fuel gauge.
7. Temperature gauge.
8. Oil/amp gauge.
9. Push-button AM radio (standard) and optional 8-track stereo tape deck.
10. Cigarette lighter.
11. Heater

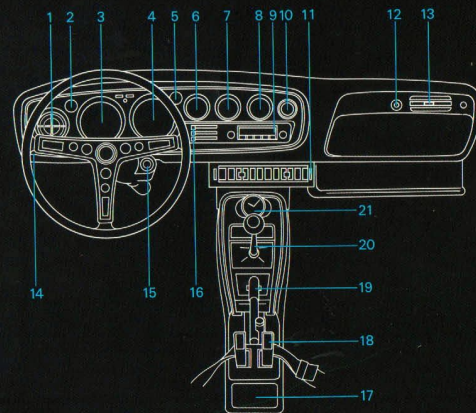

12. Locking glove box (includes can of touch-up paint.)
13. Interior ventilation louver (right side).
14. 4-way hazard warning light switch.
15. Anti-theft steering column lock and ignition key warning buzzer.
16. Heater/defroster controls.
17. Rear passenger's ashtray.
18. Seat belt slots (keeps them out of the way when they're not in use).
19. Hand brake.
20. Woodgrained stick shift.
21. Electric clock with sweep second hand and time ring.

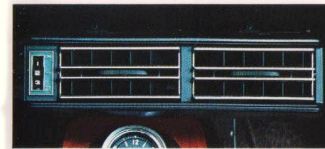
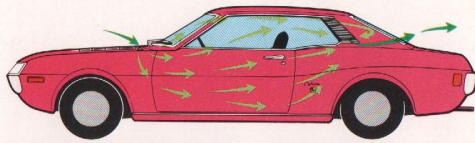

Factory installed air conditioner (optional).

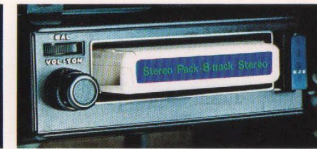

8-track stereo tape deck (optional).

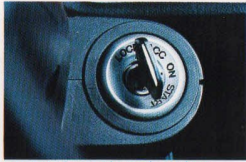

Anti-theft steering column lock.



Flo-thru ventilation system (standard).

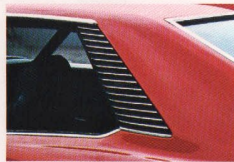

Heater.



Heater/defroster controls and AM radio.



The inside of the Celica ST looks just as sporty as the outside.



Rear seats with 2-point safety belts (standard).

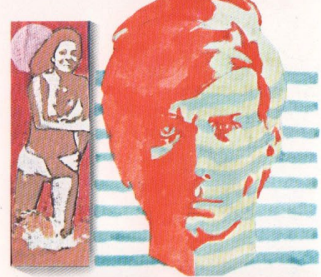

Doors open in 2 stages.

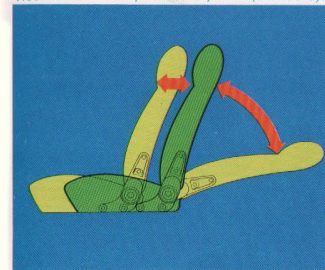

Fully reclining front buckets.



Seat pocket (standard).

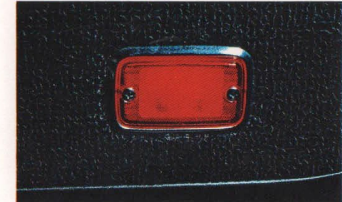

Courtesy door lights (standard).

The size of a car's outside (bumper-to-bumper) doesn't necessarily have anything to do with the length of its interior. Celica is a prime example. It has more space inside than cars that are much bigger outside. Celica's passenger compartment stretches 64.0 inches from the dash to the back of the rear seat. And measures a comfortable 52.4 inches across. And Celica's body is tightly sealed to keep dirt, rain and

noise outside where it belongs. It's also fully undercoated with a special sealant to prevent rust and corrosion. Because of our flo-thru ventilation system and booster fan, you get all the air you need. Even when Celica is standing still with the windows rolled up, fresh air flows in and out. Four other nice things about Celica are the seats. Fully reclining, multi-angle buckets up front that adjust 6.3 inches fore and aft. Deep-contoured, roomy ones in back.



Sporty hood air vents.

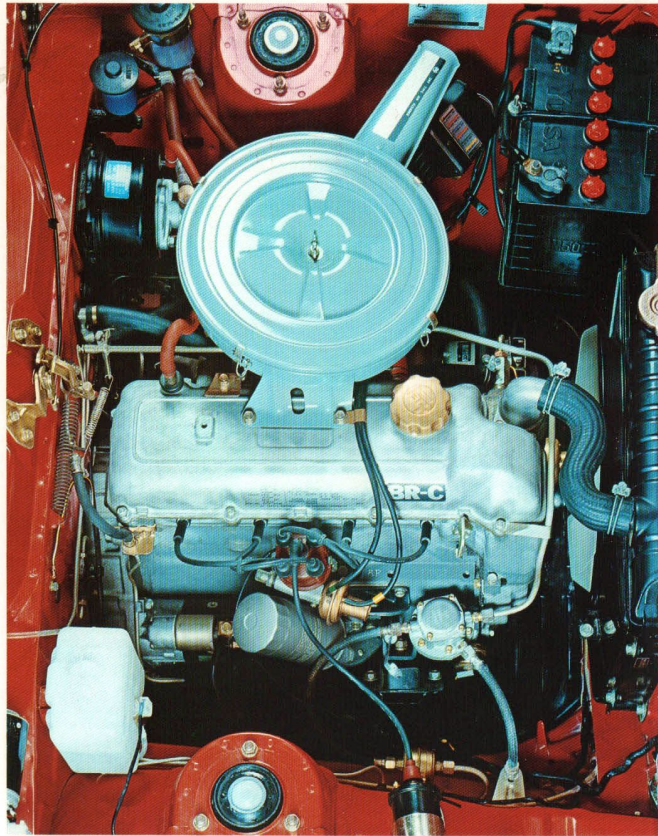

SOHC 4-in-line engine.



Outside driver's side rear-view mirror (standard). Racing stripes on both sides (standard).



Collapsible safety steering column.

Recirculating-ball steering.



Fully lined trunk comes with complete tool set (standard).



Heated rear window (standard).



Radial tires (standard).

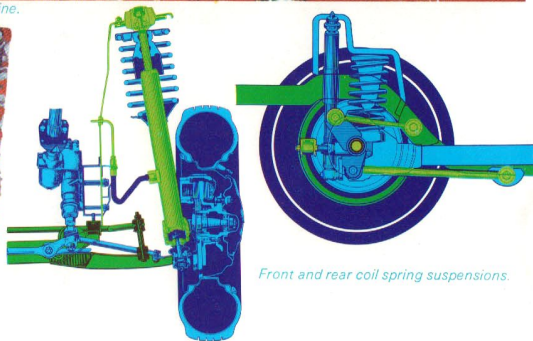

Front and rear coil spring suspensions.

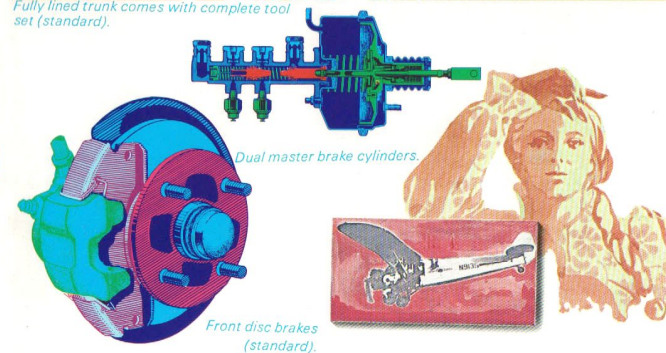

Dual master brake cylinders

Front disc brakes (standard).

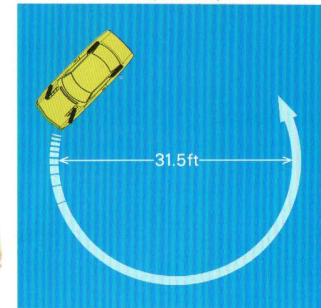

31.5-foot turning circle.

Celica is built for safety. Power-assisted front disc brakes with self-adjusting rear drums for fade-free, straight-line stops. Hydraulic brake lines that resist corrosion. 3-point (harness) seat belts with push-button buckles up front; 2-point (across the lap) seat belts in back. Celica's engine is a 4 cylinder in-line overhead cam engine. This means it has fewer moving parts.

And fewer moving parts means less friction and a longer, more trouble-free life for your engine. In addition, Celica's engine has 5 main bearings. Maximum hp is a solid 108. So you can cruise at 87 mph, and still have power to spare. But if we're big on power, we're still a little stingy on gas. (About 30.2 miles per gallon stingy.)

Celica also has a hood that opens wide, making the engine compartment readily accessible. And a special utility light with a long extension cord. And then there are radial-ply tires with our super-sporty wheel covers. (Radial-ply tires give you longer mileage and grip the road in all kinds of weather.) Our rear window even comes fitted with

heating wires to defrost the frost. And as for our trunk, it provides fully-lined hideaway space, not to mention a jack and tool set. The Toyota Celica ST: one of the nicest things you can do for yourself.

## SPECIFICATIONS

**ENGINE** Type: 4 cyl. in line. SOHC.  
Displacement: 113.4 cubic inches.  
Bore & stroke: 3.39 x 3.15 inches.  
Compression ratio: 9.0 to 1.  
Maximum horsepower: 108 at 5500rpm.  
Maximum torque: 117ft.-lb. at 3600rpm.  
Carburetor: Down-draft 2-barrel  
with automatic choke.

### ELECTRICAL SYSTEM

Battery: 12 volt 60 amp. hour.  
Alternator: 12 volt 480 watts.

**TRANSMISSION** 4-speed all-  
synchronesh, manual transmission.  
Ratios: 1st, 3.579; 2nd, 2.081; 3rd,  
1.397; 4th, 1.000; reverse, 4.399.

**REAR AXLE** Ratio: 3.700 to 1.

**SUSPENSIONS** Front: Independent  
strut type coil springs, telescopic shock  
absorbers, short-strut torsion bars

and anti-sway bar.  
Rear: Coil springs with 4 longitudinal  
links, lateral track bar and telescopic  
shock absorbers.

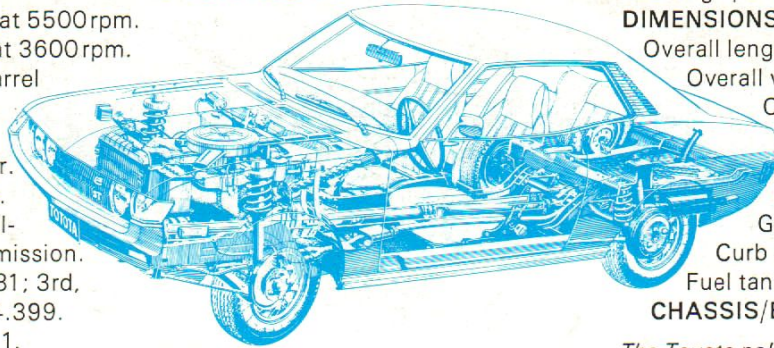

**STEERING** Type: Recirculating ball.  
Ratio: 18~20.5 to 1.  
Turning circle: 31.5ft.

**BRAKES** Front disc, rear drum-power assisted  
**TIRES** Radial, 165SR-13.

**PERFORMANCE** Max. speed: 110mph.  
Cruising speed: 87mph.

### DIMENSIONS, WEIGHT & CAPACITY

Overall length: 163.9 inches.  
Overall width: 63.0 inches.  
Overall height: 51.6 inches.  
Tread: Front, 50.4 inches;  
Rear, 50.6 inches.  
Wheelbase: 95.5 inches.  
Ground clearance: 6.9 inches.  
Curb weight: 2270lbs.  
Fuel tank capacity: 13.2 gallons.

**CHASSIS/BODY** Unit construction.

*The Toyota policy of continual improve-  
ment in design and manufacture requires  
specifications, equipment and price be  
subject to change without notice.*



*There are over 850 Toyota dealers from coast to coast  
equipped to provide expert service and genuine Toyota parts.  
In addition, seven large, strategically located parts depots  
insure fast replenishment of dealer stocks anywhere in the U.S.  
So wherever you drive your Toyota, you can count  
on dependable service. With service as with  
manufacturing, Toyota is quality oriented.*

**TOYOTA**  
*We're quality oriented*